



Hard Rock Miner's Handbook

STANTEC CONSULTING

Hard Rock Miner's Handbook

by Jack de la Vergne

TITLE

Hard Rock Miner's Handbook, Edition 5
Copyright © 2008 Stantec Consulting Ltd.
10160 – 112 Street • Edmonton, Alberta • Canada
Phone (780) 917-7000 • Fax (780) 7330

Hard Rock Miner's Handbook, Edition 3
Copyright © 2003 McIntosh Engineering Limited
147 McIntyre St. West, Suite 200 • North Bay, Ontario • Canada
Phone (705) 494-8255 • Fax (705) 474-2652

Copyright © 2003 McIntosh Engineering Inc
1438 West Broadway Road, Suite 101 • Tempe, Arizona • USA
Phone (480) 831-0310 • Fax (480) 831-0317

AUTHOR

J.N. de la Vergne

SPONSOR

Scott L. McIntosh

EDITOR

Susan L. Andersen

PUBLISHER*

Stantec Consulting

*Also published in CD format and available for download from www.stantec.com/mining

PRINTER AND BOOKBINDER

O'Neil Printing (Phoenix, Arizona), Roswell Bookbinding (Phoenix, Arizona)

ISBN

ISBN 0-9687006-1-6

RIGHTS

All rights reserved. No part of this publication may be reproduced, stored, or transmitted in any form or by any means, electronic, mechanical, photocopying, recording or otherwise, without the prior written permission of the author.

EDITIONS

Edition 1 – June 2000 – Hard Copy

Edition 2 – July 2000 – CD and Web

Edition 3 (CD/Web) – May 2003 – CD and Web

Edition 3 (Hard Copy) – August 2003 – Hard Copy

Edition 4 (CD/Web) – September 2012 – CD and Web

Edition 4 (Hard Copy) – September 2012 – Hard Copy

Edition 5 (CD/Web) - January 2014 - CD/Web

Foreword

Edition 5, January 2014

by Scott McIntosh, Stantec

John (Jack) de la Vergne's *Hard Rock Miner's Handbook* is a work of the heart. Jack—whose 40+ year career spanned engineering, construction, and operation of mining projects worldwide—conceived of and wrote the first edition of the *Handbook*, published in June 2000, to assist miners and engineers in the difficult world of hard rock mining. It was his gift to an industry that provided him with employment, challenges, and fascination.

The *Handbook* is a not-for-profit publication intended to help the mining companies we serve, as well as the mining community at large—students, teachers, consultants, contractors, manufacturers, salespeople, media representatives, financial institutions, mining associations, and government officials. Although it emphasizes metal mining, much of the information is also valuable to our friends mining soft and other not-so-soft industrial mineral and energy resources.

I personally know the lifetime of effort that Jack put into Edition 1. Although I helped him with sponsorship and encouragement, Jack did all of the real work and I never believed we would consider publishing an update, let alone a fourth edition twelve years down the road. A lot has changed since Edition 1—Jack retired and McIntosh Engineering was acquired by Stantec in 2008—but Jack's legacy lives on in Edition 4 of a book that continues to serve the mining community.

RULES OF THUMB: THE “ART” (EXPERIENCE) OF THE MINING INDUSTRY

One attraction of the mining industry is the fact that, although our business is based on sound scientific principles, there is still significant “art” to the work we do. This art is the exciting part of our business. We don't truly know what the ground will be like until it is mined, and by then, if the art has not been prudently applied, it is too late for the application of scientific principles. Because of the unknowns, we often rely on the experience of others and good rules of thumb to guide us.

Rules of thumb and comparable data are often sufficient to provide immediate, approximate answers to kick-start the problem solving process. Consequently, mining industry experts initially compiled and published many rules of thumb, which we delivered at mining conventions across North America. The mining community's strong response provided many new rules and encouraged us to pursue this *Handbook* as a separate project. Although certain contents in the *Handbook* may be controversial, its “Rules of Thumb” and “Tricks of the Trade” sections capture the art (experience) of the mining industry. I encourage you to use the *Handbook*, and use it wisely.

RESPONSE

Mining industry response to the book continues to be incredible. Thanks in large part to the efforts by John Chadwick of the *Mining Journal*, www.infomine.com, and many other members of the mining community, the *Hard Rock Miner's Handbook* has been distributed to over 113 countries worldwide. Web hits and downloads continue as students and professors, miners, engineers, and mining executives embrace the *Handbook* as an invaluable source of practical mining information.

After the first edition was published as a hard copy, we received significant encouragement from the many readers of the book, who provided new additions to the “Rules of Thumb” section. Therefore, Jack decided that a complete update was warranted, and I was on board. The original publication was published as a hard copy. The CD and web version, with minor changes, were published as Edition 2. Two hundred hard copies were distributed to customers and close friends of Stantec (then McIntosh Engineering) and thousands of electronic copies were freely distributed via CD and our website. Edition 3 consisted of two versions, a CD (May 2003) and hard copy (August 2003).

And now we have completed Edition 4, which provides a visual “refresh” to acknowledge Stantec's acquisition of McIntosh Engineering. As it has been for 12 years, the *Handbook* is available as a free download from our website (www.stantec.com/mining) and the CD version is free by request (marketing@stantec.com). We are also printing copies of this new edition, available for a nominal charge to cover printing costs.

ACKNOWLEDGMENTS

Stantec gratefully acknowledges everyone who contributed to the development of the *Hard Rock Miner's Handbook*. Many people are listed as contributors of specific "Rules of Thumb" or "Tricks of the Trade." In addition, we are grateful to everyone who advised Jack on a personal basis through his years of writing the text. I am also personally grateful to the many employees of Stantec and others outside of our company who contributed time to the section-by-section internal review process and updates. Thank you!

In closing, I would like to express my sincere appreciation to John (Jack) de la Vergne for his dedication to this project. I have known and worked with Jack for nearly 30 years and thoroughly enjoyed the opportunity to participate with him in publishing this *Handbook*. To all of our mining industry friends, please feel free to use this *Handbook* wisely and share it with others. I hope that by publishing this *Handbook*, we have somehow made your jobs easier or helped you in some way to be competitive in a tough but fun and interesting industry. We look forward to any comments you have.



Scott McIntosh, September 2012
Stantec Consulting

DISCLAIMER

The *Handbook* is intended as an educational resource that provides information to its readers. Use of the *Handbook* is not intended as a substitute for the standard of care, skill and diligence that would normally have to be provided by an experienced and prudent engineer supplying services in any mining project. The author and the publisher were not engaged to render any type of professional opinion or advice. The content of each rule or tip is the expression and opinion of its author and not necessarily that of the publisher. No warranties or guarantees are expressed or implied by the publisher's choice to include any of the content in this volume. Neither the publisher nor the authors shall be liable to any person or entity for any damage to property, losses, physical, emotional, financial or commercial damages, including but not limited to special, incidental, consequential or other damages. The author and publisher are providing you with information so that you can chose, at your own risk, how to apply and use that information. Every mine or mining project is different and the information contained herein may not be suitable for all particular circumstances.

Where practical, direct quotes of the individuals referenced are provided; however, some were translated from a foreign language, others are recalled from memory, received by word of mouth or do not represent word for word quotes. Every effort was made to ensure that the quotes are accurate. However, the author and publisher are not liable for any errors, omissions, misinterpretations or incorrectly referenced quotes.

Although the author and publisher have made every effort to ensure that the information in this book was correct at the time of first publication, the author and publisher are not liable to any person or entity for any loss, damage, or disruption caused by errors or omissions, whether such errors or omissions result from negligence, accident, or any other cause.

References are provided for informational purposes only and do not constitute endorsement of any websites or other sources. Certain links within the book lead to resources maintained by third parties over whom the author and publisher have no control, and the author and publisher make no representations or warranties as to the accuracy of those resources. Readers should be aware that the websites listed in this book may change and the author and publisher are not liable for any missing or broken links.

Hard Rock Miner's Handbook

Rules of Thumb

Tricks of the Trade

Case Histories

Example Problems

Long before science and engineering evolved, Rules of Thumb constituted the sole body of mining knowledge. In 1891, the Royal Commission on mineral resources in Ontario, Canada stated that we had been “mining by rules of thumb for long enough.” The Royal Commission probably never imagined that over 100 years later we not only continue to employ these tools, but we lend more value to them than ever before.

Exploration Geology and Ore Reserves

Rock Mechanics

Mining Methods

Mine Layout

Environmental Engineering

Feasibility Studies

Mineral Economics

Cost Estimating

Shaft Design

Shaft Sinking

Lateral Development and Ramps

Collars and Portals

Drum Hoists

Koepe / Friction Hoists

Wire Ropes, Sheaves, and Conveyances

Headframes and Bins

Conveyors and Feeders

Ventilation and Air Conditioning

Compressed Air

Mine Dewatering

Backfill

Explosives and Drilling

Electrical

Passes, Bins, and Chutes

Crushers and Rockbreakers

Mineral Processing

Infrastructure and Transportation

Mine Maintenance

Project Management

Table of Contents

1.0	EXPLORATION GEOLOGY AND ORE RESERVES	2
1.1	INTRODUCTION	2
1.2	RULES OF THUMB.....	2
1.3	TRICKS OF THE TRADE.....	3
1.4	DIAMOND DRILLING	4
1.5	ORE RESERVES	5
1.6	EVALUATING EXPLORATION PROPERTIES.....	6
1.7	ESTIMATING ORE RESERVES	6
1.8	UNDERGROUND EXPLORATION ENTRIES.....	7
1.9	MINE ENTRY COMPARISONS	9
1.10	TABLES.....	11
2.0	ROCK MECHANICS.....	13
2.1	INTRODUCTION.....	13
2.2	RULES OF THUMB.....	13
2.3	TRICKS OF THE TRADE.....	15
2.4	THE ROLE OF ROCK MECHANICS	16
2.5	ROCK STRESS	17
2.5.1	Virgin (in situ) Ground Stress.....	17
2.5.2	Induced Ground Stress	18
2.6	GROUND CONTROL	20
2.7	STABILITY OF EXCAVATIONS.....	23
2.8	ROCKBURSTS.....	26
2.8.1	Causes of Rockbursts	26
2.8.2	Combating Rockbursts.....	27
2.8.3	Simple Truths about Rockbursts.....	28
2.8.4	Anecdotes of Rockburst Experiences	34
2.9	ACKNOWLEDGEMENT	34
3.0	MINING METHODS	35
3.1	INTRODUCTION.....	35
3.2	RULES OF THUMB.....	35
3.3	TRICKS OF THE TRADE.....	36
3.4	MINING METHOD SELECTION.....	37
3.5	DILUTION	38
3.6	MINE PLANNING	39
3.7	MINING METHODS FOR LARGE CAPACITY UNDERGROUND MINES	40
4.0	MINE LAYOUT	42
4.1	INTRODUCTION.....	42
4.2	RULES OF THUMB.....	42
4.3	TRICKS OF THE TRADE.....	44
4.4	STRATEGY FOR UNDERGROUND MINES	45
5.0	ENVIRONMENTAL ENGINEERING	47
5.1	INTRODUCTION.....	47
5.2	RULES OF THUMB.....	47
5.3	TRICKS OF THE TRADE.....	48
5.4	PROCEDURES	49
5.5	ENVIRONMENTAL IMPACT STATEMENT	49

5.6	SCHEDULE	50
5.7	ACID ROCK DETERMINATION.....	50
5.8	DRAINAGE DITCHES AND CULVERTS.....	51
5.9	WATER DEMAND	52
5.10	CHLORINATION OF POTABLE WATER	52
5.11	RECYCLING MINE WATER	53
5.12	SMELTER EMISSIONS.....	53
5.13	CYANIDE.....	53
6.0	FEASIBILITY STUDIES.....	54
6.1	INTRODUCTION.....	54
6.2	RULES OF THUMB.....	54
6.3	TRICKS OF THE TRADE.....	55
6.4	ORDER-OF-MAGNITUDE FEASIBILITY ESTIMATE	56
6.5	PRELIMINARY FEASIBILITY STUDY	57
6.6	DETAILED FEASIBILITY STUDY	57
7.0	MINERAL ECONOMICS.....	66
7.1	INTRODUCTION.....	66
7.1.1	Accounting Practice	66
7.1.2	Commodity Market.....	66
7.1.3	Financing.....	66
7.1.4	Economic Evaluation.....	66
7.2	RULES OF THUMB.....	67
7.3	TRICKS OF THE TRADE.....	68
7.4	ECONOMIC EVALUATION	68
7.4.1	Cash Flow	68
7.4.2	Rate of Return on Investment	70
7.4.3	Payback	70
7.4.4	Competitive Cost.....	71
7.5	OPERATING MINE ECONOMICS.....	71
7.6	APPENDIX	72
8.0	COST ESTIMATING	73
8.1	INTRODUCTION.....	73
8.2	RULES OF THUMB.....	73
8.3	KEY DEFINITIONS AND ABBREVIATIONS.....	74
8.4	PROCEDURE	75
8.5	TOOLS OF THE TRADE	75
8.6	TRICKS OF THE TRADE.....	76
8.7	CATEGORIES AND CONFIDENCE LEVELS OF ESTIMATES.....	76
8.8	VALUE ENGINEERING.....	77
8.9	CALCULATION OF INTEREST COSTS.....	77
8.10	THE “SIX-TENTHS RULE”	78
8.11	JACK’S FACTORS.....	78
8.12	LANG FACTORS.....	78
8.13	CALCULATION OF EPCM COSTS	79
8.14	OPERATING COST BREAKDOWN.....	80
8.15	CALCULATION OF PRODUCTIVITY – TYPICAL VALUES.....	80
8.16	CALCULATION OF CONSUMPTION – TYPICAL VALUES.....	81
9.0	SHAFT DESIGN	82
9.1	INTRODUCTION.....	82
9.2	RULES OF THUMB.....	82
9.3	TRICKS OF THE TRADE.....	85
9.4	FUNCTION OF CONCRETE LINING IN A CIRCULAR SHAFT	86
9.4.1	Curb Rings	86
9.4.2	Continuous Lining	86

9.4.3	Role of Lining	87
9.4.4	Concrete Lining Advantages	87
9.5	STIFFNESS OF CONCRETE	87
9.6	STIFFNESS OF ROCK	87
9.7	CONCRETE LINER DESIGN	88
9.8	STEEL LINER DESIGN	89
9.8.1	Sandwich Liner.....	89
9.8.2	Leaky Liners.....	90
9.8.3	Hydrostatic Liner	90
9.9	SHAFT DESIGN TOLERANCES	91
10.0	SHAFT SINKING	92
10.1	INTRODUCTION.....	92
10.2	RULES OF THUMB.....	92
10.3	TRICKS OF THE TRADE.....	94
10.4	TYPES OF SHAFTS.....	95
10.5	PLANNING AND PREPARATIONS – RECIPE FOR SUCCESS.....	95
10.6	HOIST SELECTION FOR SHAFT SINKING	96
10.7	SHAFT CONCRETE.....	96
10.7.1	Coriolus Effect.....	97
10.8	SOLVED PROBLEMS.....	97
10.8.1	Coriolus Effect.....	97
10.8.2	Overbreak Measurement	97
11.0	LATERAL DEVELOPMENT AND RAMPS	99
11.1	INTRODUCTION.....	99
11.2	RULES OF THUMB.....	99
11.3	TRICKS OF THE TRADE.....	100
11.4	TRACK VERSUS TRACKLESS.....	101
11.5	DESIGN AND FUNCTION OF LATERAL HEADINGS	102
11.6	LASER CONTROLS.....	102
12.0	COLLARS & PORTALS	104
12.1	INTRODUCTION.....	104
12.2	RULES OF THUMB.....	104
12.3	TRICKS OF THE TRADE.....	105
12.4	WELL POINTS AND WELL PUMP DEWATERING.....	108
12.5	BIG HOLE DRILLING.....	109
12.6	GROUND FREEZING.....	109
13.0	DRUM HOISTS	114
13.1	INTRODUCTION.....	114
13.2	RULES OF THUMB.....	114
13.3	TRICKS OF THE TRADE.....	117
13.4	HOIST CYCLE TIME “T”	118
13.4.1	Stops	119
13.4.2	Creep Times.....	119
13.5	MAXIMUM LINE SPEEDS FOR DRUM HOISTS.....	120
13.5.1	Case Histories.....	120
13.6	PRODUCTION AVAILABILITY	121

14.0	KOEPE / FRICTION HOISTS	125
14.1	INTRODUCTION.....	125
14.2	RULES OF THUMB.....	125
14.3	TRICKS OF THE TRADE.....	127
14.4	FRICTION HOIST DESIGN	128
14.5	TENSION RATIO.....	130
14.6	PRODUCTION AVAILABILITY	131
14.7	COMPARISONS	133
15.0	WIRE ROPES, SHEAVES, AND CONVEYANCES	135
15.1	INTRODUCTION.....	135
15.2	RULES OF THUMB.....	135
15.3	TRICKS OF THE TRADE.....	136
15.4	CHARACTERISTICS OF WIRE ROPES	138
15.5	DIAMETER OF WIRE ROPES	138
15.6	SAFETY FACTORS FOR WIRE ROPES.....	138
15.7	SELECTION OF WIRE ROPES	139
15.8	SELECTING ROPE ATTACHMENTS.....	139
15.9	MINIMUM DRUM AND SHEAVE DIAMETERS	140
15.10	TYPICAL SKIP FACTORS FOR MINE HOISTS.....	140
15.11	CLEARANCES AND RUB ROPE REQUIREMENTS FOR ROPE GUIDED HOISTING SHAFTS	141
15.12	ROPE STRETCH FOR SKIP HOIST ROPES	141
16.0	HEADFRAMES AND BINS	143
16.1	INTRODUCTION.....	143
16.2	RULES OF THUMB.....	143
16.3	TRICKS OF THE TRADE.....	144
16.4	STEEL HEADFRAME VERSUS CONCRETE HEADFRAME	145
16.5	WEIGHT OF A STEEL HEADFRAME	145
16.6	HEIGHT OF A STEEL HEADFRAME	146
17.0	CONVEYORS AND FEEDERS	149
17.1	INTRODUCTION.....	149
17.2	RULES OF THUMB.....	149
17.3	TRICKS OF THE TRADE.....	150
17.4	BELT CONVEYOR DESIGN	152
17.5	CONVEYOR BELT WIDTH.....	153
17.6	CASE HISTORIES.....	153
17.7	POWER REQUIREMENTS	154
17.8	COMPUTER PROGRAM	155
17.9	PRODUCTION CAPACITY	155
17.10	FRICTION AROUND A CIRCULAR DRIVE	156
17.11	FEEDER SELECTION AND DESIGN.....	156
18.0	VENTILATION AND AIR CONDITIONING	157
18.1	INTRODUCTION.....	157
18.2	RULES OF THUMB.....	158
18.3	TRICKS OF THE TRADE.....	161
18.4	CONVERSION FACTORS	163
18.5	CONSTANTS AND TYPICAL VALUES.....	164
18.6	DESIGN OF THE PRIMARY VENTILATION CIRCUIT	164
18.7	NATURAL VENTILATION.....	165
18.8	DESIGN OF VENTILATION SHAFTS AND RAISES.....	165
18.9	FRICTION FACTOR FOR AN EQUIPPED MINESHAFT.....	166
18.10	VENTILATION DUCT DESIGN.....	169
18.11	SELECTION OF ELECTRIC POWERED VENTILATION FANS	170
18.12	AIR FANS.....	170

18.13	TESTING VENTILATION FAN PERFORMANCE	170
18.14	THRESHOLD LIMIT VALUE.....	171
18.15	DIESEL PARTICULATE MATTER.....	172
18.16	HEAT GENERATED BY THE AUTO-COMPRESSION OF AIR.....	172
18.17	VENTILATION MANAGEMENT IN THE OPERATING MINE	173
18.18	THE REQUIRED CAPACITY OF A MINE AIR HEATER	173
18.19	HEAT LOAD.....	174
18.20	COOLING	174
18.21	MECHANICAL REFRIGERATION	175
19.0	COMPRESSED AIR	178
19.1	INTRODUCTION.....	178
19.2	RULES OF THUMB.....	179
19.3	TRICKS OF THE TRADE.....	180
19.4	AIR LINE DIAMETER	180
19.5	AIR LINES LEAKS.....	181
19.6	AIR RECEIVER.....	182
19.7	COOLING WATER	182
19.8	EQUIPMENT AIR REQUIREMENTS.....	182
19.9	COMPRESSED AIR PLANT CAPACITY.....	183
19.10	ALTITUDE AND DEPTH.....	185
20.0	MINE DEWATERING.....	187
20.1	INTRODUCTION.....	187
20.2	RULES OF THUMB.....	188
20.3	TRICKS OF THE TRADE.....	189
20.4	SOURCE OF SLIMES.....	190
20.5	THE WATER BALANCE	190
20.6	ESTIMATING AND MEASURING WATER FLOWS.....	191
20.7	CLEAR WATER PUMPING	192
20.8	DIRTY WATER PUMPING	192
20.9	DRAINAGE TUNNELS.....	193
20.10	CENTRIFUGAL PUMP SELECTION.....	194
20.11	FRICTION HEAD LOSS IN STEEL PIPE.....	196
20.12	MINIMUM WALL THICKNESS OF PIPING	197
20.13	SETTLING VELOCITY	198
20.14	UNDERGROUND DAM DESIGN	199
21.0	BACKFILL	201
21.1	INTRODUCTION.....	201
21.2	RULES OF THUMB.....	202
21.3	TRICKS OF THE TRADE.....	203
21.4	TYPES OF BACKFILL	204
21.5	PROPERTIES	206
21.6	CASE HISTORIES.....	206
21.7	COOLING FROM PASTE FILL	207
22.0	EXPLOSIVES AND DRILLING.....	209
22.1	INTRODUCTION.....	209
22.2	RULES OF THUMB.....	209
22.3	TRICKS OF THE TRADE.....	211
22.4	EXPLOSIVE SELECTION AND TYPES	212
22.5	CRATER BLASTING	212

22.6	SULFUR BLASTS.....	213
22.7	DRILLING BLASTHOLES.....	213
22.8	DRILL PATTERNS.....	213
23.0	ELECTRICAL	215
23.1	INTRODUCTION.....	215
23.2	RULES OF THUMB.....	215
23.3	TRICKS OF THE TRADE.....	216
23.4	NOMENCLATURE	218
23.5	LAWS AND FORMULAE	218
23.6	POWER FACTOR.....	218
23.7	ELECTRICAL DEMAND.....	219
23.8	POWER CONSUMPTION AND COST ESTIMATE.....	220
23.9	STANDARD ELECTRICAL MOTOR SIZES.....	223
23.10	FULL LOAD CURRENT FOR AC AND DC MOTORS	223
23.11	TRANSMISSION LINE DATA.....	224
23.12	GROUNDING AND BONDING.....	224
23.13	RATINGS OF MOTOR CIRCUIT FUSES AND BREAKERS.....	225
23.14	FUSE RATINGS REQUIRED FOR MOTOR APPLICATIONS.....	226
23.15	WORLDWIDE POWER GRID SUPPLY SYSTEM FREQUENCIES	227
23.16	WORLDWIDE POWER GRID SUPPLY SYSTEM VOLTAGES	228
24.0	PASSES, BINS, AND CHUTES	229
24.1	INTRODUCTION.....	229
24.2	RULES OF THUMB.....	229
24.3	TRICKS OF THE TRADE.....	230
24.4	ORE PASS INCLINATION.....	231
24.5	ORE PASS SIZE.....	231
24.6	ORE PASS LININGS.....	232
24.7	ORE PASS STABILITY.....	233
24.8	DAMAGE CONTROL.....	233
24.9	THE PERFECT ORE PASS	233
24.10	GLORY HOLE ORE PASSES.....	234
24.11	FILL RAISES	235
24.12	BINS	235
24.13	CHUTES.....	235
25.0	CRUSHERS AND ROCKBREAKERS	236
25.1	INTRODUCTION.....	236
25.2	RULES OF THUMB.....	237
25.3	TRICKS OF THE TRADE.....	239
25.4	JAW CRUSHERS	240
25.5	GYRATORY CRUSHERS.....	242
25.6	CONE CRUSHERS.....	242
25.7	JAW CRUSHER VERSUS GYRATORY CRUSHER	242
25.8	LOCATING A PRIMARY CRUSHER UNDERGROUND.....	243
25.9	DUST COLLECTION.....	243
25.10	CRUSHING WASTE ROCK.....	244
25.11	ROCKBREAKERS.....	244
26.0	MINERAL PROCESSING.....	245
26.1	INTRODUCTION.....	245
26.2	RULES OF THUMB.....	246
26.3	TRICKS OF THE TRADE.....	248
26.4	GRINDING	250
26.5	BENEFICIATION.....	253

27.0	INFRASTRUCTURE AND TRANSPORTATION	256
27.1	INTRODUCTION.....	256
27.2	RULES OF THUMB.....	256
27.3	TRICKS OF THE TRADE.....	257
27.4	HAUL ROADS	259
27.5	RAILWAYS.....	261
27.6	LAND DRAINAGE AND CULVERTS	261
27.7	AIRCRAFT PAYLOAD CAPACITIES.....	262
28.0	MINE MAINTENANCE.....	263
28.1	INTRODUCTION.....	263
28.2	RULES OF THUMB.....	263
28.3	TRICKS OF THE TRADE.....	264
28.4	MANAGEMENT AND ADMINISTRATION.....	265
28.5	WORK PRACTICE.....	269
28.6	OPERATING ENVIRONMENT	277
28.7	MAINTENANCE FOR SMALL MINES	278
28.8	APPENDIX	279
28.8.1	Logs and Certificates	279
28.8.2	Sample Work Standard.....	280
28.8.3	Work Standards Abbreviations	281
28.8.4	Mine Hoist Lubricants.....	281
28.8.5	Mine Hoist Tools, Equipment, and Supplies	282
29.0	PROJECT MANAGEMENT	283
29.1	INTRODUCTION.....	283
29.2	STRATEGIC PLANNING	283
29.3	SYSTEMS AND PROCEDURES	284
29.4	EXECUTION.....	285
APPENDIX I – PROPERTIES OF MISCELLANEOUS MATERIALS	291	
I.1	FUELS	291
I.2	MODULUS OF ELASTICITY, E	291
I.3	MINE TIMBERS AND POSTS	292
I.4	PROPERTIES AND MEASUREMENT OF GOLD.....	293
APPENDIX II – STATISTICAL TOOLS.....	295	
II.1	STANDARD CHARTS.....	295
APPENDIX III DIRECTORY OF WEB SITES.....	297	
APPENDIX IV – CONVERSION FACTORS AND CONSTANTS	300	
APPENDIX V – BASIC TECHNICAL LIBRARY	307	
INDEX	310	

List of Tables

TABLE 1-1 CORE AND DRILL HOLE DIAMETERS	4
TABLE 1-2 CATEGORIES OF CERTAINTY	5
TABLE 1-3 GEOLOGIC TIME	11
TABLE 1-4 MOHS' SCALE FOR MINERAL HARDNESS	11
TABLE 1-5 MOHS' SCALE FOR ROCK HARDNESS	12
TABLE 2-1 RESISTANCE VALUE COMPARISON	21
TABLE 2-2 TABLE OF OBSERVATIONS (FACTS)	25
TABLE 2-3 COMPRESSIVE STRENGTH	27
TABLE 2-4 RECORD OF ROCKBURSTS FROM A LARGE CANADIAN MINE (EIGHT-YEAR PERIOD)	30
TABLE 3-1 MINING METHODS FOR SOME OF THE WORLD'S LARGEST CAPACITY UNDERGROUND MINES	40
TABLE 4-1 ORE TRANSPORT METHODS EMPLOYED AT UNDERGROUND MINES	45
TABLE 5-1 ENVIRONMENTAL IMPACT STATEMENT CASE STUDY	50
TABLE 5-2 PRECIPITATION OF COMMON METAL IONS	51
TABLE 5-3 FLOW CAPACITY	51
TABLE 5-4 CULVERT ENTRANCE CAPACITY	52
TABLE 5-5 WATER DEMAND	52
TABLE 5-6 CHLORINATION QUANTITIES	52
TABLE 6-1 METAL REDUCTION FACTORS	56
TABLE 8-1 ENGINEERING, PROCUREMENT, AND CONSTRUCTION MANAGEMENT VALUES	79
TABLE 8-2 APPROXIMATE MINING COST BREAKDOWN	80
TABLE 8-3 CALCULATION OF PRODUCTIVITY – TYPICAL VALUES	80
TABLE 8-4 CALCULATION OF CONSUMPTION ² – TYPICAL VALUES	81
TABLE 9-1 STIFFNESS OF COMMON ROCKS IN GPA	88
TABLE 10-1 SELECTION (DIAMETER) OF DOUBLE-DRUM HOIST FOR SHAFT SINKING	96
TABLE 12-1 APPROXIMATE UNCONFINED COMPRESSIVE STRENGTHS OF FROZEN GROUND	110
TABLE 12-2 FREEZE PIPE SPACING (1)	112
TABLE 12-3 FREEZE PIPE SPACING (2)	113
TABLE 12-4 VISCOSITY COMPARED TO TEMPERATURE	113
TABLE 13-1 HOISTING SPEEDS ON WOOD GUIDES – EXCEEDING 10M/S (2,000 FPM)	120
TABLE 13-2 HOISTING SPEEDS ON FIXED GUIDES (STEEL), EXCEEDING 15M/S (3,000 FPM)	121
TABLE 13-3 HOIST PLANT AVAILABILITY – DOUBLE-DRUM HOIST (SEVEN DAYS PER WEEK OPERATION)	122
TABLE 14-1 HOIST PLANT AVAILABILITY	131
TABLE 15-1 HOISTING SPEEDS LESS THAN 1M/S	140
TABLE 15-2 SKIP FACTORS	141
TABLE 16-1 HEIGHT OF STEEL HEADFRAME FOR A 10-FOOT (3M) DOUBLE DRUM PRODUCTION HOIST	148
TABLE 17-1 BELT CONVEYORS AT CANADIAN MINES	153
TABLE 17-2 EQUIVALENT LIFT FOR BELT CONVEYOR LENGTHS	154
TABLE 18-1 CONVERSION FACTORS	163
TABLE 18-2 CONSTANTS AND VALUES	164
TABLE 18-3 DIAMETERS FOR CIRCULAR SHAFTS AND RAISES	166

TABLE 18-4 CASE HISTORIES.....	169
TABLE 18-5 VENTILATION DUCT DIAMETERS.....	169
TABLE 18-6 AIR FAN AIRFLOW.....	170
TABLE 18-7 TYPICAL TLV'S FOR CONTAMINANTS AND RESPIRABLE DUSTS.....	171
TABLE 18-8 HEAT BALANCE.....	174
TABLE 18-9 MINE VENTILATION CAPACITY.....	175
TABLE 18-10 CASE HISTORIES OF DEEP HOT MINING OPERATIONS.....	177
TABLE 19-1 TYPICAL COMPRESSED AIR REQUIREMENTS.....	182
TABLE 19-2 EQUIPMENT AIR CONSUMPTION.....	184
TABLE 19-3 STANDARD ATMOSPHERE AT ALTITUDES/DEPTHS AND AIR COMPRESSED TO 100PSIG (689 kPa) AT SEA LEVEL.....	186
TABLE 20-1 UNDERGROUND MINE WATER BALANCE.....	190
TABLE 20-2 FLOW RATES (USGPM).....	191
TABLE 20-3 FLOW RATE FROM A 1.38-INCH DIAMETER HOLE.....	191
TABLE 20-4 FLOW RATES FOR AN 8-INCH WIDE WEIR BOX.....	192
TABLE 20-5 STANDARD DRAINAGE TUNNEL CAPACITY.....	193
TABLE 20-6 TRUE AREA OF OUTLET.....	194
TABLE 20-7 STANDARD ELECTRIC MOTORS.....	196
TABLE 20-8 FRICTION HEAD LOSS (FEET) PER 100 FEET OF SCHEDULE 40 STEEL PIPE (MINE SERVICE).....	197
TABLE 20-9 DIMENSIONS OF COMMERCIAL STEEL PIPE.....	198
TABLE 20-10 OVERFLOW DAM DESIGN (METRIC).....	199
TABLE 20-11 OVERFLOW DAM DESIGN (IMPERIAL).....	200
TABLE 21-1 TYPICAL PROPERTIES OF STRUCTURAL BACKFILLS.....	206
TABLE 21-2 TYPICAL PROPERTIES OF HYDRAULIC, CEMENTED BACKFILLS (CHF).....	206
TABLE 21-3 PASTE FILL CASE HISTORIES.....	206
TABLE 21-4 CEMENTED ROCK FILL CASE HISTORIES.....	207
TABLE 23-1 ELECTRICAL NOMENCLATURE.....	218
TABLE 23-2 TABULATION OF ESTIMATED POWER CONSUMPTION AND COST FOR A 2,500 TPD MINE.....	220
TABLE 23-3 KILOWATT-HOUR PER TONNE PROCESSED (TYPICAL VALUES).....	222
TABLE 23-4 STANDARD ELECTRIC MOTOR SIZES.....	223
TABLE 23-5 FULL LOAD CURRENT DATA.....	223
TABLE 23-6 TRANSMISSION LINE DATA.....	224
TABLE 23-7 FUSE AND BREAKER RATINGS (CAN).....	225
TABLE 23-8 FUSE AND BREAKER RATINGS (USA).....	225
TABLE 23-9 REQUIRED FUSE RATINGS.....	226
TABLE 23-10 WORLDWIDE POWER GRID SUPPLY SYSTEM FREQUENCIES.....	227
TABLE 23-11 WORLDWIDE POWER SUPPLY SYSTEM VOLTAGES.....	228
TABLE 26-1 BOND WORK INDEX FOR ROCKS AND MINERALS.....	252
TABLE 26-2 FEED AND PRODUCT SIZES IN MICRONS (μ).....	252
TABLE 27-1 DEGREE AND RADIUS OF CURVATURE.....	259
TABLE 27-2 AIRCRAFT PAYLOAD CAPACITIES.....	262
TABLE 28-1 ENGINE OIL CHANGE INTERVALS.....	270
TABLE 28-2 MEASUREMENTS AND TESTS FOR MOBILE EQUIPMENT PREVENTIVE MAINTENANCE.....	271
TABLE 28-3 MAINTENANCE FUNCTIONS OF MAIN UNDERGROUND SHOPS.....	273
TABLE 28-4 COMPONENT AREAS – MAIN UNDERGROUND SHOP.....	274
TABLE 28-5 STATIONARY AND PORTABLE EQUIPMENT.....	274
TABLE 28-6 STOCK ITEMS.....	275
TABLE 28-7 FURNISHINGS AND SUNDRY ITEMS FOR UNDERGROUND SHOPS.....	276

TABLE 28-8 HAND TOOLS 277

TABLE 28-9 WORK PERFORMANCE STANDARDS ABBREVIATIONS..... 281

TABLE 28-10 MINE HOIST LUBRICANTS 281

TABLE 29-1 COMMISSIONING TROUBLE SHOOTING MATRIX 289

TABLE I-1 PROPERTIES OF COMMON FUELS..... 291

TABLE I-2 MODULUS OF ELASTICITY, E..... 291

TABLE I-3 PROPERTIES OF MINE TIMBERS AND POSTS 292

TABLE I-4 GOLD PROPERTIES 293

TABLE I-5 GOLD MEASUREMENT 293

TABLE I-6 MEASUREMENT CONVERSION 293

TABLE I-7 GRADE CONVERSIONS 294

List of Figures

FIGURE 2-1 INDUCED STRESSES AROUND SHAFTS	19
FIGURE 2-2 OREBODY SHAPES	29
FIGURE 2-3 NUMBER OF EVENTS LARGER PER ANNUM VS. EVENT MAGNITUDE	31
FIGURE 2-4 MAGNITUDE/HAZARD/TIME PLOT FOR SEISMIC EVENTS AT A TYPICAL LARGE MINE	32
FIGURE 2-5 FALLS OF GROUND COMPARED TO ROCKBURSTS	33
FIGURE 3-1 FISHBONE CHART.....	39
FIGURE 4-1 MOVING ORE TO SURFACE	46
FIGURE 18-1 DRAG COEFFICIENTS.....	168
FIGURE 20-1 PORTABLE WEIR BOX IN DITCH.....	192
FIGURE 20-2 RANGE OF EFFICIENCIES	195
FIGURE 20-3 UNDERGROUND DAM DESIGN	199
FIGURE 25-1 JAW CRUSHER TYPES	241
FIGURE 27-1 MELTING POWER OF ROAD SALTS	260

Introduction

“The grand aim of all science is to cover the greatest number of empirical facts by logical deduction from the smallest number of hypotheses or axioms. Most of the fundamental ideas of science are essentially simple, and may, as a rule, be expressed in a language comprehensible to everyone.”

Albert Einstein

Handbooks have long been used in our industry as the principal source of information for the solution of day-to-day problems. The goal of these texts is to present a digest of as much theory and practice as possible. Customarily, the books have been a collation of entries solicited from recognized experts in each of the many separate mining disciplines.

A few mining handbooks were written by individuals. Agricola wrote the first handbook for the mining industry, *“De Re Metalica,”* in the 16th century. In 1909, *“Principles of Mining”* was written by Herbert Hoover, a mining engineer who later became president of the United States. In 1949, Jack Spalding, an English mining engineer, left his job in South Africa to enlist in the army and serve in World War II. He wrote the first draft of his valuable handbook entitled *“Deep Mining”* during the six years that the Japanese held him as a prisoner of war. The camp commander burned his manuscript the day before his release. After the war, a mining company (John Taylor and Sons) sponsored him for one year to allow him to rewrite and publish the book.

When I began the journey of writing the first edition, I expected that others would write many of the chapters, but soon realized this was not going to happen. I did the best I could and my efforts were greatly improved by the constructive criticism and final reviews of employees and friends of Stantec. The resulting book enjoyed immediate and wide acceptance by the mining industry, due in no small part to unrequited promotion by John Chadwick of the Mining Journal.

Edition 3 was written to remedy some of the shortcomings found in the original text, add over 100 new rules of thumb, and generally update the handbook. A new chapter (Project Management) was added to explore managing, controlling, coordinating, and scheduling major mining projects.

The chapters on hoisting, rock mechanics, ventilation, and mineral processing are enhanced by the efforts of four individual experts: Sigurd Grimestad, Richard Brummer, Pierre Mousset-Jones, and Robert Shoemaker. These new friends voluntarily critiqued and/or edited the original text and provided valuable new material.

I am indebted to Scott McIntosh who once again directed the progress of the work, sponsored the extensive editing required, solved a number of difficult problems, and enabled publishing the version of the *Hard Rock Miner’s Handbook* you hold in your hands.

1.0 Exploration Geology and Ore Reserves

1.1 Introduction

Hard rock mining is mainly concerned with metallic ores. The principles of geology and ore reserve estimation described in this chapter have application to all types of mining, but the particulars are curtailed when it comes to placer operations or the mining of industrial minerals, salt, and coal.

The delineation and grade of a hard rock orebody are first made by diamond drilling (as opposed to reverse circulation drilling or test pits). Confirmation (risk reduction) is accomplished if miners subsequently drive an underground entry to complete additional exploration drilling and sampling. Miners use the term "exploration geology" to denote the implementation and interpretation of all this work.

This chapter is mainly concerned with the sequence of events that occur between the discovery of a mineralized *deposit*, through its classification as a mineral *resource*, on to the determination whether and to what extent that it constitutes a mineral *reserve* (mineral resource that may be exploited at a profit).

In recent years, the miner's role has been less concerned with exploration geology and ore reserve estimation. The latter, once the responsibility of a professional mining engineer, is now typically performed by a "geoscientist" (geologist, geological engineer, geochemist, or geophysicist). The change has not occurred without problems. The root cause is commonly believed to be that geo-scientists were not regulated by a professional body and hence could not be held legally responsible for their actions. As a remedy, some Canadian provinces (with the notable exception of Ontario) and a few of the states are now admitting qualified geo-scientists into their associations of professional engineers.

Hence, this chapter does not provide full consideration for geology and reserves, but deals more with driving entries for underground exploration, which is the domain of the miner.

1.2 Rules of Thumb

Discovery

- It takes 25,000 claims staked to find 500 worth diamond drilling to find one mine. *Source:* Lorne Ames
- On average, the time between discovery and actual start of construction of a base metal mine is 10 years; it is less for a precious metal mine. *Source:* J.P. Albers
- On average, the time between discovery and actual start of production of a mine in an established mining district ("brown field") is seven years. *Source:* Sylvain Paradis
- On average, the time between discovery and actual start of production of a mine in a district where there is no previously established mining activity ("green field") is ten years. *Source:* Sylvain Paradis

Costs

- The amount expended on diamond drilling and exploration development for the purposes of measuring a mineral resource should approximately equal 2% of the gross value of the metals in the deposit. *Source:* Joe Gerden

Bulk Sample

- The minimum size of a bulk sample, when required for a proposed major open pit mine is in the order of 50,000 tons (with a pilot mill on site). For a proposed underground mine, it is typically only 5,000 tons. *Source:* Jack de la Vergne

Ore Resource Estimate

- The value reported for the specific gravity (SG) of an ore sample on a metallurgical test report is approximately 20% higher than the correct value to be employed in the resource tonnage calculation. *Source:* Jack de la Vergne
 - To determine an "inferred" or "possible" resource, it is practice to assume that the ore will extend to a distance at least equal to half the strike length at the bottom of measured reserves. Another rule is that the largest horizontal cross section of an orebody is half way between its top and bottom. *Source:* H. E. McKinstry
-

Ore Resource Estimate (continued)

- In the base metal mines of Peru and the Canadian Shield, often a zonal mineralogy is found indicating depth. At the top of the orebody sphalerite and galena predominate. Near mid-depth, chalcopyrite becomes significant and pyrite appears. At the bottom, pyrite, and magnetite displace the ore. *Source:* H. E. McKinstry

- Archean aged quartz veins are generally two times as long as their depth extent, but gold zones within these vein systems are 1/5 - 1/10 as long as their depth extent. *Source:* Gord Yule

- In gold mines, the amount of silver that accompanies the gold may be an indicator of depth. Shallow gold deposits usually have relatively high silver content while those that run deep have hardly any. *Source:* James B. Redpath

- As a rule of thumb, I use that 2P reserves are only such when drill spacing does not exceed five to seven smallest mining units (SMU). Open pit mining on 15m benches could have an SMU of 15m by 15m by 15m. Underground, an SMU would be say 3m by 3m by 3m (a drift round). *Source:* René Marion

- Your thumb pressed on a 200-scale map covers 100,000 tons of ore per bench (height assumed to be 50 feet). *Source:* Janet Flinn

Strike and Dip

- The convention for establishing strike and dip is always the Right Hand Rule. With right hand palm up, open and extended, point the thumb in the down-dip direction and the fingertips provide the strike direction. *Source:* Mike Neumann
-

1.3 Tricks of the Trade

- A likely location for hard rock discovery is near a major intrusion of a coarse-grained igneous rock into another that is fine grained. Discoveries are made within two kilometers of the contact, but not within the intrusive. *Source:* Northern Miner Press.
- Ore bodies with a hydrothermal genesis are often found near the nose of a fold. Folds are identified on maps published by a national geological survey. *Source:* Northern Miner Press.
- Metamorphosed sedimentary piles of argillites, black schist, and calcareous rocks are particularly favorable to a rich gold discovery. *Source:* R. W. Boyle
- Classic volcanic massive sulfide deposits typically occur in districts having a diameter of approximately 32-km. On average, each district contains 12 deposits that all together may contain a total in the order of 5 million tons of metal. Ranked in order of size, the largest deposit typically contains 2/3 of the total metal and the second largest about 1/7. *Source:* Dr. D.F. Sangster
- Prevailing regional cross folding indicates the direction in which a new discovery may be found in the vicinity of one already identified. For example, in the Canadian Shield a new discovery is most likely to be found to the northeast or southwest of an existing orebody. *Source:* S. V. Burr
- An orebody may have been split and separated by post-mineral dykes, sills, or slip faults. Determining the displacement may permit discovery of the "other half" of an orebody. *Source:* Arturo Thomas Novoa
- If you spend a ton of money on underground development at the exploration stage, you can wind up by making a mine out of a project that would otherwise have failed (when it is considered that sunk costs are often not considered in the final economic feasibility study). *Source:* Bill James
- The first sample taken from any serious prospect should be submitted for a complete qualitative analysis to avoid overlooking a valuable metal or mineral content. *Source:* Hal Steacy
- Exploration diamond drilling from surface should penetrate past the zone of mineralization and into the footwall where future mine development may take place. *Source:* Jack de la Vergne
- Drill sufficient condemnation holes to determine the absence of mineralization prior to locating surface facilities (structures, mills, critical access roads, waste dumps, etc.). Typically, the condemnation drilling should be designed with the same criteria used to "prove up" reserves. *Source:* Dana Willis
- An "ore reserve" calculated only from surface drilling is typically based on measurement in two dimensions; the third is assumed. Measurement in three dimensions is required to determine an ore reserve. *Source:* Jack de la Vergne

- Estimation of ore reserves and grades from sample assays based on simple arithmetical averages leads to fundamental error; statistical averaging is required. On the other hand, even sound statistical procedures (e.g. geostatistics) when employed by gifted amateurs can do more harm than good. *Source:* Jack de la Vergne

1.4 Diamond Drilling

The hard rock ore bodies that outcropped on surface were found long ago. Diamond drilling enables the discovery of new ore bodies that outcrop beneath deep soil overburden, under lakes and even those that do not outcrop at all (blind ore bodies).

The role of the diamond drill is not completed with discovery. In hard rock mines, it is the weapon of choice for subsequent exploration drilling required to define the orebody. Later, diamond drilling is employed for definition drilling to locally define an ore outline before actual mining.

The diamond drill extracts a core, important portions of which are photographed then split longitudinally ($\frac{1}{2}$ for assay and $\frac{1}{2}$ permanently retained in storage). Larger diameter cores may be split again to provide separate samples for assay and metallurgical testing. The drilling process returns cuttings (sludge) to the surface to supplement the core assays.

The diamond drill core may be obtained in any one of a number of standard diameters. Larger diameters are preferable but more expensive. The most common sizes employed today for exploration drilling are NQ and CHD 76. Core and drill hole diameters for various bit sizes are provided in Table 1-1.

Table 1-1 Core and Drill Hole Diameters

Bit Size	Core Diameter mm	Hole Diameter mm
AQ	27.0	48.0
BQ	36.5	60.0
NQ	47.6	75.7
HQ	63.5	96.0
PQ	84.0	122.6
CHD 76	43.5	75.7
CHD 101	63.5	101.3
CHD 134	85.0	134.0

1 inch = 25.400mm

Drilling logs provide indices of the rock qualities, including penetration rate, core loss (an indicator of bad ground), loss of return water (indication of a potential inflow of groundwater to future mining), grout take, etc. In addition, all core extracted is separately logged at a core shack. Particular attention is paid to the sections that penetrate the ore and that portion of the footwall where future mine development may take place. Geologists equipped with a bi-polar microscope and portable computer (laptop) perform the logging. The PC software includes a menu of formats, check lists, symbols, abbreviations, and repetitive terminology.

Exploration drilling is performed from surface with holes laid out on a prescribed grid (pattern). The grid orientation conforms to the dip or plunge of the orebody. Grid coordinates are tied to the federal (national) grid system. Collar elevations for each hole are best determined from a benchmark(s) tied to the nearest national geodetic monument. The spacing between holes on the grid is established from the presumed orientation and extent of the orebody. It is convenient to use the same units of dimension (metric or imperial) for the grid spacing as used in the national grid of the host country. A spacing of 200 feet by 200 feet (60m by 60m) is commonly employed.

If the orebody is flat lying or slightly inclined, it is convenient to drill all holes vertically. Parallel, inclined holes are drilled for steeply dipping ore bodies. All drill holes will deviate from their planned trajectory. The deviation is measured at intervals with down-the-hole devices, none of which are precise. For deep drilling, the rig is equipped to re-align the drill string and keep it on line.

In the past, it was considered good practice to fill the empty borehole with cement grout when completed. Today, this procedure is delayed because an open hole (even if it encountered no mineralization) is valuable for the purpose of cross-hole tomography, etc. that may indicate an ore zone missed by the drilling pattern.

1.5 Ore Reserves

General

Historically, mineral properties were simply classified into three reserve categories: *Proven, Probable and Possible*. In 1980, the USBM and USGS jointly introduced an expanded system that separated the geological analysis (resource determination) from the subsequent mineable analysis (reserve determination). In 1989, the AIMM of Australia expanded definitions and introduced the concept that a reserve analysis should be carried out under the direction of and certified by an “expert,” who is a qualified professional. Since that time, more work has been accomplished to further refine the classification system. Most recently, the Canadian government published “*Standards for Disclosure*” (*National Instrument 43-101*) that provides further interpretation. Unfortunately, there is not yet an international standard that defines the terms used, let alone a common code for the determination of the separate categories of certainty. The good news is that an effort is underway to set international standards that will satisfy the securities commissions of the stock exchanges that provide the great majority of equity financing for the world’s mining industry (Johannesburg, London, New York, Sydney, and Toronto). These new standards are more restrictive (more conservative) than the traditional standards.

In the mean time, major mining companies (who often finance new projects internally without resorting to the equity markets) developed their own systems. These are generally similar to the mainstream standards. One significant exception is that normally a qualified *team* of professionals is responsible for determining and certifying ore reserves rather than an individual “Expert,” “Accredited Senior Appraiser,” or “Qualified Person.” The professional team concept appears wiser than the individual concept promoted by the published guidelines and standards, since few, if any, individuals are expert in four disciplines (geological interpretation, statistical analysis, mining methods, and mineral economics).

Definitions

The following are unofficial definitions intended to meet the expectations of a handbook. They are generally representative of current industry standards.

A discovered mineralization zone will undergo three phases of identification before it is ready for mining.

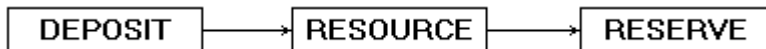

A *Deposit* is a mineralized zone that is examined to the extent that the mineral constituents are identified. The examination may reveal some geological continuity and approximate grade (tenor), but there is insufficient information to class it as a *Resource*.

A *Resource* is a mineralized zone that is sampled and studied to the extent that a credible estimate of tonnage and grade can be made. This estimate is sufficiently definitive to divide it into three levels of certainty: Measured, Indicated, and Inferred.

A *Measured Resource* is the highest order and implies that the measurements are made in three dimensions at intervals close enough to be used as a basis for detailed mine planning, as would be the case for stope development in an operating mine. In the instance of a new project being contemplated, it is typical that there will be little or no measured resources.

An *Indicated Resource* is one that the estimate of tonnage and grade is trustworthy to the extent that it may serve as a basis for major expenditures.

An *Inferred Resource* is a potential resource that is assumed to exist, by reason of logical extrapolation or interpolation.

A *Reserve* is the portion of a mineral resource that may be extracted at a profit. While a resource is based upon geological interpretation, a reserve has been analyzed further to take actual mining into account. A more precise definition is, “*That part of a mineral resource that has been analytically demonstrated to justify mining, taking into account, at the time of determination, mining, metallurgical, marketing, legal, environmental, social, economic and other applicable conditions.*” (Extracted from the Johannesburg Stock Exchange listing requirements: Mineral Companies, Chapter 12.)

A *Reserve* may be divided into two categories of certainty: Proven and Probable.

Table 1-2 Categories of Certainty

Category	Mineral Resource	Mineral Reserve	
1	Measured	Proven	2P
2	Indicated	Probable	(Proven + Probable)
3	Inferred		

A *Proven Reserve* is derived only from a measured resource. This category is generally limited to a mining zone being mined or one that is already prepared for mining, to include preproduction stope development. Typically, for most new mining projects, there will be little or no proven reserves.

A *Probable Reserve* is that part of an Indicated Resource subjected to the scrutiny required of a Detailed Feasibility Study (refer to Chapter 6) and thereby may be found to justify the expenditure required for mining. In a formal economic analysis, only probable and proven reserves are employed. The sum of these two categories may be referred to as "2P."

A *Possible Reserve* is an obsolete category since by current standards it may not be used in any formal economic analysis. When reporting on a mineral property, a potential or possible zone of mineralization best remains identified as an *Inferred Resource*. For purposes of a preliminary study, a "possible reserve" may be calculated to perform an analysis only when desired to justify additional exploration work.

1.6 Evaluating Exploration Properties

Properties with fully developed ore reserves are evaluated for potential as a profitable mining enterprise by formal procedures. (Refer to Chapter 6, Feasibility Studies, and 7, Mineral Economics.)

Frequently, properties are required to be evaluated (for sale, joint ventures, or other transactions) with only drill indicated or inferred reserves. In many cases, the value depends only upon exploration data that is favorable to an anticipated discovery based on hypothetical interpretation of geology. Sometimes, untouched exploration properties are valuable simply because they occur in a fashionable area, such as near a recent spectacular discovery.

If exploration expenditures are incurred on the property, expenses not resulting in condemnation enhance property value. If no indication of mineral resource is identified and the property is idle, the value must be limited to no more than half of the spent costs. When results are positive, exploration is ongoing, and work to date has been completed with diligence and efficiency, 100% of the funds already expended can be added to the property value.

A different approach was originally developed to assist with properties submitted for approval by the Toronto Stock Exchange. The method assumes that a property is first acquired by staking claims, the cost of which is known. The first cost is multiplied by weighed factors for items of value (such as regional geology, proximity to infrastructure, geological data quality, executive integrity, or field manager reputation) to obtain valuation.

Other approaches exist to evaluate mineral properties, including so many dollars per ounce of "gold in the ground," but these methods are no longer popular.

Liabilities must be subtracted from the positive values of an exploration property. For example, the purchaser or partner may become responsible for the cost of clean up and restoration if the property is later abandoned. Liabilities are not normally significant for a green field play, but if the property is environmentally sensitive; subject to native land claims; or contains old dumps, tailings, or mine workings, it is prudent to assess the liabilities.

1.7 Estimating Ore Reserves

Estimation includes determining tons, grade, and degree of certainty (proven or probable).

Tons

Resource tonnage is obtained by multiplying ore volume by its density. For example, 1,000 cubic meters of ore with an SG of 3.0 weighs 3,000 metric tons (tonnes). The volume is computed from ore outlines and the SG determined by weighing a sample in air and suspended in water. The calculation of volume is not complicated and may be determined with confidence, provided the ore outlines are accurate. Unfortunately, less attention is given to the accuracy of specific gravity. Sources of the figure(s) provided should be questioned.

A wrong value is obtained from slurry analysis carried out in a metallurgical testing laboratory. The reason is that ore is porous and when finely ground; the density of individual particles is approximately 20% higher than the density of a block of ore.

In a *Reserve* calculation, resource tons are "reduced" to account for the fact that not all the ore will be mined. Conversely, resource tons are "increased" to account for dilution with waste rock in a contact orebody or with low-grade material in a cut-off orebody. Nineteen different contributing factors are considered in a comprehensive estimate of the amount of dilution (refer to Chapter 3 – Mining Methods.)

Grade

Proper grade determination for an orebody is difficult and time consuming.

“The arithmetic mean is a very inadequate axiom. Instead of adding up a series of observations and then dividing the sum by the total number of observations, equal suppositions would have equal consideration if the estimates were multiplied together instead of added. Mother Nature is not troubled by difficulties of analysis, nor should we.”

Lord Keynes

Elementary components (observations) consist of orebody sample grades and location. In hard rock formations, these typically consist of assay results from diamond drill cuttings (sludge), split drill core, and channel samples. Sometimes these are augmented by bulk sample assays or cuttings from inclined percussion drilling into the walls of exploration headings. For the sample assay grade to be correct, they must be collected properly and protected from contamination (or salting) in transit. Except for a major mining company with in-house expertise, a recognized independent laboratory should perform the assays. The best-recognized laboratory available should be selected to perform periodic check assays. For foreign projects, all assays, or at least check assays, should be performed domestically.

Note

Problems may arise when shipping sample bags to the home country unless they are double tagged (one may be torn off by baggage handlers) and clearly labeled, “Pure mineral rock samples” to avoid detainment in customs.

Once samples are taken, ore reserves are divided into blocks of convenient size. A grade for each block is determined from samples in and near the block. Each sample assay used for the block grade determination is assigned a weight. The sum of the weights is one (or 100%). Weights are dependent on the degree of variation between the samples employed; grade resolution is determined by the application of statistical analysis to the variations. A geostatistical tool, “Variogram,” is typically used to represent the variance of samples with respect to the distance separating them. The block grade is determined by summing the products obtained from multiplying each sample grade by its assigned weight.

Blocks not meeting the cut-off grade are removed from the reserve ton calculation. The cut-off grade is traditionally the breakeven point (neither profit nor loss). Recently, cut-off grade is chosen to ensure a low cost product compared with the cost incurred at competing mines around the world. When the mine is in production, the cut-off grade may be lowered after the pre-production capital cost is retired. Cut-off grade may be raised or lowered at any time during mine life depending on prevailing metal prices.

1.8 Underground Exploration Entries

The nature and circumstance of the typical hard rock ore deposit is such that the exploration program may not properly be completed without including exploration work from an underground entry. This concerns open pit projects where a representative bulk sample is required (Twin Buttes, Tyrone, Brenda, Endako, Marcopper, Palabora, Escondida); and especially pertains to underground deposits. Numerous instances have occurred where underground mines developed without such a program, encountered significant problems due to unforeseen circumstances.

Those mines successfully brought into production without an exploration entry typically involved ore bodies clearly defined from surface drilling because of the nature of the mineralization and/or the proximity of very similar deposits already mined. Even these circumstances are not foolproof. For example, the Randfontein mine (where the ore is exceptionally uniform and continuous) encountered an unexpected barren area that interrupted the ore throughout a horizontal length of over 8,000 feet along the reef.

Industry standards and good engineering practice normally require that a hard rock mining project begin with an underground exploration program before proceeding with a definitive (bankable) feasibility study.

Below ground only can the miner ‘shake hands with the ore.’

Arnold Hoffman, 1947

Listed below are the specific reasons for completing an underground exploration program.

- Confirm existing ore reserves
- Define the orebody
- Obtain geotechnical data
- Obtain a bulk sample
- Test mining methods
- Measure ground water flows
- Further exploration

Confirm Existing Ore Reserves

Surface drilling permits measurement of the ore reserves from only two dimensions. Hence, none of the underground mineral deposit can be officially classified as "proven." Three-dimensional measurement may be only undertaken from underground to confirm continuity of ore outlines between drill holes.

"When it comes to measuring ore reserves accurately, the key is a proper mix of sampling theory (statistics) and geology. Geostatistical methods depend heavily on large sample numbers and extensive close-spaced sampling, including heavily drilling local areas to estimate mining selectivity. Extensive drilling may not be economical in a small orebody. Even in a large orebody, going underground may ultimately be the only way to determine how well the ore can be followed."

Gary Raymond, Canadian Mining Journal, August, 1985

Define the Orebody

Most surface drilling requires substantial distance to reach the underground ore deposits. The distance and length of drill string required can result in considerable hole deviation. The deviations can be determined and considered, but the measurement is not always accurate. Inaccuracy can result in a distorted interpretation (whether by computer or manual means) of the actual ore configurations, outlines, continuity, fault lines, and grade distribution.

For mining engineers to select the appropriate mining methods to permit the safe and economical extraction of the largest possible percentage of identified reserves, reliable and definitive information on grades and widths is required. This requirement can only be met by going underground.

Obtain Geotechnical Data

Ordinarily, geotechnical/rock mechanics data can be obtained from the drill core and logs gathered during surface drilling; however, early drilling is often completed to identify ore and mineralization grades to confirm the general project direction and/or "sell" the project. Typically, little or no consideration is given to geotechnical properties, some of which can only be measured accurately from freshly extracted core. Core that could provide geotechnical data often is consumed for assay and bench testing purposes or is kept for verification purposes.

Some required geotechnical information (measuring the direction and magnitude of the ground stress regime) can only be completed underground. An underground exploration development program should provide reliable values for ground stress as well as unconfined compressive strength (UCS), modulus of elasticity (E), SG, work index (Wi), internal angle of friction (ϕ), and bulk density of the broken ore.

Together with values for rock quality designation (RQD), joint indices (J), and stress reduction factor (SRF) obtained from proper drill core logs, this data describes the engineering properties of rocks to be developed, supported, built against, and mined. The resulting array of geotechnical criteria is essential for sound underground mine design.

Obtain a Bulk Sample

For proper metallurgical testing, large sized samples are required (much larger than can be obtained from drill core). Only from underground can representative ore samples be obtained in the quantities required. Bulk samples are especially important when bench testing (on drill core) indicates a complex metallurgy requiring significant testing and analysis to obtain a high percentage of mineral recovery in the process plants (i.e. mill, smelter, and refinery).

In addition, bulk sampling enables advance determination of whether preventive measures are desired to reduce detrimental oxidation of wall rock and/or broken ore resulting from an undesirable mineral component such as pyrrhotite. The bulk sample will also enable further confirmation of ore distribution and grades.

Test Mining Methods

Conventional practice requires excavating test stopes underground to obtain the bulk samples described above. Examining these larger sized openings is valuable in evaluating mining methods for the orebody. Ground reinforcement required to maintain the structural integrity of the excavations (rock bolts, screen, etc.) can be monitored for long-term stability. The results may be later applied to establish safe ground support criteria and standards for underground operations.

Measure Ground Water Flows

The methods used to predict water inflows underground from surface drill holes (packer tests) are inadequate for the accurate measurements required to determine the underground pumping and dewatering requirements of a hard rock mine. Only by going underground can the requirements for grouting and dewatering be reliably determined in advance.

Further Exploration

An underground exploration program is typically designed to uncover additional ore extensions and satellite zones of mineralization that may have been missed by surface drilling.

1.9 Mine Entry Comparisons

The following paragraphs compare early mine entries for underground exploration. For hard rock mines, different suitable entry types exist, each representing a substantial effort and expenditure. The type and location of an exploration entry must be selected with diligence to ensure the entry will not interfere with future development, and to determine potential value as a permanent facility for subsequent development and operation.

Exploration entry design requires consideration of the permanent production facility (Conceptual Mine Plan), particularly with respect to material and personnel handling as well as the permanent ventilation circuit.

Listed below are the entry types used for underground exploration.

- Vertical Shaft
 - Rectangular timber two compartment
 - Rectangular timber three compartment
 - Circular concrete lined (monolithic)
 - Circular concrete lined (concrete rings)
 - Circular bald
 - Drilled shaft
- Inclined Shaft
- Trackless Entry
 - Ramp Access [suitable for load-haul dump (LHD) equipment access]
 - Decline Access (suitable for a belt conveyor installation)
 - Adit Access (suitable for either – in mountainous or foothill regions of high relief)
- Double Entry

Vertical Shaft – Rectangular Timber Two Compartment

The rectangular timber two-compartment shaft is suitable for remote locations because the sinking plant is relatively small and the components are typically provided in portable modular or pre-fabricated units. The disadvantage is that these shafts are not suitable for depths greater than approximately 400m and they do not have the hoisting capacity required for subsequent development of a large underground mine. The sinking hoist is small and hoists only a single line in one of the two compartments (the other is required for the manway, vent duct, and service lines).

Vertical Shaft – Rectangular Timber Three Compartment

The rectangular timber three-compartment shaft is the most common type of entry employed for an underground exploration program. Although more expensive, the shaft can be sunk to great depths and have a much higher hoisting capacity due to the larger plant and ability to hoist with two skips in balance. When the exploration and mine development is completed, this shaft can be used as second egress from underground or stripped of its timber (and slashed, if necessary) to provide a permanent ventilation entry.

The three-compartment shaft is the conventional choice for an initial entry. In some applications, timber sets have been replaced with steel. Steel is lighter to transport but less adaptable for installing catch pits and water rings. Steel sets are not recommended unless the sets must be shipped to the site by air. This type of shaft could be suitable for an ore deposit requiring extensive lateral development in the exploration phase and is too deep for ramp haulage during the subsequent pre-production development phase.

Vertical Shaft – Circular Concrete Lined (Monolithic)

The circular concrete lined (monolithic) shaft is not commonly employed as an exploration entry unless the anticipated ground conditions are poor or the shaft is very deep. Advantages include shaft sinking at a faster rate than timber shafts, a high hoisting capacity, and future service as a major entry for the permanent mine with little or no modification. A disadvantage is that these shafts are expensive and slow to set up for sinking. Another problem is that the exact diameter to fit the permanent mine entry must be determined in advance, which can be difficult or impossible. A specific disadvantage at a remote location is the requirement for significant quantities of concrete. This can be difficult and expensive during the early project stages.

Vertical Shaft – Circular Concrete Lined (Concrete Rings)

The circular concrete lined shaft with concrete rings employs a segmented concrete lining. Horizontal segments or “rings” approximately 1.5m in height are poured against the wall of the excavation at approximately 5m centers. The open ground between the rings is permanently secured with rock bolts and screen. Concrete ring shafts can be less expensive than monolithic concrete lined shafts. One disadvantage is slow sinking compared to the monolithically designed shaft. Another is the concrete rings becoming a problem (high resistance factor) if the shaft is subsequently employed as a high velocity ventilation airway.

Vertical Shaft – Circular Bald

Instead of using concrete, the circular bald shaft walls are secured entirely with rock bolts and screen as the shaft advances. While relatively inexpensive compared to concrete, it is generally considered less safe to sink. While often employed in developing countries, circular bald shafts are rarely found in North America. One sunk a few years ago in Northern Manitoba is reported to have developed problems since completion. Some of the difficulties with this type of shaft include the lack of catch pits, challenge in installing water rings, and difficulty in placing working platforms in the shaft. Circular bald shafts typically employ rope guides and thus have no sets.

Vertical Shaft – Drilled

The drilled shaft is typically the most expensive and is normally employed only where the shaft must advance through a horizon of very poor and/or heavily water bearing ground. These shafts are often advanced very quickly but only after a prolonged set-up period. An apparent exception is shafts that were drilled in “good” ground in Australia.

Inclined Shaft

The inclined shaft is rarely used except to access undersea deposits. A number are operating in Cape Breton, Nova Scotia. Disadvantages include the relatively slow rate of advance and limited hoisting capacity for subsequent operations. For example, four inclined shafts were required to hoist the iron ore on Belle Island, NFLD.

Trackless Entry Ramp Access

Ramp access is the usual choice for shallow ore bodies, particularly when the ore is flatly dipping. Even if the underground deposit is steeply dipping, permanent ramp access from surface is desirable for an operating mine. Providing a ramp cross-section large enough to accommodate truck haulage should be considered. If not, at least the portal should be built oversize. Since the ramp is flexible with respect to alignment, the portal can be located where the overburden is shallow or a surface outcrop is encountered.

Trackless Entry Decline Access

The decline access is similar to the ramp access except that it must be driven straight to accommodate a belt conveyor.

For a very large orebody, it is often the case that the only practical alternative to a permanent conveyorway is vertical shaft hoisting. Ore is normally conveyed on surface from a shaft to the mill (if a considerable distance). Therefore, it is practical and logical to drive the first leg of a conveyorway toward a potential shaft location because it permits an underground dump in the shaft. If the shaft option is later selected over a conveyorway, the skips can dump underground instead of on surface. Ore can be conveyed directly from the underground dump to the mill by the top leg of (what would have been) a full conveyor system. Advantages include providing a route for alternate egress, LHD entry, a lower headframe, and less real estate on surface (no overland conveyorway). This procedure is employed at the Shebandowan and Dome mines in Ontario, Canada.

The trackless entry decline is a practical alternative if the portal location lies in shallow overburden and the production shaft location can be determined in advance.

Trackless Entry Adit Access

Adit access is advantageous in high-relief terrain. Similar to a ramp or decline, if driven beneath the orebody, it can serve as a future haulage way or drainage tunnel.

Double Entry

A single entry will not provide the ventilation later required to support the rapid advance of pre-production development excavation for a major underground orebody. Proper ventilation must be provided by a second entry. One option is to advance simultaneously two separate entries into the ore deposit at the exploration phase.

The main advantage of this option is the time it will save in the subsequent pre-production phase. It also provides second egress (escape route) at an early stage. If either entry is slowed by unforeseen events (encountering water or adverse ground), the exploration schedule will not be compromised. Implementing this approach at the exploration stage provides a head start to production with a high degree of reliability.

1.10 Tables

Listed below are tables appended to this chapter.

- Geologic Time Table (Abbreviated)
- Mineral Hardness
- Rock Hardness (Typical Values)

Geologic Time Table (Abbreviated)

Table 1-3 shows chronological, top-down geologic time.

Table 1-3 Geologic Time

Era	System	Duration 10 ⁶ a	Duration cum x 10 ⁶ a
CENOZOIC	Quaternary	1	1
	Tertiary	63	64
MESOZOIC	Cretaceous	62	126
	Jurassic	46	172
	Triassic	49	221
PALEOZOIC	Permian	50	271
	Pennsylvanian	30	301
	Mississippian	35	336
	Devonian	60	396
	Silurian	20	416
	Ordovician	75	491
	Cambrian	100	591
	PRECAMBRIAN		3,000,000+

Mineral Hardness

Table 1-4 shows Mohs' Scale for mineral hardness.

Table 1-4 Mohs' Scale for Mineral Hardness

Hardness Value	Mineral	Hardness Value	Mineral
1	Talc	7.5	Zircon
2	Gypsum	8	Topaz
3	Calcite	8.5	Chrysoberyl
4	Fluorite	9	Sapphire
5	Apatite	9.5	Carborundum
6	Orthoclase	10	Diamond
7	Quartz		

To test a new specimen, a smooth surface is selected, and rubbed with a tool or standard specimen. A fingernail will scratch to a hardness of 2 ½, copper penny 3, and penknife 5 ½. In general, a scratch will appear when a standard mineral of equal or greater hardness is used.

Rock Hardness

The following table shows Mohs' Scale for rock hardness.

Table 1-5 Mohs' Scale for Rock Hardness

Hardness Value	Rock	Hardness Value	Rock
3.0	Limestone	6.0	Trap rock
3.5	Dolomite	6.5	Chert
4.0	Granite	7.0	Quartzite

2.0 Rock Mechanics

2.1 Introduction

Chapter 2 is primarily concerned with underground mining. The application of rock mechanics to open pits (slope stability) is not pursued.

“Mining is defined as the art of working mines and a mine is defined as an excavation out of which minerals are dug. The latter definition is not complete. Implicit in the word mine is the need to insure that the mine excavation (or excavation cavity) is safe to work in.”

“The miner wants to plan development and mining so that the adverse effects of rock failure will be minimized. This is the place for rock mechanics, the science that studies the strength and failure characteristics of rocks.”

“The early approach to rock mechanics was to treat rock as an elastic body, not unlike the way civil engineers treat concrete. The elementary concept is that a unit of rock underground is stressed by the weight of rock above it and constrained by other rock around it, thus inducing a horizontal stress, which is a function of Poisson’s ratio.”

“The subsequent study of rock masses and the effects of geology has produced more realistic concepts to which the irregular geometry of an orebody gives challenge.”

Alex Ignatieff 1970

“Routine rock mechanics may be used to design temporary and permanent ground support designs in elastic or quasi-elastic ground (i.e. hard rock). Nevertheless, such systems fail as the condition of the rock mass approaches the Yield State in which condition plastic or viscous response components become dominant – and any design based on or extrapolated from elastic behavior is void.”

John D. Morton 1990

That rock is elastic can be demonstrated by bending a long length of drill core – it will bend and (provided you don’t break it) will spring back to its original position. Because of this elastic behavior, we can (as a first approximation) determine the stresses and strains around a mining excavation using the theory of elasticity; however, the properties of hard rocks are greatly altered by the inevitable presence of joints, laminations, geological contacts and other discontinuities. Although the individual solid blocks of rock can have considerable strength, the presence of the discontinuities reduces the strength of the overall rockmass. This reduction of strength and elastic properties must be accounted for in carrying out numerical modeling of a real mining geometry.

The situation is often further complicated by the fact that the integrity of a typical underground hard rock mine and the facility to safely mine within it, may rely on a structural (cemented) backfill which may not always behave elastically. Dynamic behavior is also possible, since deep hard rock mines (and even some that are shallow) can experience rockbursts caused by elastic instability. In spite of all these complications, three-dimensional numerical modeling has advanced to the stage where the elastic and post-failure inelastic behavior of the rock and ore in a typical deep hard rock mine can be modeled with a reasonable degree of confidence.

2.2 Rules of Thumb

Ground Stress

- The vertical stress may be calculated on the basis of depth of overburden with an accuracy of $\pm 20\%$. This is sufficient for engineering purposes. *Source: Z.T. Bieniawski*
- Discs occur in the core of diamond drill holes when the radial ground stresses are in excess of half the compressive rock strength. *Source: Obert and Stephenson*
- The width of the zone of relaxed stress around a circular shaft that is sunk by a drill and blast method is approximately equal to one-third the radius of the shaft excavation. *Source: J. F. Abel*

Ground Control

- The length of a rock bolt should be one-half to one-third the heading width. *Mont Blanc Tunnel Rule (c.1965)*
 - In hard rock mining, the ratio of bolt length to pattern spacing is normally $1\frac{1}{2}:1$. In fractured rock, it should be at least $2:1$. (In civil tunnels and coalmines, it is typically $2:1$.) *Source: Lang and Bischoff (1982)*
-

Ground Control (continued)

- In mining, the bolt length/bolt spacing ratio is acceptable between 1.2:1 and 1.5:1. *Source:* Z.T. Bieniawski (1992)
- In good ground, the length of a roof bolt can be one-third of the span. The length of a wall bolt can be one-fifth of the wall height. The pattern spacing may be obtained by dividing the rock bolt length by one and one-half. *Source:* Mike Gray (1999)
- The tension developed in a mechanical rock bolt is increased by approximately 40 Lbs. for each one foot-Lb. increment of torque applied to it. *Source:* Lewis and Clarke
- A mechanical rock bolt installed at 30 degrees off the perpendicular may provide only 25% of the tension produced by a bolt equally torqued that is perpendicular to the rock face, unless a spherical washer is employed. *Source:* MAPAO
- For each foot of friction bolt (split-set) installed, there is 1 ton of anchorage. *Source:* MAPAO
- The shear strength (dowel strength) of a rock bolt may be assumed equal to one-half its tensile strength. *Source:* P. M. Dight
- The thickness of the beam (zone of uniform compression) in the back of a bolted heading is approximately equal to the rock bolt length minus the spacing between them. *Source:* T.A. Lang
- Holes drilled for resin bolts should be ¼ inch larger in diameter than the bolt. If it is increased to 3/8 inch, the pull out load is not affected but the stiffness of the bolt/resin assembly is lowered by more than 80%, besides wasting money on unnecessary resin. *Source:* Dr. Pierre Choquette
- Holes drilled for cement-grouted bolts should be ½ to 1 inch larger in diameter than the bolt. The larger gap is especially desired in weak ground to increase the bonding area. *Source:* Dr. Pierre Choquette
- Every 100° F rise in temperature decreases the set time of shotcrete by 1/3. *Source:* Baz-Dresch and Sherril

Mine Development

- Permanent underground excavations should be designed to be in a state of compression. A minimum safety factor (SF) of 2 is generally recommended for them. *Source:* Obert and Duval
- The required height of a rock pentice to be used for shaft deepening is equal to the shaft width or diameter plus an allowance of five feet. *Source:* Jim Redpath

Stope Pillar Design

- A minimum SF of between 1.2 and 1.5 is typically employed for the design of rigid stope pillars in hard rock mines. *Various Sources*
- For purposes of pillar design in hard rock, the uniaxial compressive strength obtained from core samples should be reduced by 20-25% to obtain a true value underground. The reduced value should be used when calculating pillar strength from formulae relating it to compressive strength, pillar height, and width (i.e. Obert Duval and Hedley formulae). *Source:* C. L. de Jongh
- The compressive strength of a stope pillar is increased when later firmly confined by backfill because a triaxial condition is created in which σ_3 is increased 4 to 5 times (by Mohr's strength theory). *Source:* Donald Coates

Subsidence

- In Block Caving mines, it is typical that the cave is vertical until sloughing is initiated after which the angle of draw may approach 70 degrees from the horizontal, particularly at the end of a block. *Source:* Fleshman and Dale
- Preliminary design of a block cave mine should assume a potential subsidence zone of 45-degrees from bottom of the lowest mining level. Although it is unlikely that actual subsidence will extend to this limit, there is a high probability that tension cracking will result in damage to underground structures (such as a shaft) developed within this zone. *Source:* Scott McIntosh
- In hard rock mines employing backfill, any subsidence that may occur is always vertical and nothing will promote side sloughing of the cave (even drill and blast). *Source:* Jack de la Vergne

Rockbursts

- 75% of rockbursts occur within 45 minutes after blasting (but see below). *Source:* Swanson and Sines
 - The larger the rockburst, the more random the pattern in time of occurrence. Microseismic data from many areas shows that the smaller microseismic events tend to be concentrated at or just after blast time, on average (see above). However, the larger the event, the more random its time of occurrence. *Source:* Richard Brummer
 - In burst prone ground, top sills are advanced simultaneously in a chevron ('V') pattern. Outboard sills are advanced in the stress shadow of the leading sill with a lag distance of 24 feet. *Source:* Luc Beauchamp
 - Seismic events may be the result of the reactivation of old faults by a new stress regime. By Mohr-Coulomb analysis, faults dipping at 30 degrees are the most susceptible; near vertical faults are the safest. *Source:* Asmis and Lee
 - There can be little doubt that it is possible to control violent rock behavior by means of preconditioning or de-stressing under appropriate circumstances. This technology, therefore, has the potential to be profitably harnessed for use in the mining of deeper orebodies, particularly hazardous situations such as highly stressed high grade remnants, or development into areas known to be prone to bursting. *Source:* Board, Blake & Brummer
-

2.3 Tricks of the Trade

- For development openings (drifts cross cuts, pump stations, etc.), excessive stress concentrations are to be avoided. Hence, brows should be arched to the shape they would otherwise tend to work to. *Source:* Coates and Dickhout
- When discs occur in the core of diamond drill holes, the thinner the discs, the higher the ground stress. *Source:* Allan Moss
- Where discing occurs in diamond drill core, there should be no RQD penalty. Discing is a stress phenomenon unrelated to rock fabric. *Source:* Phil Oliver
- Caution should prevail when proposing a central rib pillar to provide integral support for a stoping area. The rib pillar may provide a home for wayward stresses and cause serious problems. *Source:* Fritz Prugger
- In hard rock mines, the most effective ground support systems are those that are installed as soon as possible after excavation of the opening. *Source:* Kevin Cassidy
- The application of empirical rules requires rounding to obtain a standard length and pattern for rock bolts. If the calculated length is rounded up to the nearest standard length, the calculated spacing should also be rounded up to a standard pattern, and vice-versa. *Source:* Mike Gray
- It is extremely difficult to fully spin-in an eight-foot (2.4m) resin rock bolt with a jackleg or stoper drill. Where a jumbo drill cannot be employed, consideration should be given to specifying shorter bolts on a tighter pattern. *Source:* Doug McWhirter
- At intersections of wide headings and wide back man-entry stopes, long cable bolts on a wide pattern support the span while shorter rock bolts installed between them prevent raveling and wedge development. The empirical rules used for length and pattern of rock bolts may also be applied to the cable bolts. *Source:* Mike Gray
- In heavy ground, a proposed T intersection should be replaced where practical with a Y configuration. If the legs of the Y are oriented at 120 degrees, the span of open ground is minimized, and the tendency for the sharp corners to deteriorate is reduced. *Source:* Richard Brummer
- In slabby ground, straps may be a more effective support than screen. These straps should be placed between rock bolts and run across the layering. Straps placed parallel to the plane of weakness are generally a waste of money. *Source:* Hoek and Wood
- The long axis of a rectangular shaft should be oriented perpendicular (normal) to the strike of the orebody. *Source:* Ron Hafidson
- The long axis of a vertical rectangular shaft should be oriented perpendicular (normal) to the bedding planes or pronounced schistosity, if they are near vertical. *Source:* R. K G. Morrison
- The long axis of a rectangular shaft should be oriented normal to regional tectonic stress and/or rock foliation. *Source:* Jack Morris

- The long axis of underground openings should be oriented parallel to the maximum horizontal stress. This minimizes the amount of disturbance of the stress field compared to an opening normal to the maximum stress. *Source: David Plumeau*
- When designing a large opening underground it may be better to have it wider than longer, i.e. equi-dimensional, because (theoretically) the compressive ring stress around a spherical opening (in an elastic medium) is only three-quarters that around a cylindrical opening. *Source: Jack Spalding*
- Reinforcing steel applied to draw points in a Block Caving operation has been found to be a detriment rather than help. Failure results sooner than with plain concrete. The reason is believed to be that percussion caused by secondary blasting causes resonance within the reinforcement that tends to spring it free from the concrete. The stress concentrations encountered are mainly compressive and steel is not an economical material to withstand compression. *Source: Hannifan and Hill*
- The fundamental distinction between underground mining methods is between those that employ pillars in ore and those that seek complete extraction in the first pass. In burst-prone ground the latter is essential to reduce the incidence of rockbursts. *Source: RKG Morrison*
- In deep mines, the aim of all stope planning should be complete recovery. *Source: Jack Spalding*
- The first goal of research and development is surely to achieve success in the prevention of rockbursts, not their prediction. *Source: A. van Z. Brink*
- In burst-prone stopes, it can take up to five hours to reach stress equilibrium after a blast. For these conditions, stoping is carried out on a single shift basis. *Source: E.L. Corp.*
- In burst-prone ground, if failure of a rib pillar occurs in the first or second cut, it can be violent, whereas if it occurs after the third cut it is generally a gentle, yielding-type failure. *Source: Singh and Hedley*
- When sinking a shaft full-face, the best way to reduce bottom heave in burst-prone ground is to approach the ideal hemispherical shape by making the bottom dish-shaped. Once the required shape is initiated, it is easily preserved in subsequent rounds. *Source: Jack Spalding*
- Inclusions, such as dykes or sills are typically more brittle (stiffer) than the country rock. They attract stress and, as has been well documented, can be the source of more and bigger rockbursts. Conversely, a soft formation or fault sheds its stress and driving a heading or mining towards it can cause the face to suddenly explode. *Source: Coates and Dickhout*
- When it is required to drive a lateral heading to a completed shaft or crusher room, it is preferable to start driving from the shaft or room towards the advancing drift rather than hole the drift directly into it. In this manner, the safest intersection of all is made – the straight line holing. In bad ground, both headings should have extra ground support as the intersection is approached. *Source: Jack Spalding*
- When new loose soon develops on ground that was previously scaled to solid, it is a sign of high stress and an omen for rock bursts. *Source: Merv Dickhout*
- In burst-prone ground, big loose should be blasted down. The loose may be restraining rock behind that is already strained to the limit and will burst. Really big loose found anywhere in a mine should be either pinned in place or blasted down, not scaled or barred down. *Source: Bob Dengler*
- To help avoid rockbursts, headings and faces should be advanced continuously and the ventilation and air temperature should be kept constant, even during shutdowns necessary for holidays, etc. *Source: Jack Spalding*

2.4 The Role of Rock Mechanics

“In this case (Thames Tunnel), an excavation method to suit the ground conditions is what is required. Altering the ground to satisfy a method is not practical here.”

Sir Marc Brunel 1830

A conflict remains between a “traditional” or “reactive” and a “progressive” or “proactive” concept of rock mechanics. The traditional concept says that rock mechanics should facilitate practiced mining procedures (i.e. be reactive). The progressive concept says rock mechanics should guide determination of all the procedures in the first place (i.e. be proactive).

Based on the traditional (fragmented) concept, the role of rock mechanics may be categorized as follows.

- Location, support, and protective pillars for mine entries such as shafts.
- Dimension, support, and geometry of mine development headings.
- Size, pattern, and orientation of stopes and stope pillars.
- Sequence and timing of extraction.
- Prediction of backfill performance.
- Procedures at mine closure.

The subsequent contents of this chapter are intended to facilitate a proactive approach. For this purpose, rock mechanics is discussed under the following headings.

- Rock Stress (Section 2.5)
- Ground Control (Section 2.6)
- Stability of Excavations (Section 2.7)
- Rockbursts (Section 2.8)

(Backfill is dealt with separately in Chapter 21.)

2.5 Rock Stress

A force field that is applied to a liquid or gas is called a *pressure*; if applied to a solid it is termed a *state of stress*. The pressure at a point in a liquid or gas is always equal or uniform in each direction (i.e. it is *hydrostatic*), but the stress will in general vary, depending on the direction. The stress state at a point in a rock mass is a *tensor* quantity – the magnitude of the stress and the nature of the stress depends on the direction of interest.

It is important to distinguish between virgin stress (existing before mining), the induced stress (the stress change induced in the rock by the action of mining), and the field stress or total stress (the sum of the virgin and the induced stress fields).

2.5.1 Virgin (in situ) Ground Stress

The natural stress that exists in a rock mass before it is subjected to mining is referred to as a “virgin,” “primitive,” or “in situ” stress. For purposes of analysis, the vertical and horizontal components are considered separately. The vertical stress component is simply calculated by elastic analysis for any particular depth of proposed mining, while the horizontal stress is not.

Vertical Stress

In the hard rocks of the world, the vertical stress is typically a straight-line function of the weight of the column of rock lying above the depth in question. The following formula is true for typical quartz and feldspar rich hard rocks with a SG of 2.65.

$$\begin{aligned} \text{Average vertical stress gradient} &= 2.65/102 = 0.0260 \text{ MPa/m of depth, or} \\ &= 2.65 \times 62.44/144 = 1.15 \text{ psi/foot of depth} \end{aligned}$$

Source: Dr. G. Herget

In rock mechanics literature, this vertical stress may be referred to as the “gravitational stress,” “lithological stress,” or “overburden stress.”

Horizontal Stress

Determining the natural horizontal stress is more difficult. In North America, the horizontal stress is usually larger than predicted by simple elastic analysis, and it is not equal in each direction. Furthermore, horizontal stress is site specific. Generally, it is considered that the horizontal stress is a maximum in one direction and decreases to a minimum in the direction orientated at 90 degrees. The maximum is referred to in the literature as the “principal” or “major” stress (σ_1), and its orientation as the “major axis.” The minimum, normal (90 degrees) to the maximum, is typically referred to as the “intermediate” stress, (σ_2), since in North America the “minor” stress, (σ_3) is usually vertical.

Residual Stress

The intensity and orientation of virgin stress may be significantly altered when the mine is situated near a major fault line in the earth’s crust. An example is the former Lucky Friday Mine in Idaho located near the Osburn Fault, which is reported to have a displacement (slip) of 15 miles. This type of virgin stress is classed as one sort of tectonic stress. If the cause of a tectonic stress is later relieved by force of nature, a portion of the stress remains in the rock and is referred to as residual stress.

Industry Notes

The following notes (accredited to experts) are selected and arranged in a sequence designed facilitate understanding of the horizontal stress phenomenon. The notes start with general observations, then discuss a large regional district (Canadian Shield), and finally refer to a specific mining location within the district.

- By elastic theory, the horizontal stress ought to be near one-third the vertical stress. In fact, it is always much higher than this. In the absence of in situ stress measurements or other indications of a higher horizontal stress, the most reasonable assumption (for open pit slope analysis) is that the horizontal stress is equal to the vertical stress. *Source: Richard Call*
- High horizontal stresses are a worldwide phenomenon. At a depth of 1,500 feet (450m) in the earth’s crust, horizontal stresses exceed the vertical stress. *Source: Z.T. Bieniawski*

- The maximum thickness of the North American glacial ice sheets exceeded 3 kilometers. It can be demonstrated that if 20% of the vertical strain is viscoelastic, then 60% of the horizontal stress may remain. Thus, with each advance and retreat of the glaciers (Nebraskan, Kansan, Illinoian and Wisconsin), residual stresses accumulated. This, along with the previous (Jurassic Age) 3.5 kilometers of uplift and erosion, accounts for the today's high horizontal stresses. (A similar scenario may be responsible for very high horizontal stresses found elsewhere in the temperate zones of both the North and South hemisphere.) *Source:* Asmis and Lee
- The azimuth (orientation) of the principal stress is not necessarily uniform with depth; frequently, it has been found to rotate horizontally. One reason that oval or elliptical shafts should not be considered is the horizontal rotation; two others are cost and schedule. *Source:* Jim Redpath
- Some stress measurements taken underground indicate a very high ratio between the principal stress and minor stress. Invariably, it is found that these measurements were taken (by necessity) near mining operations, the induced stresses from which make the readings suspect. In addition, it is likely found that measurements in different directions were not taken at the same location underground. *Sources:* Wilson Blake and S. G. A. Bergman
- In the typical rocks of the Canadian Shield, the horizontal stresses exceed the vertical for any depths of mining now contemplated. The ratio decreases with depth until at approximately 750m (2,300 feet) the ratio is approximately 1:1.5, and at a depth of 3,000m (10,000 feet) the average horizontal stress is equal to the vertical stress. *Source:* Dr. G. Herget
- In the typical Precambrian rocks of the Canadian Shield, the principal stress (maximum horizontal component) exceeds the minor stress (minimum horizontal component) by 20 - 30%. *Various Sources*, including Asmis, Lee, Herget, Pahl, Oliver, Haimson, Sbar and Sykes
- In the hard rocks of the Shield, the azimuth of the principal stress typically trends between East and NNE. *Source:* anonymous
- The average horizontal stress in the Shield can be determined as a function of depth by two straight-line relationships with a break at 900m, as follows.

Average horizontal stress gradient (0-900m) = 9.86 MPa + 0.0371 MPa/m

Average horizontal stress gradient (900-2200m) = 33.41 MPa + 0.011 MPa/m

Here it should be noted that the horizontal stresses measured at Timmins and Sudbury in Ontario are significantly higher than the average for the Shield. For example, the stress gradients in the Sudbury basin are described as follows.

Average vertical stress gradient = 0.0294 MPa/m (1.30 psi/foot)

Major horizontal stress gradient = 10.86 MPa + 0.0419 MPa/m (1575 psi + 1.85 psi/foot)

Minor horizontal stress gradient = 70% of major horizontal stress gradient

Source: Dr. G. Herget and Allan Moss

2.5.2 Induced Ground Stress

Two separate classifications of induced ground stress exist. The first is static, similar to virgin ground stress in that it is relatively stationary. The second is dynamic and moves through the rock mass at the speed of sound. Dynamic stress is normally referred to as a seismic stress.

Static Stress

When the miner excavates an opening underground, the stresses in the rock surrounding the void increase due to the fact that he has put a hole in the virgin stress field. The increase is called an "induced" stress.

The induced stress is best demonstrated by considering the case of a vertical shaft in a uniform horizontal stress field. By elastic analysis, the circumferential stress at the skin of the shaft wall is *double* the *horizontal* ground stress that existed before the shaft was sunk, and then decreases with depth into the wall rock.

The magnitude of the additional induced stress (Q_i) at the skin and any distance into the wall rock may be calculated by simple elastic analysis with the Spalding formula.

$$Q_i = Q[r^2/(r + y)^2]$$

Q is the original virgin ground stress, r is the radius of the shaft, and y is the distance into the wall rock (at the skin, $y = 0$, therefore, $Q_i = Q$).

This theory is close to the truth if the shaft is round and perfectly smooth (i.e. a drilled shaft), regardless of the shaft diameter. It is also virtually true for a shaft pilot hole that was diamond drilled, even though its diameter is many times smaller than the shaft. Additionally, the theory is the case for the blastholes in the shaft bottom, whether drilled by a plugger or jumbo.

In hard rock, the magnitude of this stress at the skin of the shaft wall is actually closer to zero if the shaft is conventionally drilled and blasted. In this case, the horizontal stress is only increased by about 50%, and this maximum increase in stress is found at some distance into the wall rock (i.e. in the shaft pillar). The distance to this maximum stress depends on and is roughly proportional to the shaft diameter. The shaft wall between the skin and the zone of maximum stress is referred to in the literature as "the relaxed zone." In this area, the differential stress between the skin and the zone of maximum stress is believed to be the cause of the cracks that tend to form in a ring around the shaft perimeter. These cracks may be entirely independent of the rock formation and can be found to cut across natural slips, joints, and contacts between different rock types. In heavy ground the crack(s) may be visible in the back of a shaft station that has been cut around the full perimeter. If the station floor is concreted it also may later crack in a concentric circle around the shaft as the result of heave.

The induced stresses around shafts can be illustrated as follows.

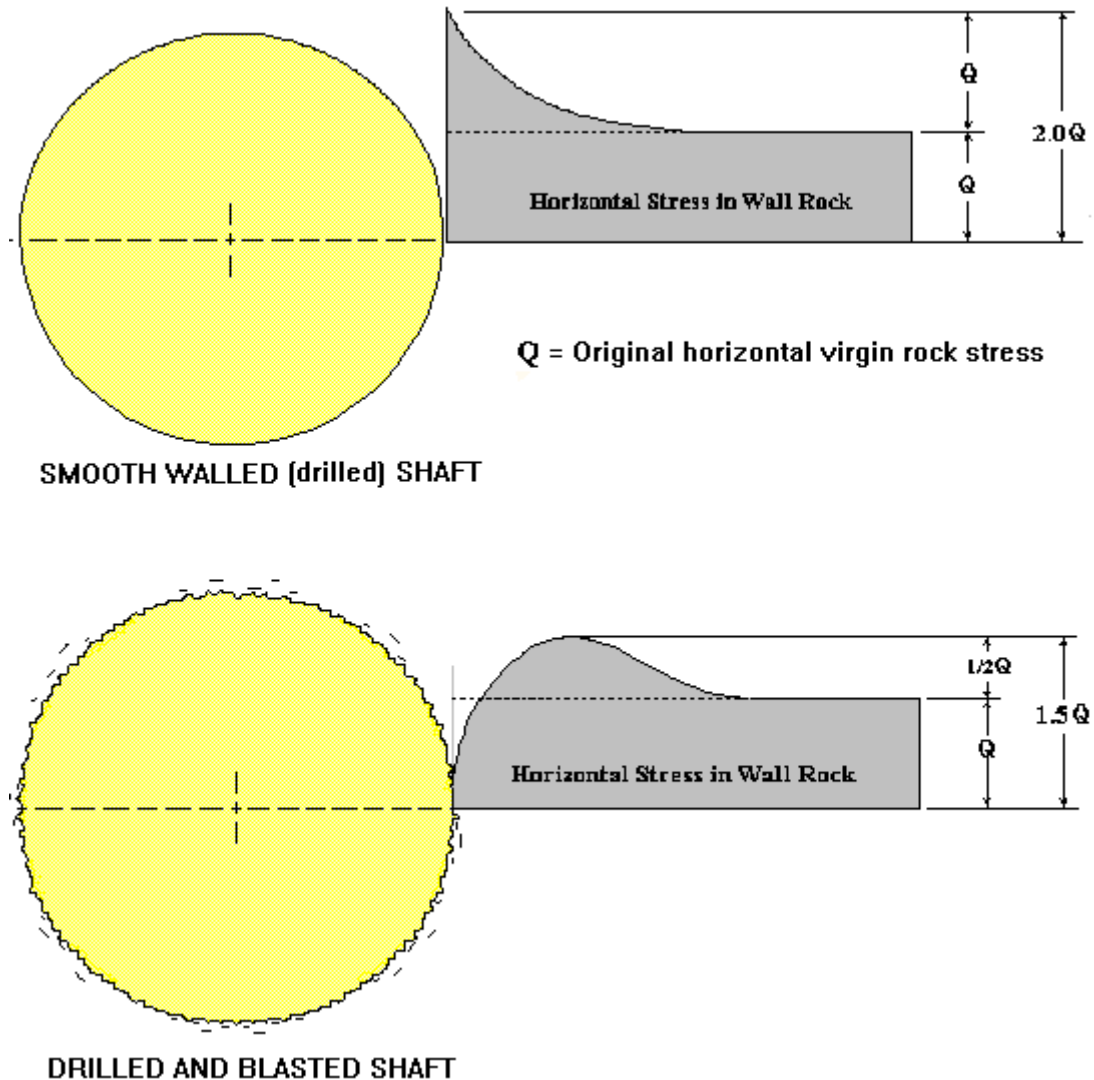

Figure 2-1 Induced Stresses around Shafts

Seismic Stress

An event such as a round being shot or a fault slip produces a seismic response that is a sudden alteration in pressure, stress, particle displacement, and particle velocity, propagated in waves through an elastic medium. In rock mechanics, the rock mass is the medium, and it is often possible to hear a seismic wave as a noise, similar to a hammer blow or blast.

Miners tend to associate the word “seismic” with earthquakes. There is a similarity between the seismic response from an earthquake and a seismic event in a mine, but these phenomena are usually vastly different in scale, although the mechanism of an earthquake (slip on a fault) is similar to a class of large rockbursts.

2.6 Ground Control

Ground is controlled in the first instance by proper mine planning. This means controlling the extraction geometry and sequence in such a way that stress levels and failure zones in the surrounding rock are kept below some threshold or potential for failure. It is not always possible to keep stresses low, and in these cases support can be installed to control fractured ground. Support is also used to keep blocky ground from unraveling and resulting in unexpected groundfalls.

The following techniques can be used to manage stress and accomplish control.

- Avoidance (change heading location and alignment)
- Excavation shape (can change stresses from tensile to compressive)
- Reinforcement (can provide the rock with additional strength)
- Reduction (i.e. leave protective pillars)
- Resistance (provide ground support)
- Displacement (alter the sequence to “chase it away”)
- Isolation (“keep it away”)
- De-stressing (actively change the stress by blasting)

Some ground control techniques serve more than one of the above functions. For example, a rock bolt may provide for alteration of, and resistance to, ground stress.

Avoidance

Stress is avoided in the first place by aligning entries, headings, and boreholes to miss treacherous fault zones, dykes, sills, old workings, and zones of subsidence by a wide margin. When a problem fault must be traversed, the heading is aligned to meet it at near a right angle, rather than obliquely.

Stress concentration is avoided by rounding the corners in a rectangular heading.

Excavation shape

Tensile and bending stresses are altered to compressive stresses when the back of a heading is arched. The same is true of a shaft or raise that is changed from a rectangular to a circular cross-section.

Reinforcement

The ability of the rock mass to resist shear, tensile and bending stress is reinforced when a cable bolt is tensioned because the friction in joints and fractures is increased. Note that the opposite is also possible, for example when an ungrouted exploration diamond drill hole provides a conduit for ground water to reach a rock mass that was otherwise dry. The water lubricates joints and fractures in the rock and may destroy cohesion at lamination contacts. The water pressure can also reduce the normal stress and therefore the frictional resistance to displacement. Friction in joints and fractures may be restored if boreholes divert the flow (and therefore reduce the pressure) and drain wet ground or if injection grouting can cut off the flow and reduce the pressure.

Reduction

The ground stress around one heading arising from its proximity to another opening is reduced by a protective pillar (safe distance) between them.

The magnitude of the ring stress is reduced (and displaced) if a circular shaft or raise is advanced by drilling and blasting instead of raiseboring, because the fractured zone “pushes” the peak stress some distance into the solid rock.

Controlled (“smooth wall”) blasting techniques are used to minimize overbreak and crack propagation; however, their introduction to highly stressed ground may have another, negative effect (ring stress concentration). To reduce stress in deep shaft sinking, it is typical that smooth wall blasting is abandoned near the horizon where discs were first observed in the pilot hole drill core.

Many rules of thumb relate to the safe distance between excavations underground. The rules generally relate to the equivalent diameter of one of the two headings (i.e. 1½ diameters, 2 diameters, or 3 diameters). A logical way to determine the safe distance for good ground in a hard rock mine is to consider the calculated decay of the induced stress around the opening by simple elastic analysis. For a typical application in good ground, it can be assumed that the minimum distance is that where the induced stress from one hole is significantly reduced at the other. When these calculations are completed for a variety of situations, they demonstrate first that the larger sized heading or room governs the required distance (pillar dimension) and secondly that no rule of thumb is applicable, except by coincidence. (If one of the excavations is an ore pass, waste pass, or bin, the distance calculated should be increased to account for wear and sloughing.)

Resistance

Stresses are resisted with ground support. The support may consist of sets (wood or steel), rock bolts, cable bolts, shotcrete, screen, strapping, or concrete. Ground support is commonly evaluated for comparison purposes by the average pressure that it is calculated to exert against the rock face.

Poorly blocked sets provide a resistance that is near zero. Properly blocked sets of wood or steel provide resistance in the order of 10 psi (70 kPa). So do pattern rock bolts if fully tensioned by slight deformation of the rock. The normal concrete lining in a circular shaft has the strength to provide in the order of 300 psi (2 MPa) of resistance; however, its role in hard rock is normally a passive one and the resistance that concrete lining is required to provide is typically near zero. (Refer to Chapter 9 – Shaft Design.) Screen and strapping also provide minimal resistance; their role is to control loose. When a screen becomes filled with loose, it forms a catenary that exerts “back pressure” to inhibit further raveling.

Table 2-1 compares resistance values (maximum theoretical ground support in a direction normal to the face) and other data for some different ground support mechanisms in a typical mining application.

Table 2-1 Resistance Value Comparison

	Plain Shotcrete	Reinforced Shotcrete	Thin Sprayed Liners ¹	Rock Bolts	Plain Concrete	Reinforced Concrete
Nominal Thickness	50mm	75mm	2mm	–	300mm	300mm
Excavation Diameter	6m	6m	6m	6m	6m	6m
Maximum Theoretical Ground Support	100 kPa (15 psi)	125 kPa (18 psi)	100 kPa (15 psi)	70 kPa (10 psi)	2,000 kPa (300 psi)	2,200 kPa (330 psi)
Collapse Deformation	5mm	8mm	100mm	250mm	0.5mm	1mm
Compressive Strength	30 MPa	30 MPa	NA	–	25 MPa	25 MPa
Tensile Strength	3 MPa	10 MPa	5-10 MPa	275 MPa	3 MPa	8 MPa
Rebound Loss	5-25 %	5-30 %	1%	–	–	–
Seismicity²	Low	Fair	Low	Low	Fair	Fair
Corrosion Resistance	Good	Fair	Good	Fair	Good	Good
Overall Cost	Low	Medium	Low	Low	High	Very high

¹ Recent technology that now shows promise for practical application, but all values provided must be used with caution – they are very early estimates only.

² Protection against rockbursts

The support tool most employed in hard rock mines is the rock bolt. The traditional mechanical rock bolt (“point anchor” with an expansion shell) has been largely replaced in hard rock mines with resin bonded steel bolts for permanent headings and friction (split-set) bolts for temporary (~6 months) support. Other types of rock bolts see occasional application and cement grouts or cartridges have been used instead of resin cartridges.

The traditional mechanical bolt was torqued at installation to 50-60% of the tensile strength of the bolt and it was considered that this tension had to be maintained for the bolt to remain effective. These bolts were sometimes very difficult to install properly. Over a period of time, the mechanical anchor was subject to creep in the hole resulting in loss of tension and a maintenance chore to re-torque or replace bolts.

Problems with mechanical point anchors in weak rock led to the development of the resin rock bolt. Initially, a single resin cartridge was used to end anchor the bolt. But as the “beam building” theory gained acceptance, the resin rock bolt was fully bonded with several cartridges. In beam theory, the high shear resistance of a fully bonded anchor is an asset. By using resin cartridges of different setting speeds, a resin rock bolt may be tensioned and still maintain the benefits of full column bonding. This tensioning is not always necessary. A simple calculation demonstrates that a ground dilation (strain) in the order of one-eighth of an inch (3mm) is more than is required to fully tension a resin bolt. Current belief is that the strongest steel is the most important aspect of a resin rock bolt. For this purpose, the steel bolt now employed is a high-strength rebar or ultra-high-tensile rope thread steel thread bar (Dywidag®). A resin bolt also facilitates mechanized installation. For these and other reasons, the resin bolt has become a mainstay in hard rock mines.

Resin bolts are sometimes even specified for temporary applications when a friction bolt would be less expensive and simpler to install. The friction bolt ("split-set") was invented by a rock mechanic (Dr. James Scott) who slit one side of a thin-shelled tube so that it could be driven into a drilled hole of slightly less diameter to obtain a "bond" by friction and without the necessity of resin or cement. Unfortunately, the thin shell is subject to corrosion in the long term and the friction bond is only a fraction of that obtained by a resin bolt. Other types of thin-shell friction bolts (elliptical and Swellex[®]) later developed suffer the same problems and are not as popular in North America, although the latter has recently gained wider acceptance.

Any type of rock bolt employed will be most effective if installed soon after new ground is exposed (before the rock has opportunity to fully dilate).

Displacement

A pyramid (Christmas tree) or inverted 'V' sequence of stoping can displace stresses from zones weakened by mining activity. First developed for narrow vein mining in burst prone ground, it is now regularly employed in bulk mining of massive ore bodies.

Isolation

In deep mining, perimeter headings may first be driven around a stoping block to avoid wrongful stress transfer and minimize stress buildup in stope ends.

At the current South Deep project in South Africa, the shaft pillar at the reef horizon was deliberately mined out before shaft sinking could reach it.

It was proposed (W. F. Bawden) that a ring heading around an existing shaft will isolate it from stresses induced by future mining in the near vicinity.

De-stressing

De-stressing displaces stress away from the walls of an entry or heading and into country rock. When properly executed, de-stressing creates a failure envelope that shunts stress away from the excavation. It is a valuable tool for combating rockbursts. The evolution of de-stressing is described in the following quotations.

"When we were planning to mine a shaft pillar at the Lakeshore, it was decided to drill eight holes into the shaft walls. They were loaded with powder and blasted in the hope that they would relieve the stress. No burst occurred (when the pillar was subsequently mined out)." Source: T. Ramsay (1939)

"The skin stresses on a mine opening can be appreciably reduced by inducing above normal compressive stresses at moderate depth into the walls, and directed tangentially to the walls. The method might well receive its first application in the prevention of rockbursts."

Dr. John Reed (1956)

"De-stress holes for the shaft sinking in burst-prone ground were drilled ahead, into the walls in a direction normal to the axis of the principal stress, on each side of the shaft. Then, the bottom half of each was loaded with powder and sprung. We tried one hole on each side of the shaft and it didn't help. Then, we tried two holes on each side. It worked!"

Phil Oliver (1982)

"At a depth of 7,500 feet, a pillarless mining sequence is employed where no permanent sill/crown pillars are created. A narrow pillar width is employed for bottom sill development and these temporary pillars are de-stressed with the advance of the headings that are also de-stressed (ahead). A de-stress core is established on each level. After it is in place, panel widths may increase to a set maximum length. Center-out mining is employed in an attempt to disperse stresses from the mining area to the far field regime. This also allows mining to proceed in the stress shadow of the previous stope (overhead). Experience and numerical models are used to establish block dimensions. The maximum sill pillar width is 20 feet for 15 feet wide sills. The maximum panel strike length is 50 feet and the maximum panel width is 35 feet for the de-stress core, and 70 feet once the core is established."

Denis Thibodeau (1999)

"The effectiveness of de-stressing methods can be categorized by excavation type or geometry of zone being de-stressed. This leads to the following conclusions:

- *De-stressing of development openings (including shafts) is fairly routine and successful. Several companies have developed standards for doing this work. These standards cover drilling patterns, blast hole layouts, explosives, charging and blast details.*
- *Pillar de-stressing is often done on an ad hoc basis and is usually planned by using trial and error or past experience with similar pillars on the mine in question. Blast design is not well understood. Some mines have altered their mining methods to eliminate the need for pillar de-stressing (e.g. Lucky Friday, Campbell, Macassa). When pillars are de-stressed, one needs to be aware that the stresses will be transferred to adjacent pillars, and that this sometimes causes problems.*

- *Fault de-stressing is the most speculative technique; the mechanisms are not well understood but some interesting results have been achieved.*

On the basis of the references cited, there can be little doubt that it is possible to control violent rock behavior by means of preconditioning or de-stressing under appropriate circumstances. This technology, therefore, has the potential to be profitably harnessed for use in the mining of deeper orebodies, particularly hazardous situations such as highly stressed high grade remnants, or development into areas which are known to be prone to bursting.”

Board, Blake & Brummer, (1998)

Suggested Reading: *DE-STRESS BLASTING PRACTICES: A Review of the Literature and Current Industrial Practice*, by Board, Blake & Brummer, 1998. Report to Canadian Mining Industry Research Organization (CAMIRO).

2.7 Stability of Excavations

The application of rock mechanics (along with the advent of remote control mucking) has enabled the introduction of open stoping to ore bodies that were previously only mined by tedious cut-and-fill methods. This has been accomplished by increasing the hanging wall span that can be exposed in an open stope while controlling the increased tendency for dilution. This important evolution has enabled greater mechanization and made economic recovery possible from ore zones that might otherwise have been abandoned.

The requirement for large spans has been met with an empirical analysis of structural stability that is dependent upon rock classification systems.

RQD, Rock Mass Rating (RMR), and Quality (Q) are the three classification systems used today in the mining industry evolved from systems first developed for civil engineering works, particularly tunnels.

RQD

Karl Terzaghi proposed the first rock classification system in 1946; the second was developed by Lauffer in 1958. One year later, Deere derived the RQD system that was adopted directly by the mining industry. Today, it remains unaltered. It is still widely employed on a standalone basis and is an important component of the RMR and Q systems described below.

RMR

In 1974 Bieniawski developed the RMR system and two years later it was modified to the (MRMR) system by Laubscher. Since then, the MRMR system was modified and expanded and a complementary In Situ Rock Mass Rating System (IRMR) was developed. Today, even the advanced systems are still generally referred to as “RMR.” This classification is widely employed by mines employing caving methods, particularly Block Caving.

The Q System

Also in 1974, Barton developed the Q system. Unlike the RQD and RMR systems that use a scale of zero to one hundred, the Q system is rated on a logarithmic scale from one thousandth to one thousand.

Later, Dr. Ken Matthews developed a modified system in which Q was simplified (ESR eliminated) and became a sub-classification called Q' (Q Primed). He added a factor to account for stress condition and another to account for joint orientation that were included in the computation for his new “stability number,” N (that replaced Q). Instead of correlating it to span, he used shape (hydraulic radius) and a plot of results was termed a stability graph.

Soon afterwards, analyzing data from 175 mines, Dr. Yves Potvin modified the N system to the N' (N Primed) system and published a modified stability graph in 1988. His work took better account of joint orientation, eliminated J_w (most stopes are dry) and introduced a sliding mode of failure. The sliding concept has since been modified and re-interpreted (Pakalnis, Clark, Bawden, Hadjigeorgiou, Leclair, Potvin, Neumann, and others) to better reflect a gravity condition. N' stability graph has become popular partly because it is readily adaptable to cable bolting and software is available to facilitate its use. Mines using N' can also plot conditions actually encountered. This evolves into to a customized graph specific to the mine. It may be used to accurately determine safe openings for a variety of shapes and conditions found anywhere underground.

Today, even the advanced procedures are still generally referred to simply as “Q.” This classification is widely employed by underground mines employing bulk methods, particularly Blasthole mining.

System Comparison

The following tabulation was created to facilitate comprehension of the three rock classification systems described above. Since the systems have different considerations in their calculation, the implied correlation between systems is deliberate but imprecise, and should only be used as a guideline.

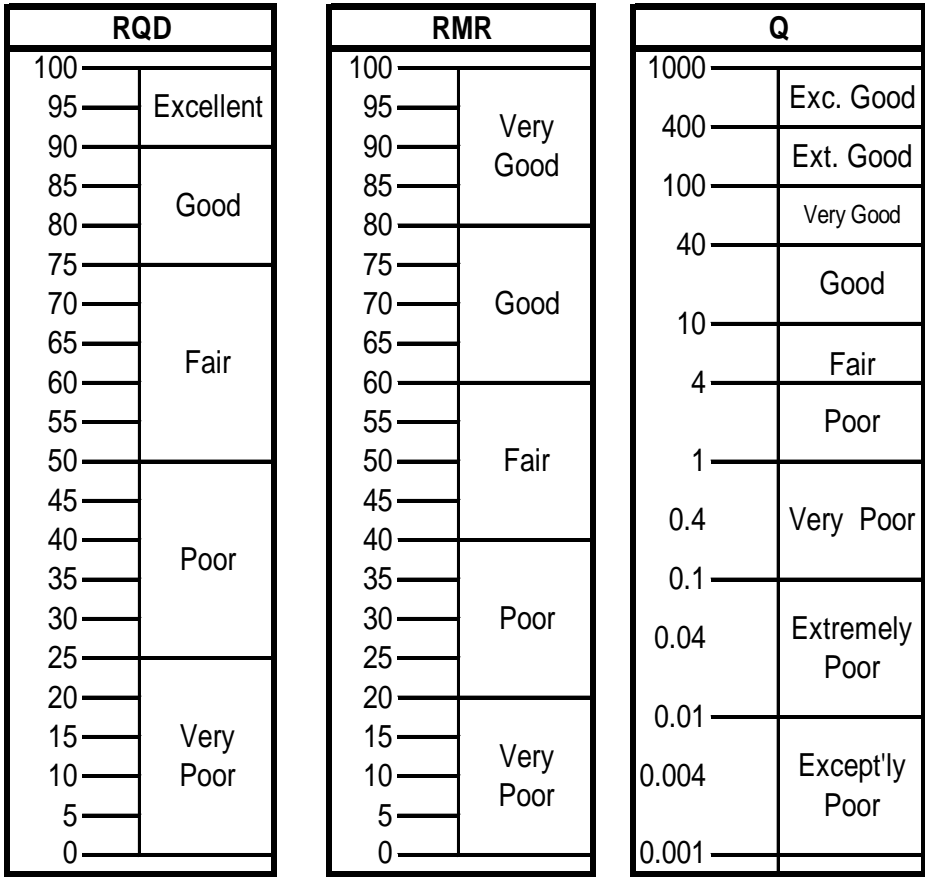

The following is a more detailed description of each of the three systems, complete with sample calculations:

RQD System

One component of the Q and N systems and their modifications is the RQD of a core sample. This is a simple rating first derived by D. U. Deere in 1964.

$$RQD = \frac{\sum \text{lengths of intact pieces of core } \geq 4 \text{ inches}}{\text{Length of core advance}}$$

Example

Determine the RQD in the following case.

- Facts: 1. A diamond drill advance is measured at 60 inches
- 2. Core lengths of pieces 4 inches or greater total 36 inches

Solution: $RQD = 100 \times 36/60 = 60$

Note

Dr. Deere meant the RQD to be determined from a core about 2 inches (50mm) in diameter. A value calculated from AQ or BQ core from a particular rock may be lower than one measured from typical (NQ or CHD 76) core from the same location.

RMR System

The RMR system first consists of the following five components, weighted to add to 100.

Compressive strength (in situ)	15
RQD	20
Joint spacing	20
Joint condition	30
Ground water	<u>15</u>
	100

For an underground application, the value obtained is then reduced from 0 to 12 to account for joint orientation.

Example

Determine the RMR in the following case.

Facts:	1.	Compressive strength (in situ)	75 Mpa	13
	2.	RQD	95%	20
	3.	Joint spacing	400 mm	10
	4.	Joint condition	no separation	30
	5.	Ground water	dry	<u>15</u>

Solution:	Total of points from list above		88
	Reduction for unfavorable dip/dive orientation		<u>(10)</u>
	RMR		78

Q System

The following equations are used in this system.

$$D_e = \frac{\text{Span}}{\text{ESR}}$$

$$Q = \frac{\text{RQD} \cdot J_r \cdot J_w}{J_n \cdot J_a \cdot \text{SRF}}$$

D_e = Equivalent Dimension
 ESR = Excavation Support Ratio
 Q = Quality Factor
 J_r = Joint Roughness Number
 J_w = Joint Water Reduction Factor
 J_n = Joint Set Number
 J_a = Joint Alteration Number
 SRF = Stress Reduction Factor

SRF = 0.5 (low stress), SRF = 1.0 (medium stress), SRF = 2.0 (high stress)

ESR = ±4 for temporary mine openings, ESR = 1.6 for permanent mine openings

$$D_e = 2.32Q^{0.37}$$

Example

Find the maximum unsupported span for a permanent underground excavation with the following characteristics (Table 2-2).

Table 2-2 Table of Observations (Facts)

Item	Description	Values
RQD	Good	RQD = 80%
Roughness	Rough Joints	$J_r = 3$
Water	Large Inflow	$J_w = 0.33$
Joint Sets	Two sets	$J_n = 4$
Alteration	Clay Gouge in Joints	$J_a = 4$
Stress Red.	Medium Stress	SRF = 1.0
Exc. Ratio	Permanent Mine Opening	ESR = 1.6

Solution: $Q = (80 \times 3 \times 0.33)/(4 \times 4 \times 1) = 4.95$ $De = 2.32 \times 4.95^{0.37} = 4.2$
 Maximum unsupported span = $D_e \times ESR = 1.6 \times 4.2 = 6.7\text{m}$ (22 feet)

N System

$N = Q' \times A \times B$, in which

$Q' = RQD \cdot Jr \cdot Jw/Jn \cdot Ja$

A = Strength Factor

B = Joint Orientation Factor

N' System

$N' = Q'' \times A \times B \times C$, in which

$Q'' = RQD \cdot Jr/Jn \cdot Ja$

A = Strength Factor

B = Joint Orientation Factor

C = Gravity Influence Factor

2.8 Rockbursts

Rockbursts are sudden, damage-causing movements that may occur in highly stressed rock. Rockbursts commonly occur on a small scale ("face bursts" or "air blasts") where small particles of brittle wall rock "spit" from the face. Less frequently, but more dangerously, slabs of rock can be blown from the wall rock. Occasionally, a larger volume of rock such as a rock pillar can fail suddenly, or a fault or other large discontinuity can slip. This can cause widespread damage in what is termed a major seismic event. Major failures can be terribly harmful sometimes resulting in multiple fatalities and mine closures.

Today the term "rockburst" is commonly defined as a seismic event resulting in more than 5 tonnes of rock coming down in an underground opening (in Ontario this size of event is a "reportable event"). A release of smaller scale is referred to as an event or simply a "noise."

2.8.1 Causes of Rockbursts

Rock Stiffness

Rockbursts are believed to be caused by high-ground stress in hard rock. Hard rock is described in literature as "crystalline," "clastic," or "elastic" rock [as opposed to "plastic" rock that tends to squeeze (creep) rather than burst when stressed to the yield point]. Hard rock may be described as being brittle or "stiff." The measure of stiffness is Young's modulus of elasticity, E .

"All rock at depth is in a state of compression and awaits an opportunity to expand. The pressures encountered in deep mining are so great that the potential energy locked up is enormous. Rock suddenly released of stress shatters itself and this is what makes the failure so explosive and is responsible for the term "rockburst."

Jack Spalding

"Brittle failure is said to occur when the ability of the rock to resist load decreases with increasing deformation. Brittle failure is often associated with little or no deformation before failure and, depending on the test conditions, may occur suddenly and catastrophically. Rockbursts in deep hard rock mines provide graphic illustration of the phenomenon of explosive brittle fracture."

Hoek and Brown

"Larger seismic events (rockbursts) are associated with major known geological structures such as dykes and faults."
 Spottiswoode and McGarr

"The surface of the discrete feature (discontinuity such as a dyke intrusion, small local fault, geological contact, etc.) is rough and/or has 'locking-up' geometric asperities, thus resisting slippage and storing large amounts of energy in the process. When slippage occurs (either because the driving stress has become higher than the shear strength of the feature, or the perpendicular clamping stress has been removed), it can instantly release very large amounts of energy."
 Simser and Andrieux

These classic descriptions of the cause of rockbursts are not satisfactory when the following four facts are considered.

- Rockbursts are known to occur at stress levels well beneath the yield strength.
- Rockbursts are known to occur in mines where the rock is far from brittle.
- Rockbursts are known to occur without the presence of geological discontinuities.
- Seismic recordings of rockbursts often do not produce the saw-tooth curve that indicates the stick-slip behavior that is characteristic the fault-related earthquake.

Elastic Instability

A plausible solution to the paradox lies in the Strength of Materials science, where it is long recognized that a slender column, plate, or shell may fail by buckling long before yield stress is reached. This phenomenon is not confined to brittle materials; it also occurs in ductile steel. "Local buckling" is the term used when an element of a structure fails in this manner. When a significant portion of the whole structure fails instantly and catastrophically, the term used is "general instability." General instability failure is characterized by abrupt and violent collapse accompanied by instantaneous release of energy, one component of which is a loud noise resembling a thunderclap. The stress at which failure occurs is not predictable, only the minimum stress level at which it can occur can be determined and used as a criteria for safe design (Timoshenko's Theory of Elastic Instability).

Timoshenko's theory explains how a sliver of wall rock (or fault surface rock) exfoliated by a seismic wave (or tension resulting from cooling) can fail (local buckling) with an "air blast" at a stress level well below yield. It also provides an explanation of why a "bump" (general instability) is unpredictable and why it may even take place in ground that has exhibited significant plastic deformation, such as may occur when mining in salt domes.

The results of micro-seismic tests reported by the USBM in 1945 appear to support the concept of local buckling. Table 2-3 lists the lowest percentage of total compressive strength at which a micro-seismic event was first detected for some different types of common rocks subjected to compression.

Table 2-3 Compressive Strength

Rock Type	Basalt	Dolomite	Granite	Limestone	Sandstone	Schist
Detection as % of UCS ¹	16%	8%	13%	10%	33%	25%

¹ Ultimate Compressive Strength

The theory of elastic instability is well understood by specialists in the design of pressure vessels, off-shore drill platforms, and hydrostatic linings for drilled shafts; however, it appears to have escaped serious consideration by geoscientists, in particular the concept of general instability.

Shallow Rockbursts

While rockbursts most often happen deep in a mine, they can occur in shallow workings. For example, rockbursts have occurred in the tunnels driven under New York City. They can even occur in open pits, such as the bottom heaves that occurred in the Dumfries Quarry on the Niagara escarpment.

2.8.2 Combating Rockbursts

Screen

Just as insulation on wiring will not protect it from a lightning strike, typical ground support (rock bolts, shotcrete, timber, or concrete) is not effective by itself to prevent rockbursts or major seismic events. Screen is valuable because it can contain flying rock from air blasts. The screen is more effective when covered with shotcrete.

Procedures

Several procedures are now employed to deal with rockbursts (reduce frequency and severity). The first three are directed at ground stress. One is isolation from ground stress, the second is alteration of the stress field to advantage, and the third is designing and cutting excavations to minimize the effects of stress. These three procedures are described previously in this chapter.

- The fourth is simply to wait for ground to stabilize after a blast before allowing man entry to an advancing stope face or heading.
- The fifth is to design stope blasts to induce a rockburst simultaneously with the explosion, thus restoring ground stability.

- The sixth is to induce complete failure of a pillar around a heading or a support pillar in a stope, thus rendering it incapable of carrying high loads.
- The seventh is seismic monitoring; an advanced science that is difficult to describe in lay terms.

Monitoring Ground Stress

Seismic tools are valuable to monitor the ground stress regime, but they do not prevent or predict rockbursts. The tools' role is to provide an essential device to implement the total rock mechanics program aimed at avoiding or mitigating problems with ground stability.

Prediction

Miners know that when spitting and air blasts become frequent events ("the ground starts talking"), and loose develops in ground that was previously scaled to solid, it is time to beware. (The Russians have noticed that drill cuttings much coarser than usual are an omen.)

Seismic Monitoring System

At a hard rock mine with a high stress regime, a seismic monitoring system is installed to apply science to the miners' observations. The system monitors the distribution of rock noise due to rock failure as a result of stress changes caused by mining activity. High stresses in the rock mass generate micro-fractures and induce movement along geological structures. The resulting "noises" (acoustic events) are detected by receptors placed at strategic locations underground. The classic receptors are geophones connected to a (now) whole waveform MP-250 system originally developed by the USBM. Updated versions are capable of detecting acoustic emissions up to 1,000 hertz (cycles per second). This system is limited to counting impulses and source location to within 10m (by timing), but this is enough to enable man re-entry decisions.

Advanced Systems

More elaborate systems have been developed and have won wide acceptance. These are full waveform or digitized systems that convert voltage functions from "accelerometers" (that replace the geophones) triggered by ground motion into digital records which are then stored on computers and analyzed. This allows for on-line accurate event locations and estimates of source parameters (i.e. seismic energy and stress release) over a broad range of magnitudes (from micro-seismic to macro-seismic events).

The accelerometers are usually installed in drilled holes 1¼ inches in diameter. They are individually connected to a junction box on each level. Each junction box is hard-wire connected to a centrally located "multiplexor." The multiplexor gathers all the signals from each level and sends the data to surface to a surface de-multiplexor via a primary mine entry in two-strands of the mine's fiber optic cable. The data is then transmitted for processing to a PC that is running the micro-seismic monitoring system for processing.

The more popular of these advanced systems downloads the on-line calculated parameters into a Microsoft Access® seismic database and the results may be viewed on a Microsoft Excel® spreadsheet and AutoCAD® for Windows. Mine levels, mine sections, and 3-D drawings created in AutoCAD® or imported from other numerical models are used to view event source locations. Automatic reporting and plotting of events is also provided on a daily basis or whenever necessary. The program can run on-line showing current activity in real time or be used off line to view data collected over longer periods. This system can also provide information on an off-shift basis through a foreman/supervisor terminal set up in the control room.

2.8.3 Simple Truths about Rockbursts

In a keynote lecture presented to the South African National Institute of Rock Engineering (SANIRE), and later at the Australian Centre for Geomechanics, Brummer (1999, 2000) described several "Simple Truths about Rockbursts," based on experience in South Africa and Canada. Some of these are presented below.

- Orebody and excavation shape usually determine whether rockbursts will be experienced.

Most South African gold orebodies are similar in shape (i.e. narrow tabular reefs) and are also burst-prone. They share this geometric characteristic with other orebodies that are also burst-prone, i.e. the Kolar gold mines of India, Red Lake (in Canada), and Kirkland Lake (in Canada). Plug-shaped orebodies are not generally as burst-prone as tabular orebodies. Simply put, tabular is the worst and ovoid or plug shaped is the best. A crude representation of the differences between these shapes is provided below.

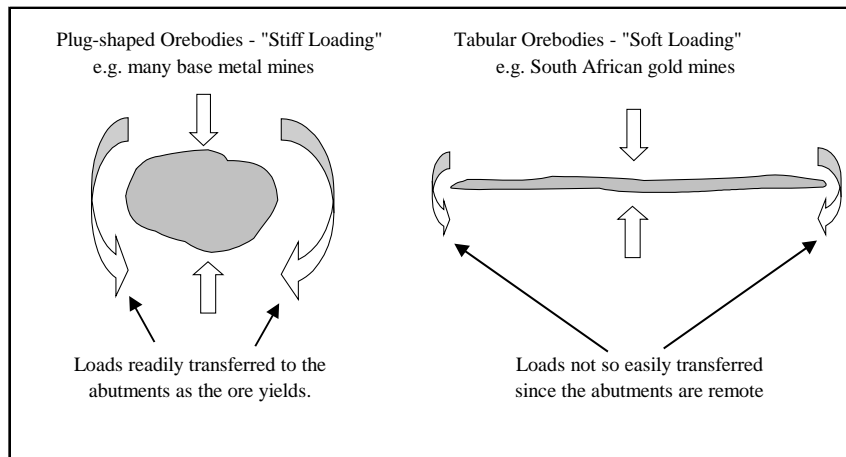

Figure 2-2 Orebody Shapes

- Rock type matters.

Quartz-rich rock types seem to be the most burst-prone. Many gold mines are found in planar faulted zones, in association with quartz infilling that welds the pre-existing fault closed. This makes these mines more prone to rockbursts. In the nickel mines of Sudbury, the nickel sulfide ore is hosted at the contact between a granite gneiss and a norite. Of these two, the granite is by far the more burst prone.

- Fault slip events are responsible for the larger rockbursts.

Mining-induced seismic events larger than magnitude 3 (Richter or Nuttli) usually can be blamed on faults, which almost always daylight into the mine opening. The displacement on the fault is usually not large, and it is often not even possible to tell the sense of movement. But the fact that the fault has moved is usually apparent because of the damage is localized where the fault daylights into the mine opening.

- Microseismicity occurs where the stress changes.

Microseismicity occurs not where the stresses are highest, but where the stresses have changed by the largest amount. After a mining step (when the stresses are high enough) the rock adjacent to the mining excavation fails and the stresses readjust. This means that the rock adjacent to the excavation is in a state of limit equilibrium, and will continue to fail as the next mining step is taken. In a brittle rock type, this failure occurs with accompanying microseismic activity, and this activity is greatest where the stress change is the largest.

Since mining activity will redistribute stresses, some degree of microseismicity will occur with all mining, if the stresses are high enough. The microseismic activity is useful, since it dissipates energy, and provides information about the state of failure of the rock.

- Accurate locations and times are by far the most important parameters obtained from a microseismic system.

The most useful parameters to have are an accurate event location and time. It is also important to have this information immediately. North American mine operators are usually obliged to evacuate the mine if an unexpected event such as a large rockburst occurs. Having the event's location (as well as a means of communicating with the workforce) usually makes evacuation unnecessary, and can save many millions of dollars in unnecessary downtime. This use represents the short-term operational utility of the microseismic system and easily justifies the cost of installing and running a microseismic system. Almost all North American mines that experience some level of microseismic activity operate at least such "location and time only" systems.

The next most useful microseismic parameter is some form of magnitude (Richter, Nuttli, Local Richter, Moment, Number of phones hit, duration, etc). This allows one to develop a statistical understanding of the nature of the activity, and to predict how frequently these events ought to be occurring. This represents the medium-term engineering and planning utility of a microseismic system.

Other seismic parameters seem to have limited use at this time, although some mines do operate very sophisticated full-wave microseismic systems. Microseismic systems that miss events during or just after blasts are at a significant disadvantage, since many (often large) events occur just after blast time.

It goes without saying that production personnel in the mine need to have a "hotline" or similar means of communicating with the microseismic system operator. This communication link is one of the most important assets a mine can have.

- The Gutenberg-Richter Frequency/Magnitude law works well for rockbursts.

Typical seismic data for a large Canadian mine over an eight-year period are tabulated in Table 2-4.

Table 2-4 Record of Rockbursts from a Large Canadian Mine (Eight-Year Period)

Nuttli magnitude limit	Number of events larger during record	Number of events larger per annum
1.5	127	15.875
2.0	91	11.375
2.5	36	4.500
3.0	7	0.875
3.5	3	0.375
4.0	1	0.125
4.5	0	0.000

If a line is fitted to a plot of the logarithm of the number of seismic events larger than a certain magnitude against the magnitude, it can be defined by two parameters, as shown in Figure 2-3. The two parameters are the slope (b-value), which governs the relationship between large and small seismic events, and the intercept (a-value) on the vertical axis for $M = 0$, which governs the seismic event rate. This is usually expressed by the following formula.

$$\log N = a - bM, \text{ where}$$

N = number of seismic events (per year) larger than M

This powerful relationship between the small and the large seems to apply over an incredibly wide range, from the smallest microseismic events, to the largest crustal earthquakes.

For comparisons between mines or different time periods in a mine, it is best to plot the number of seismic events per year (N/yr) rather than the cumulative N over a number of years.

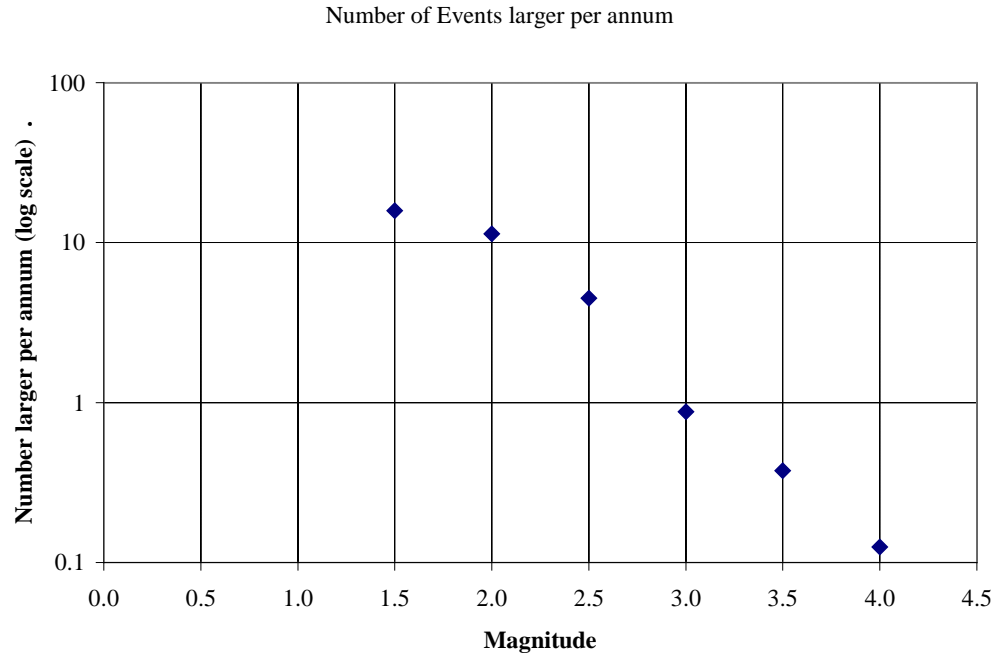

Figure 2-3 Number of Events Larger per Annum vs. Event Magnitude

- Statistical analysis is useful.

Statistical analysis is useful to determine recurrence times and probability of occurrence of events. This helps one to quantify the risk faced by the personnel in the mine. To do this, it is necessary to know the probability that a seismic event of a given magnitude will occur during a given time period. It can usually be assumed that there are upper and lower limits to the range in magnitudes of interest, so the double truncated Gutenberg-Richter frequency-magnitude relationship (Cosentino et al. 1977) is appropriate.

$$P[E > M] = \begin{cases} 1 & \text{for } M < M_{min} \\ \frac{(e^{-\beta M} - e^{-\beta M_{max}})}{(e^{-\beta M_{min}} - e^{-\beta M_{max}})} & \\ 0 & \text{for } M > M_{max} \end{cases}$$

where:

β = $b \ln(10)$ or $2.3b$, and

$P[E > M]$ = probability that a seismic event E has magnitude greater than M .

Benjamin (1968) derived a seismic hazard function by showing that the unconditional probability of occurrence of a seismic event E larger than magnitude M , during a future time period Δt , is given by the following formula.

$$P[E > M, \Delta t] = 1 - \left[\frac{t_R}{(t_R + \Delta t P[E > M])} \right]^{n+1}$$

where:

Δt = future time period of interest

t_R = monitoring period; and

n = number of seismic events in the data set.

Equations (2) and (3) can be applied to a seismic record such as that shown in the table above to produce the magnitude/hazard/time (MHT) plot shown in Figure 2-4.

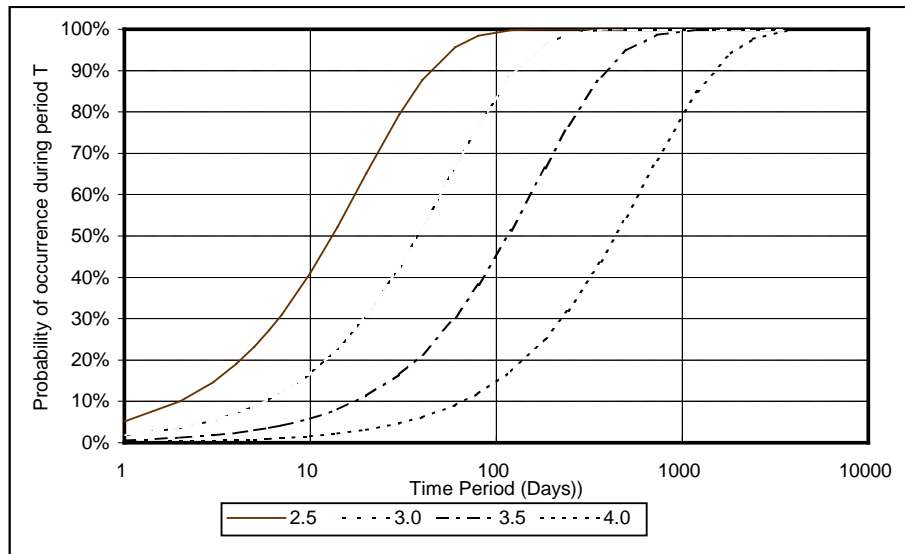

Figure 2-4 Magnitude/Hazard/Time Plot for Seismic Events at a Typical Large Mine

Figure 2-4 shows that for this mine, there is roughly a 15% probability of occurrence of a seismic event with magnitude greater than 4.0 during any future time period of 100 days. There is also a 40% probability of occurrence of a seismic event with magnitude greater than 4.0 during any future time period of one year and virtually a 100% chance of such an event in ten years. This knowledge can be used in making design decisions and evaluating the risks faced by a mine.

- We still cannot predict rockbursts.

In spite many years of effort and research into precursory phenomena, we still cannot predict rockbursts. Nor are we much closer than we were 20 years ago. We cannot predict earthquakes either, and the earthquake seismologists have been trying to do this for a lot longer, and with more money to fund them. The time must come soon when we will face the fact that we may never be able to predict rockbursts. We must learn to live with this fact, and make the best use of the information and tools we have available to us. Informed opinion suggests that, at best, a small improvement in risk evaluation may be achieved by using the most sophisticated microseismic source parameters. *Source: Stewart & Spottiswoode, 1996*

- Many rockbursts occur at blast time.

This seems to be true whether blasting operations are centralized or not. This means that continuous mining has an inherent disadvantage in that it will eliminate the very healthy blasting that triggers bursts when no one is in the mine. Canadian mines usually plan large blasts for the last shift before an off day, to allow sufficient time for the post-blast seismic activity to settle down.

- The larger the rockburst, the more random the pattern in time of occurrence.

Microseismic data from many areas shows that the smaller microseismic events tend to be concentrated at or just after blast time, on average. The larger the event, the more random its time of occurrence.

- Falls of ground (FOG) are usually larger than rockbursts.

Data on reportable incidents from several mines of one company are shown in the Figure 2-5. It is evident that FOG are, on average, about ten times larger than FOG that occur during rockbursts. For example, while the upper 20th percentile of all rockburst FOG are above 60 tonnes, the upper 20th percentile of all FOG (which occur without a recorded seismic event) are above 1,000 tonnes.

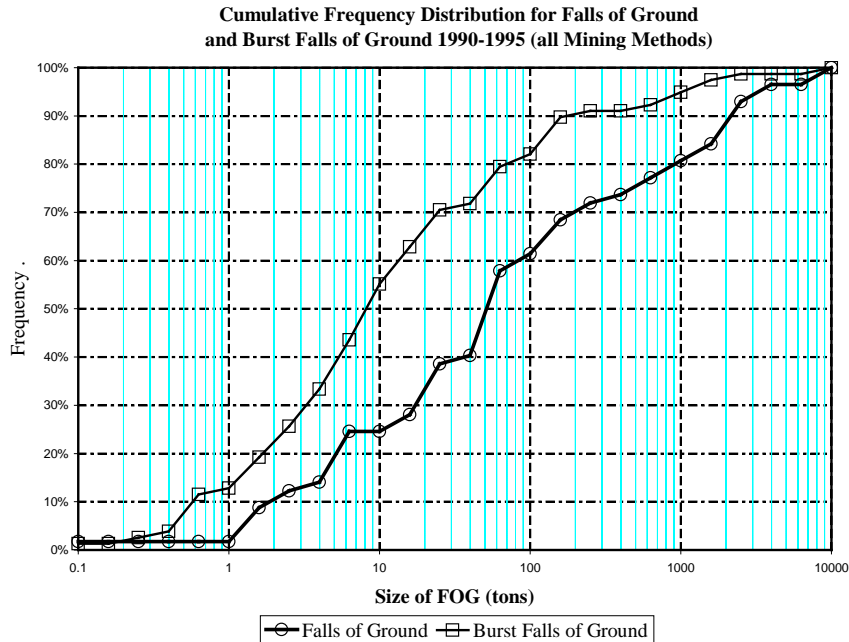

Figure 2-5 Falls of Ground Compared to Rockbursts

- De-stressing works.

On the basis of much published work, there can be little doubt that de-stressing does work. It is possible to control violent rock behavior by means of preconditioning or de-stressing under appropriate circumstances. This technology, therefore, has the potential to be profitably harnessed for use in the mining of deeper orebodies or particularly hazardous situations, such as highly stressed high-grade remnants, or development into areas known to be prone to bursting. De-stressing of development openings (including shafts) is fairly routine and successful. Several companies have developed standards for doing this work, which cover drilling patterns, blast hole layouts, explosives, and charging and blast details. Pillar de-stressing is often done on an ad hoc basis and is usually planned by using trial and error or past experience with similar pillars on the mine in question. Blast design is not well understood. Some mines have altered their mining methods to eliminate the need for pillar de-stressing (e.g. Lucky Friday, Campbell, and Macassa). When pillars are de-stressed, one needs to be aware that the stresses will be transferred to adjacent pillars, and this sometimes causes problems. Face de-stressing is mainly relevant to longwall operations (South African gold mines and German coal mines). Only German coalmines have adopted face de-stressing on a routine basis.

- Shotcrete is very effective.

Shotcrete appears to be very effective at preventing face bursting, and in “toughening up” mesh or screen-based support. At least one Canadian mine has taken steps to change to shotcrete and bolt-back support instead of screen and bolts. The major reason is that the shotcreting and bolting operations can be automated, but placing screen cannot.

Although theoretically, the various forms of yielding support elements should be effective at minimizing rockburst damage, these (unfortunately) seem not be implemented in practice. Anecdotal evidence suggests that they do not perform as expected, and the additional effort in installing them is not justified by improved performance.

- Decision making can only be done by quantifying the risks involved.

The most powerful way (perhaps the only rational way) to make decisions in the face of uncertainty is by evaluating all risks, costs, and benefits of the various different options. Since we cannot predict rockbursts, yet we can evaluate the probability of occurrence of a seismic event, we can say something about the risks faced by people in the mine. Operators have an obligation to make such risks known to the workforce, as well as to the shareholders of the company.

2.8.4 Anecdotes of Rockburst Experiences

- *“The No. 5 West sub-vertical shaft is a five-compartment, circular, concrete lined shaft, 22 feet in diameter. At 2:20 PM on April 26, a seismic event (rockburst) occurred causing damage from the 32 Level down, a distance of 45 feet. Slabs of concrete were blown from the shaft wall below the station floor. Five buntons were either bent or torn away from the concrete lining. Guides were bent above and below the level. Severe caving took place in the station.” Source: West Dreifontein Mine*
- *“The winze (internal shaft) was ellipsoid in section, almost a circle. It had been lined to within 13 feet of the bench. The concrete lining was 30 inches thick, and the sinking had reached a depth of 5,436 feet. At 4:20 AM, on the 5th of July, during the muck cycle, after 31 buckets had been hoisted, a heavy rockburst occurred that buried everyone in the shaft. Four shaftmen were rescued alive. The bodies of nine others were recovered the next day, by which time two of the rescued had succumbed to their injuries, for a total of 11 dead. A portion of the concrete shaft lining measuring 6 feet by 6 feet had been blown away and above this the concrete was shattered and cracked to a height of 7 feet.” Source: John Taylor & Sons*
- *“At a depth of about 4,000 feet, a shaft was sunk parallel to a vertical fissure. The latter consisted of a two-foot wide gap, loosely filled with Breccia. Crosscuts from the shaft intercepted the fissure at an angle of 45 degrees. When these crosscuts approached within 20 feet of the fissure, they would blow up for a distance of 30 feet and the heading would become full of broken rock. After mucking out and tight lining with heavy timber sets, before the face met the fissure, some of the headings would blow up again, smashing the timber to match sticks. Obviously, all the ring stress became concentrated in the continually narrow band of rock remaining between the face and the fissure.” Source: Jack Spalding*
- *“At another mine, the vein was 6 to 12 feet wide and dipped at 45 degrees. When final stoping was initiated in a direction towards the shaft, the shaft timbers started to break. When 15 broke in one night, mining was discontinued. That next night the shaft blew up and was filled tight with broken rock and timber over a distance of 180 feet.” Source: Jack Spalding*
- *“In another mine at a depth of 4,500 feet, a fire occurred that burned out stope support timbers. Afterwards, the ground in the vicinity of the shaft started to work. This lasted for ten years during which time shaft timbers had to be replaced frequently. Then it was decided to drive a new heading in the vicinity of the shaft to provide for a rail loop. This drive initiated a rockburst that blew up the shaft for 150 feet and severely damaged the concrete-lined station. Then ground started to work in the crosscut 100 feet away from the shaft. This burst was not the result of a stress ring failure around the shaft (that was secondary), but rather a complete failure of the shaft pillar. The proof is in the fact that the loop drive was completed, some time later, with no trouble at all.” Source: Jack Spalding*

2.9 Acknowledgement

Stantec is indebted to Dr. Richard Brummer, President of ITASCA Consulting Canada Inc., who contributed new material and edited this chapter voluntarily.

3.0 Mining Methods

3.1 Introduction

Ore bodies come in every imaginable geometric shape. While surface hard rock mines apply the “Open Pit” method to almost any ore configuration, a large number of underground mining methods have been developed primarily in response to the requirements of differing geometry and the geomechanical properties of the host and surrounding rock.

The underground mining methods presented in this chapter are mainly applicable to hard rock mines. Softer, non-metallic ores, such as coal, salt, potash, trona (soda ash), and oil shale are often amenable to different methods than those described in this chapter.

A few of the underground mining methods, such as, Avoca[®] and Vertical Crater Retreat (VCR[®]), were patented resulting in new names for variations (Modified Avoca and Modified VCR). Moreover, different names are often applied to the same mining method (Blasthole Stopping and Longhole Open Stopping are frequently used to refer to the same mining method). Other mining method names are merely variations or closer definition of others (Sublevel Stopping is typically Blasthole carried out with more than one drill drift per level interval and Sublevel Retreat simply defines the direction of the mining).

The many underground mining methods are difficult to categorize rationally because each application depends not only on orebody geometry, but includes other considerations, such as ground conditions, grade distribution, scale of operations, as well as the presence of structures (i.e. faults, dykes, etc.).

One logical procedure to categorize mining methods is to divide them into the following three generic classifications.

- Methods producing openings naturally supporting or requiring minimum artificial support (Room and Pillar, etc.)
- Methods requiring substantial artificial support (Cut and Fill, etc.)
- Caving methods where failure of the back (roof) is integral to the extraction process (Block Caving, etc.)

A more popular way to categorize mining methods is to divide the mining methods into bulk mining (Blasthole, etc.) and selective mining (Drift and Fill, etc.).

3.2 Rules of Thumb

Method Selection

- A flatly dipping orebody may be mined using *Blasthole* when the height of ore exceeds 100 feet (30m); otherwise, it is mined *Room and Pillar*. *Source: John Folinsbee*

Inclination

- Ore will not run on a footwall inclined at less than 50 degrees from the horizontal. *Source: Fred Nabb*
- Even a steeply dipping orebody may not be drawn clean of ore by gravity alone. A significant portion of the broken ore will inevitably remain (“hang”) on the footwall. If the dip is less than 60 degrees, footwall draw points will reduce, but not eliminate, this loss of ore. *Source: Chen and Boshkov*

Stope Development

- The number of stopes developed should normally be such that the planned daily tonnage can be met with 60% to 80% of the stopes. The spare stopes are required in the event of an unexpected occurrence and may be required to maintain uniform grades of ore to the mill. This allowance may not be practical when shrinkage is applied to a sulfide orebody, due to oxidation. *Source: Folinsbee and Nabb*
- In any mine employing backfill, there must be 35% more stoping units than is theoretically required to meet the daily call (planned daily tonnage). *Source: Derrick May*

Ore Width

- Blasthole (Longhole) Stopping may be employed for ore widths as narrow as 3m (10 feet). However, this narrow a width is only practical when there is an exceptionally good contact separation and a very uniform dip. *Source: Clarke and Nabb*
 - Sequence problems are not likely in the case of a massive deposit to be caved if the horizontal axes are more than twice the proposed draw height. *Source: Dennis Laubscher*
-

Footwall Drifts

- Footwall drifts for Blasthole mining should be offset from the ore by at least 15m (50 feet) in good ground. Deeper in the mine, the offset should be increased to 23m (75 feet) and for mining at great depth, it should be not less than 30m (100 feet). *Source:* Jack de la Vergne
-

Dilution

- A ton of ore left behind in a stope costs you twice as much as milling a ton of waste rock (from dilution). *Source:* Peter J. George
-

3.3 Tricks of the Trade

- The fundamental distinction between underground mining methods is between those that employ pillars and those that seek complete extraction in the first pass. *Source:* RKG Morrison
- If the wall rock is considerably more competent than the ore, the stope should be mined by a top-down method. If the opposite is true, mining must be started at the bottom. In the latter case, it may be advisable to leave a thin layer ("skin") of ore on the back. *Source:* Fred Nabb
- Whenever Block Caving is contemplated for a new mine, Blasthole mining should be investigated as an alternative. *Source:* Bob Rappolt
- A flatly dipping orebody is usually mined using Room and Pillar. It requires little development since open stopes can be used for haulage ways. The method is comparable to drifting and slashing so the same equipment is used for both mining and development. In thicker ore bodies, the mining takes place in stages. The top lift is driven first and the back secured. The remainder is removed by benching. *Source:* Hans Hamrin
- In sulfide ore bodies, the stoping height may have to be reduced when Retreat with shrinkage is employed due to oxidation of the broken ore. In severe cases, this method is simply not practical. *Source:* Fred Nabb
- A slot raise is normally required when employing Sublevel Retreat. This can be avoided by placing Styrofoam® blocks suspended with wire ropes against the ore wall when backfilling with cemented rock fill (CRF). For paste fill, we use a production rig to drill a hole near the wall soon after placement and back ream a cut hole 24 inches in diameter. The latter procedure is even less expensive than using Styrofoam®. *Source:* Jacques Perron
- In low-grade (low oxidation) massive sulfide ore bodies of competence and vast extent, a 200-400-foot stoping height has been successfully employed using big-hole, in-the-hole (ITH) rigs and a wide drill pattern. However, problems such as re-drilling plugged holes, hole squeeze, bottom collar ("toe") loss, hole misalignment, sulfur dust ignition, wall craters, sloughing and sliding can result in delays and dilution that are not acceptable when the ore width is finite. In this case, better over all results have been obtained using top hammer drills, traditional patterns, and a stope height of 150 feet. *Source:* Ken Lowe
- When open stope mining, an increase in the mucking rate reduces dilution, since hanging wall sloughing is time dependent. *Source:* Jerry Ran
- The ore from a flatly dipping orebody too steep for mechanized equipment may be successfully extracted by "cheating." This method is simply to drive the entries and cut the rooms at an angle from the dip thereby reducing the effective gradient. *Source:* Fred Nabb
- When the ore dip turns shallower than 51 degrees, plan an extra footwall hole to steepen the slope and prevent muck buildup. *Source:* Olav Sveta
- When mining a steeply dipping narrow vein with small-scale LHD equipment, it is helpful to have a cross slope in the floor of a drift in a narrow vein of ore so that the drive is carried out as if the vein were vertical. *Source:* Brian Robertson
- Ongoing stope development for Sublevel Caving will produce waste rock in the amount of 25% of the ore extracted and there is no place to leave any of it underground when this mining method is employed. (This factor should be considered when Sublevel Caving is contemplated as a mining method.) *Source:* John Folinsbee
- It should be considered that a high back is difficult to scale and keep safe. It may be better to dispense with arching and drive with a flat back when ground conditions permit. *Source:* Douglas Duke
- If the back of a heading is secured with split-set friction rock bolts, screen is easily applied by using smaller diameter "utility" split sets that are driven inside the existing bolts to a depth of 18 inches (0.45m). *Source:* Towner and Kelfer

3.4 Mining Method Selection

To select a mining method, certain data describing the orebody is required.

- Geological cross sections and a longitudinal section
- Level maps
- Block model (grade model)
- Geomechanical characteristics of the host and surrounding rock.

One approach is to find one or more comparable ore bodies that are being or were mined successfully and use that mining method(s) to determine the most likely methods to investigate further.

Another approach is to determine applicable mining methods and develop a short list for detailed consideration through a process of rationalization.

Following are typical considerations to be weighed in selecting a mining method (listed roughly in order of importance).

- Maximize **safety** (integrity of the mine workings as a whole or in part).
- Minimize **cost** (bulk mining methods have lower operating costs than selective extraction).
- Minimize the **schedule** required to achieve full production (optimize stope sequencing).
- Optimize **recovery** (80% or greater recovery of geological reserves).
- Minimize **dilution** (20% or less dilution of waste rock that may or may not contain economic minerals).
- Minimize **stope turn around** (cycle) time (drill, load, blast, muck, backfill, set).
- Maximize **mechanization** (trackless versus track and slusher mining).
- Maximize **automation** (employment of remote controlled LHDs).
- Minimize **pre-production development** (top down versus bottom up mining).
- Minimize **stope development** (selective versus bulk mining methods).
- Maximize **gravity assist** (underhand versus overhand).
- Maximize **natural support** (partial extraction versus complete extraction).
- Minimize **retention time** of broken ore (open stoping versus shrinkage).
- Maximize **flexibility and adaptability** based on size, shape, and distribution of target mining areas.
- Maximize **flexibility and adaptability** based on distribution and variability of ore grades.
- Maximize **flexibility and adaptability** to sustain the mining rate for the mine life.
- Maximize **flexibility and adaptability** based on access requirements.
- Maximize **flexibility and adaptability** based on opening stability, ground support requirements, hydrology (ground water and surface runoff), and surface subsidence.

Following is a list of mining methods most often employed underground listed roughly in the order of increasing cost (direct mining cost, including backfill where applicable). The order is generally true, but can be deceiving because some methods, such as Blasthole can have a wide range of costs.

Bulk Methods

- *Block Caving/Panel Caving* – columns of rock are undercut wide enough to cave under the weight of the column. Caving is initiated by undercutting the ore zone. Block Caving involves a significant capital investment in pre-production development and may be especially risky. It should only be implemented in consultation with a block-caving expert.
- *Blasthole/Sublevel/VCR[®]* – the ore is drilled in rings or by long hole and the ore is drawn off (“mucked”) as it is blasted. A common variation is to pull only the swell and leave most of the broken ore temporarily remaining in the stope to support the walls (deferred pull).

- *Sublevel Caving* – the ore is drilled in rings and drawn off (pulled) after blasting in successive lower lifts. Unless the ore dips steeper than 70 degrees, a great deal of ore may be left behind as production losses. One difficulty with Sublevel Caving concerns grade control. A gradual dilution occurs toward the end of the draw and it can be difficult to determine when it is best to stop pulling. Recovery may be improved if the draw point layout is staggered from one level to the next. One large sublevel cave operation in North America has reduced dilution dramatically. It calculates the ore tonnage in the first ring. Then, it then pulls only 70% and leaves the remainder (“deferred pull”) to be drawn along with 70% of the ore tons calculated in the subsequent ring beneath it, etc.
- *Room and Pillar/Post Pillar* – a grid of rooms is developed on a near horizontal plane, leaving pillars of ore to support the back (roof). The pillars left in the *Post Pillar* method are undersized (posts) and designed to fail in a controlled manner. Typically, a zone of low-grade mineralization or host rock (“barren”) must be mined with pay grade ore to maintain access and control stress distribution. On the other hand, *Post Pillar* (and even *Room and Pillar*) may be considered to be selective when the pillars can be arranged in zones of lower grade material, as opposed to a regular geometric pattern.
- *Modified Avoca* – the ore is drilled by long hole and drawn off in retreating vertical slices, followed closely by placement of rock fill dropped “over the bench” or “over the fill” (via access to the back of the stope from the footwall drift).

Selective Methods

- *Shrinkage* (narrow vein) – the ore is sliced off in successive horizontal lifts (overhand). Only the swell is drawn off leaving broken ore to support the walls and provide a working platform for the next lift. Narrow vein shrinkage stoping is classed as selective because it permits mining to variations in the horizontal contour of the vein and even removes pockets of ore extending into the wall rock. It is not selective with respect to the fact that once initiated, a shrinkage stope has to “take it all.” Normally, a barren portion of the vein cannot be left behind.
- *Resuing* (narrow vein) – a method that reduces dilution when the vein is narrower than the heading. Historically, a drift round was taken in two passes. First, the waste rock was drilled blasted and mucked out, then the narrow vein was slashed to recover the ore, undiluted. In most cases, waste rock quantities can be significantly reduced by innovative measures. Single pass resuing uses appropriate delay blasting to throw the ore and waste rock into separate piles.
- *Cut and Fill* (Overhand/Underhand) – access is provided by first ramping down from a cross-cut access and then taking down back in successive slices. After mucking, the stope is filled but enough space is left to mine the next slice. Mining equipment is captive unless an access ramp is employed. If underhand (undercut), slices are taken from the top down under cemented backfill or a concrete mat.
- *Drift and Fill* (Overhand/Underhand) – a modification of *Cut and Fill* in which drift sized cuts are taken adjacent to one another and, upon completion, packed with cemented backfill. The process is repeated next to the backfill once it has consolidated.

Many additional mining methods exist; the foregoing are the most commonly employed. The selection of a mining method and its application to a new orebody may be simple in some cases, but it is more often a challenge requiring not only logical and practical reasoning, but creative minds working in three dimensions.

3.5 Dilution

Modern bulk mining methods reduce direct operating costs and facilitate management of the mine operations, but a common drawback is often increased dilution. For ore bodies of vast expanse, dilution is not a problem; however, most mines deal with ore zones of finite width and many experience dilution as high as 20%, or even 25% when bulk-mining methods are employed.

Dilution is the great nemesis for miners because the cost of dilution is not only the obvious direct cost (dilution tons displace ore tons in the ore handling and process circuits), but also includes significant indirect costs. For example, each ton of sterile rock or backfill that circulates through the mill carries mineral values with it to the tailings. The minimization of dilution should be given weight in the selection and subsequent application of a mining method. The causes of excess dilution include using the wrong mining method and related factors. The causes can be illustrated in the following fish-bone chart (Figure 3-1).

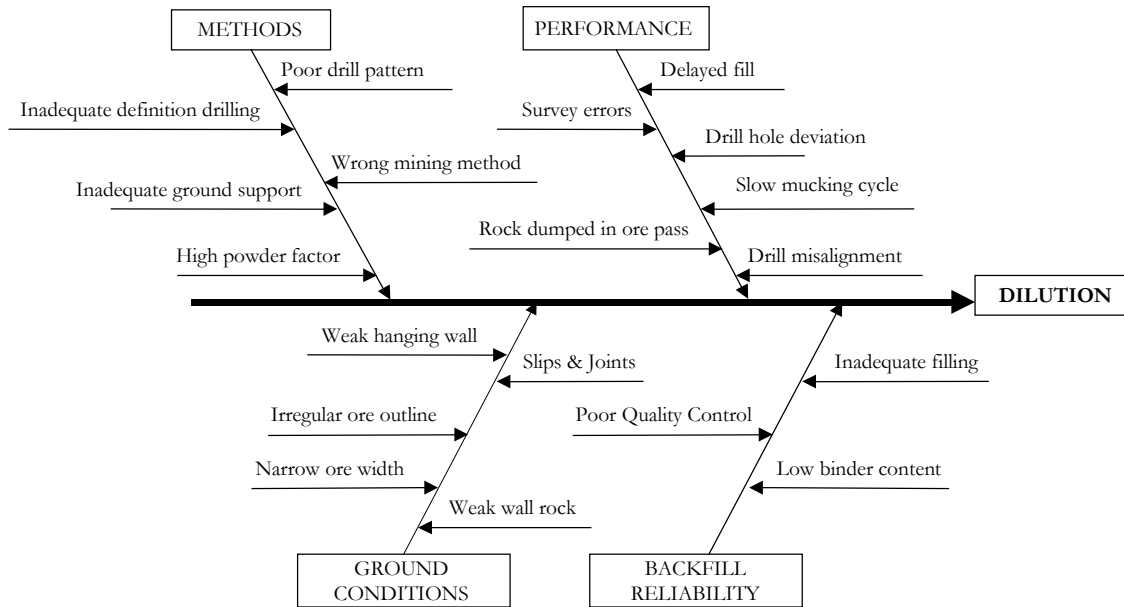

Figure 3-1 Fishbone Chart

3.6 Mine Planning

Once a mine is producing, a series of mine production schedules based on current reserves and proposed mining methods should be prepared and updated on a regular basis. These schedules form an integral part of the ongoing reconciliation that must be performed to monitor the success of the selected mining method. Most active mining operations in North America have the following production schedules readily available for review and audit by senior staff or consultants.

- Three month (updated every three months)
- Six month (updated every six months)
- One year (updated every year)
- Two year (updated every year)
- Five year (updated every two to three years)
- Ten year (updated every five years)

3.7 Mining Methods for Large Capacity Underground Mines

Table 3-1 Mining Methods for some of the World's largest Capacity Underground Mines

Company	Mine	Location	Capacity tons per day (tpd) ¹	Primary Mining Methods	Mineral	Mean Optg. Depth	Age of Operation (years)	Primary Ore Flow System to Surface	Primary Ore Transfer (from stope)	Comments
LKAB	Kiruna	Sweden	52,000	70% Sublevel Cave 22% Sublevel Stope	Fe	3,000 feet	30+	shafts	OP/rail	Recent expansion from 37,000 tpd.
MIM Holdings	Mount Isa	Australia	31,000	Sublevel Open Stoping	Zn, etc.	3,600 feet	70+	shafts		Electric Trucks, Remote LHDs.
Western Mining	Olympic Dam	Australia	20,000	Blasthole	Cu, U	2,000 feet	in expansion	shaft	OP/rail	New shaft planned for expansion.
JM Asbestos	Jeffrey	Canada (PQ)	20,000	Block Caving	Asbestos	2,000 feet	in construction	shaft	OP/rail	Under construction.
BHP (Magma)	San Manuel	USA (AZ)	68,000	Block Caving	Cu	2,500 feet	30	shafts	OP/conveyor	Peak production of 68,000 tpd obtained in 1972.
BHP (Magma)	Lower K	USA (AZ)	55,000	Block Caving	Cu	4,000 feet	5	shafts	OP/conveyor	Current production (same mine as above)
Confidential		USA (AZ)	60,000	Block Caving	Cu	5,000 feet	planning	shafts		Pre-feasibility stage.
Miami Copper Co.	Miami	USA (AZ)	20,400	Block Caving	Cu		historic	shafts		Closed for many years.
Phelps Dodge	Safford	USA (AZ)		Block Caving	Cu		historic	shafts		Mine built, but ore would not cave properly (blocky).
Phelps Dodge	Climax	USA (CO)	36,000	Block Caving	Mo	2,000 feet	70	adits	OP/rail	Closed 1986 (on standby)
Phelps Dodge	Henderson	USA (CO)	38,000	Block Caving	Mo	2,000 feet	10	tunnel	OP/rail	New level under development, LHDs to ore passes to rail.
Occidental Petroleum	Cathedral Bluffs	USA (CO)	60,000	Retort	Oil Shale	1,800 feet	historic	shafts		Built and commissioned, then immediately shut down and closed.

¹Capacity is reported in metric tons (tonnes) per day except for the USA (short tpd).

Table 3-1 Mining Methods for some of the World's largest Capacity Underground Mines (continued)

Company	Mine	Location	Capacity (tpd) ¹	Primary Mining Methods	Mineral	Mean Optg. Depth	Age of Operation (years)	Primary Ore Flow System to Surface	Primary Ore Transfer (from stope)	Comments
Copper Range	White Pine	USA (MI)	22,500	Room & Pillar	Cu	3,000 feet	historic	conveyor	LHD/truck	10 miles of underground conveyors.
Anaconda	Kelly	USA (MO)	25,000	Block Caving	Cu		historic	shafts		Closed for many years.
Noranda	Montanore	USA (MO)	20,000	Room & Pillar	Cu, Au	2,500 feet	on hold	conveyor	LHD/truck	Development stopped (environmental objections).
Molycorp	Questa	USA (NM)	16,300	Block Caving	Mo	4,000 feet	12	conveyor	LHD	Being prepared for re-opening.
Andes M.C. (Anaconda)	Portrerillos	Chile		Block Caving	Cu		historic	adits	OP/rail	Grizzlies to ore passes - 45 tons per manshift (1939).
Codelco	El Teniente	Chile	100,000	Block Caving	Cu	2,000 feet	100 a	adits	OP/rail	Everything used, including remote controlled LHDs.-
Codelco	El Salvador	Chile	34,500	Block Caving	Cu	2,000 feet	30 a	adits	OP/rail	LHD to ore passes to trains.
Codelco	Andina/Rio Blanco	Chile	15,000/45,000	Block Caving	Cu	2,000 feet	in expansion	adits	OP/rail	Being developed to increase to ±45,000. Mill is underground.
Codelco	Chuqui Norte	Chile	30,000	Block Caving	Cu	2,500 feet	planning			242 million tons @ 0.7% Cu (underground). (Planning stage.)
Freeport	Ertsberg East	Indonesia	17,000	Block Caving	Cu		15 a	ore passes	LHD/truck	Underground production varies (total production is 115,000 tpd).
Philex Minerals	Santo Thomas	Philippines	28,000	Block Caving	Cu	3,400 feet	20 a	adits	OP/rail	Going concern.
Atlas	Lutopal	Philippines	35,000	Block Caving	Cu	2,000 feet	historic	adits	OP/rail	Mined out.
Atlas	Carman	Philippines	40,000	Block Caving	Cu		planning	adits	OP/rail	Planning stage.
Lepanto	Far Southeast	Philippines	17,000	Blasthole	Au	5,000 feet	on hold	shafts	LHD/truck	Feasibility stage.
RTZ	Palabora	South Africa	60,000	Block Caving	Cu	4,000 feet	in construction	shafts	LHD/truck	Under construction – now considering 80,000 tpd.

¹ Capacity is reported in metric tons (tonnes) per day except for the USA (short tpd).

4.0 Mine Layout

4.1 Introduction

The classic procedure for designing a mine starts by determining the mining method(s) and probable optimum mining rate (discussed in other chapters). This chapter is principally devoted to the next step – determining initial mine layout or “conceptual mine design.” The procedure is also considered initial mine planning.

If the mining method is open pit, the layout starts with the basic design of the open pit itself. This includes pit layouts in intervals up to the final design (ultimate pit). With the pit established, the infrastructure is planned, including surface haul roads, stockpiles, dumps, tailings impoundment, utility corridors, and surface plant layout. The mine layout for an open pit mine might have to be modified if underground mining is contemplated when the pit is exhausted.

If the plan includes underground mining, planning starts with locating and sizing pre-production and on-going development requirements. The initial planning includes determining level intervals, haulage ways, primary access (shaft, ramp or adit), and other major entries. The design of major entries necessitates considering the requirements for ore handling, waste rock handling, primary ventilation circuit, backfill, transfer, materials handling, access for personnel, refuge stations, and escape route(s). Once the underground mine concept is established, the surface infrastructure is designed, including access roads, dumps, tailings impoundment, utility corridors, maintenance facilities, explosives storage, and surface plant layout.

While the procedures outlined above may appear to be sequential, they are actually iterative to the extent that the process can become tedious. The practical solution for this dilemma is to conduct the exercise employing short-cut methods based on the following activities.

- Comparisons
- Intuitive reasoning
- Rules of thumb
- Tricks of the trade

Comparisons

Comparisons refer to the study of comparable well-engineered projects. In some cases, the layout of another mine may be accepted as a starting model.

Intuitive Reasoning

Intuitive reasoning by the team participants is knowledge-based and relies on rational perception, first-hand mining experience, and good judgment.

Rules of Thumb

Rules of thumb may be applied to break circular references by providing benchmarks and starting points. Rules are also useful in identifying significant planning problems at an early stage.

Tricks of the Trade

Tricks of the trade are particular concepts and efficient procedures employed to save time and effort.

4.2 Rules of Thumb

Pit Layout

- The overall slope (including berms, access roads, and haul roads) of large open pits in good ground will eventually approach the natural angle of repose of broken wall rock (i.e. 38 degrees), except for the last few cuts, which may be steeper. *Source: Jack de la Vergne*
 - When hard laterites are mined in an open pit, safe pit slopes may be steeper than calculated by conventional practice (as steep as 50 degrees between haul roads). *Source: Companhia Vale do Rio Doce*
 - For haul roads in general, 10% is the maximum safe sustained grade. For particular conditions found at larger operations, the grade has often been determined at 8%. It is usually safe to exceed the maximum sustained grade over a short distance. *Source: USBM*
 - The maximum safe grade over a short distance is generally accepted to be 15%. It may be 12% at larger operations. *Source: Kaufman and Ault*
-

Pit Layout (continued)

- The maximum safe operating speed on a downhill grade is decreased by 2 km/h for each 1% increase in gradient. *Source:* Jack de la Vergne
- Each lane of travel should be wide enough to provide clearance left and right of the widest haul truck in use equal to half the width of the vehicle. For single lane traffic (one-way), the travel portion of the haul road is twice the width of the design vehicle. For double lane (two-way), the width of roadway required is 3½ times the width of the widest vehicle. *Source:* Association of American State Highway Officials (AASHO)
- To avoid a collision caused by spinout, the width of an open pit haul road should equal the width plus the length of the largest truck plus 15 feet safety distance. *Source:* Janet Flinn
- A crushed rock safety berm on a haulage road should be at least as high as the rolling radius of the vehicle tire. A boulder-faced berm should be of height approximately equal to the height of the tire of the haulage vehicle. *Source:* Kaufman and Ault

Crown Pillar

- A crown pillar of ore beneath the open pit is usually left in place while underground mining proceeds. The height of the crown pillar in good ground is typically made equal to the maximum width of stopes to be mined immediately beneath. When the overburden is too deep, the orebody is not mined by open pit, but a crown pillar is left in place of height the same as if it were. If the outcrop of the orebody is badly weathered (“oxidized”) or the orebody is cut by major faults, under a body of water or a muskeg swamp - the height of the crown pillar is increased to account for the increased risk. *Source:* Ron Hafliidson and others

Mine Entries

- Small sized deposits may be most economically served by ramp and truck haulage to a vertical depth of as much as 500m (1,600 feet). *Source:* Ernie Yuskiw
- A medium-sized deposit, say 4 million (short) tons, may be most economically served by ramp and truck haulage to a vertical depth of 250m (800 feet). *Source:* Ernie Yuskiw
- The optimum “changeover” depth from ramp haulage to shaft hoisting is 350m (1,150 feet). *Source:* Northcote and Barnes
- In good ground, at production rates less than one million tons per year, truck haulage on a decline (ramp) is a viable alternative to shaft hoisting to depths of at least 300m. *Source:* G.G. Northcote
- Western Australia practice suggests a depth of 500m or more may be the appropriate transition depth from decline (ramp) haulage to shaft hoisting. *Source:* McCarthy and Livingstone
- Production rates at operating mines were found to range from 38% to 89% of the estimated truck fleet capacity. For a proposed operation, 70% is considered to be a reasonable factor for adjusting theoretical estimates to allow for operating constraints. *Source:* McCarthy and Livingstone
- Shallow ore bodies mined at over 5,000 tpd are more economically served by belt conveyor transport in a decline entry than haul trucks in a ramp entry. *Source:* Al Fernie
- As a rule, a belt conveyor operation is more economical than rail or truck transport when the conveying distance exceeds one kilometer (3,281 feet). *Source:* Heinz Altoff

Shafts

- The normal location of the production shaft is near the center of gravity of the shape (in plan view) of the orebody, but offset by 200 feet or more. *Source:* Alan O’Hara
 - The first lift for a near vertical orebody should be approximately 2,000 feet. If the orebody outcrops, the shaft will then be approximately 2,500 feet deep to allow for gravity feed and crown pillar. If the outcrop is or is planned to be open cut, the measurement should be made from the top of the crown pillar. If the orebody does not outcrop, the measurement is taken from its apex. *Source:* Ron Hafliidson
 - The depth of shaft should allow access to 1,800 days mining of ore reserves. *Source:* Alan O’Hara
 - For a deep orebody, the production and ventilation shafts are sunk simultaneously and positioned within 100m or so of each other. *Source:* D.F.H. Graves
-

Underground Layout

- Footwall drifts for Blasthole mining should be offset from the ore by at least 15m (50 feet) in good ground. Deeper in the mine, the offset should be increased to 23m (75 feet) and for mining at great depth it should be not less than 30m (100 feet). *Source: Jack de la Vergne*
 - Ore passes should be spaced at intervals not exceeding 500 feet (and waste passes not more than 750 feet) along the footwall drift, when using LHD extraction. *Source: Jack de la Vergne*
 - The maximum economical tramming distance for a 5 cubic yard capacity LHD is 500 feet, for an 8 cubic yard LHD it is 800 feet. *Source: Len Kitchener*
 - The amount of pre-production stope development required to bring a mine into production is equal to that required for 125 days of mining. *Source: Alan O'Hara*
-

4.3 Tricks of the Trade

- Job one for mine layout of an open pit (and important for an underground mine) is to obtain aerial photographs and a resulting contour map of the mine area. In the long run, one is better off to get good topographical and survey controls right in the beginning. *Source: Richard Call*
- Outcrop ore bodies are traditionally open cut to the economic limit, after which mining may take place underground. For a steeply dipping orebody of uniform width, the optimal depth of the open cut is a function of the stripping ratio, which in turn approximates the ratio of underground to surface mining costs. It may be economical to increase the stripping ratio where waste rock is to be later employed underground as fill. *Various Sources*
- For a high grade orebody, outcropping or not, with well defined boundaries facilitating similar recoverable ore quantities by either open pit or underground methods and negligible quantities of lower grade ores, the current methodology is to establish the open pit operation switch to an underground operation on the basis of the operating costs (i.e. to the point where the cost of mining the last tonne and its associated stripping is equal to mining that tonne of ore underground). This is a very simple concept to apply. The reliance on operating costs leads to the rather elegant independence of the boundary of the underground development from commodity prices or target marginal costs of production, which, on the other hand, are necessary for establishing the limit of an open pit. *Source: Tim Koniaris*
- Haulage costs for open pit are at least 40% of the total mining costs; therefore, proximity of the waste dumps to the rim of the pit is of great importance. *Source: Frank Kaeschager*
- As a pit deepens, grade control and blending may become more difficult. This is one reason that proposed underground operations should be phased in at an early date. *Source: Unknown*
- The old rule that says a vertical shaft should be located 200 feet from the crest of an open pit has been proven invalid by sorry experience. The set back distance should be determined by rock mechanics. *Source: Jack de la Vergne*
- To design the optimum layout for a new underground mine, it is important to first determine the planned mining methods and stoping sequence. Conceptual engineering should be referenced first to the orebody. Mine layout serves the miners, it is not the other way around. *Source: Jack de la Vergne*
- Bad ground is traversed at less risk with a vertical shaft than a lateral or inclined heading. Where a choice must be made, a shaft should be located in the bad ground and the lateral access to the orebody in the good ground – not the other way around. *Source: Jack de la Vergne*
- In the case of a deep orebody, it has already been well proven that a twin shaft layout can be used to bring a new mine into a high rate of production at an early stage, which must be the aim of every new mining venture. Sinking two shafts simultaneously also provides desirable insurance against the possibility of one shaft encountering serious sinking difficulties. *Source: L.D. Browne*
- For deep mines with a natural rock temperature exceeding 100° F (38° C), the size and location of shafts should be determined mainly by ventilation considerations. *Source: Dr. J.T. McIntyre*
- A twin shaft layout (shafts close together) for a deep mine will require twin cross cuts to the orebody for an efficient ventilation circuit. It may be better to set the shafts far apart. *Source: Jozef Stachulak*
- Normally, the concentrator (mill) should be located close to the mine head. Pumping tailings from the mill is less expensive than truck hauling ore over a similar distance. When pumping water to the mill, hauling concentrate from the mill and use of a portion of the tailings for paste fill is also considered, the argument is even stronger. *Source: Edgar Köster*

- The mine administration offices should be located as near as possible to the mine head to reduce the area of disturbance, improve communications, and reduce transit time. *Source:* Brian Calver
- When a mine has a camp incorporated into its infrastructure, the campsite should be as close as practical to the mine to minimize the cost of service and utility lines, as well as to expedite emergency call-outs. *Source:* George Greer
- It is normally false logic to consider particular items of used plant and equipment at the conceptual design stage. The conceptual engineering should consider all new plant and equipment sized and built to provide optimum extraction and recovery. In this manner, a benchmark reference is provided against which opportunities to provide particular items of used plant and equipment may be later evaluated. *Source:* Jack de la Vergne

4.4 Strategy for Underground Mines

Ramp Haulage

For small ore bodies, ramp haulage is the default selection because it normally provides the most flexible and economical choice. (In a cordillera, the terrain may provide relief adequate for a level entry or “adit.”) A ramp (or adit) drive can typically be oriented to provide an underground diamond-drilling base and provide shorter crosscuts to the ore zone. The crosscuts are provided rapidly and economically because they provide a second heading for the main drive. It is possible to sink and develop from a shaft at the same time; however, this is a difficult and expensive procedure.

Another advantage to the ramp or adit entry is direct access by mobile equipment when trackless mining is to be employed. For a typical shaft, the equipment must be dismantled and reassembled underground. The set-up time required to initiate ramp driving is usually shorter than for a shaft. One to three months may be required to provide access and collar a ramp portal, while the collar, hoist, and headframe required for a shaft may take six months of site work.

For medium sized ore bodies, ramp haulage may still be the best choice where the orebody is relatively flat lying. In this case, the ramp may have to be enlarged to accommodate larger trucks. In some cases, it may be practical to provide twin ramp entries to handle two-way traffic.

Belt Conveyor

For large, flat-lying ore bodies, a belt conveyor is typically the most economical method of hoisting ore. The legs of the conveyor are put into a ramp that has been driven straight (i.e. a “decline”) for each leg of the proposed conveyor way.

If the soil overburden is very deep, or deep and water bearing, a ramp or decline may not be a practical method due to the extraordinary cost of excavating and constructing a portal. If the ground (bedrock) beneath the overburden is not competent or is heavily water bearing, a ramp or decline access may be impractical due to the driving time and cost.

Shaft System

For large steeply dipping ore bodies, a shaft system is usually best. In this scenario, it may be advisable to have a ramp entry as well to accelerate the pre-production schedule and later to provide service access to the mine.

Conventional Methods of Ore Transport

At the conceptual stage, it is normally better to consider only conventional methods for the transport of ore and resort to the unusual methods only under unusual circumstances. A good example of “unusual” is the aerial tramway installed across a fjord at the Black Angel Mine in Greenland to access an orebody located high on a cliff face.

Table 4-1 lists methods employed at underground mines for ore transport.

Table 4-1 Ore Transport Methods Employed at Underground Mines

Transport	Conventional	Unusual	Prototype
Vertical	Shaft	Vertical Conveyor	Pipeline, Airlift
Inclined	Conveyor, Truck	Shaft, Tramway	
Horizontal	Conveyor, Truck, Rail	Road Train, Slusher	Pipeline

The following flow chart (Figure 4-1) summarizes rules of thumb for bringing ore to surface from an underground mine.

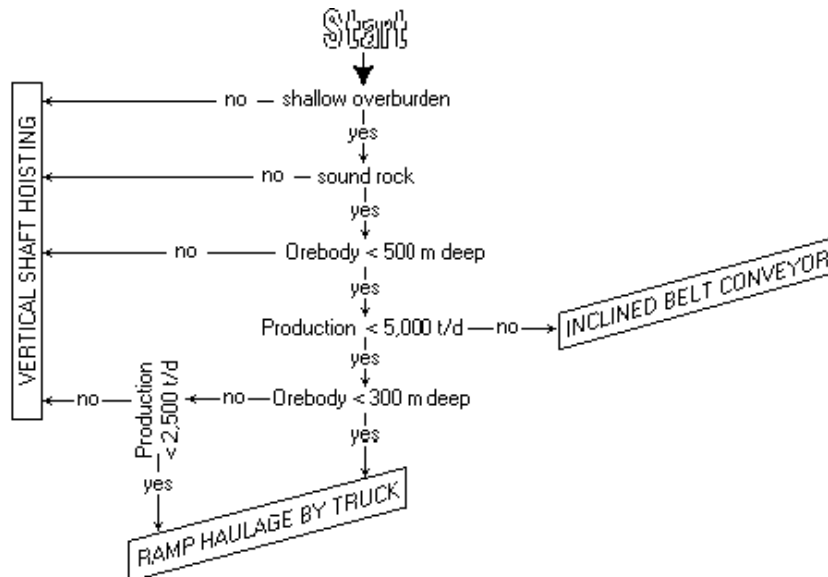

Figure 4-1 Moving Ore to Surface

While the chart is a good tool for preliminary analysis, it is only a rough guideline. It is not sufficient for final determination. In recent years, there have been a number of studies that attempt to better determine the optimum ore transport method, particularly with the option between ramp haulage and shaft hoisting. The first efforts were related to costs only. Later, it was assumed that there was a limiting factor to truck haulage based upon the amount of traffic a ramp entry can bear (queuing theory). Computer simulations carried out on this basis appear to indicate that traffic congestion is not likely to be the limiting factor.

In the meantime, some operators in Peru, Nevada, and Australia (unburdened by theoretical research) determined that truck haulage efficiency is enhanced when the motor horsepower is increased so that the truck can travel faster up the ramp. It is now considered that the limiting factor is ventilation because it is normally not practical to provide an air change in one leg of a ramp entry and there is a practical limit to the amount of fresh air that a ramp can carry. The limit is not determined by economics but by the air velocity that will entrain dust. The other important consideration is that if shaft development is delayed beyond a certain point, the remaining reserves may be sterilized if they are not sufficient to justify a shaft installation. It is reported that one underground mine in South America chased a vein-type orebody to a vertical depth of 700m by means of truck haulage at which point further mining was no longer economical and the mine was then abandoned.

Case History

Western Metals' Pillara Mine in Australia reports a daily production of 6,500 tonnes of ore with eight 50-tonne trucks over an average one-way haulage distance of 3.7 km. The 5.5m x 5.8m ramp has a total length of 4.1 km at a gradient of 7:1 (14.3%). The trucks were upgraded with 650 HP engines to enable a speed of 12 km per hour up the ramp.

Main Entry

The foregoing strategy determines a main entry to the underground on the basis of ore transport. In many cases, this entry also serves for personnel and materials transfer, particularly at small operations. Consideration should be given to a separate entry for man and materials handling when it can be afforded. For example, some mines use the production shaft for ore/waste hoisting, main exhaust, and alternate escape while a second shaft provides cage service in the main fresh air entry. If a shaft system is employed at an operation of substantial capacity, it is not uncommon to find a ramp access from surface as a third entry. This is a logical progression when an internal ramp system is required by the mining method to be employed. The access ramp has advantages described in previous text of this chapter.

5.0 Environmental Engineering

5.1 Introduction

“Environmental Mine Engineering” is traditionally involved with managing water and waste products to avoid pollution; however, the range of concerns is growing. Today it includes dust control, noise attenuation, recycling, reclamation, and reduction of visual impact. Tomorrow it may include macro-environmental (for example, global warming) and socio-economic considerations.

The interface between the miner and the environmentalist demands an exchange of knowledge and good communications. For this purpose, the miner must become versed in the basics of environmental engineering. The aim of this chapter is to aid this process.

The following endeavors are now generally considered to be within the domain of environmental engineering.

- Supply and purification of potable water.
- Supply, treatment, recycling, and disposal of process water.
- Treatment and discharge of mine water, gray water, and black water.
- Treatment and disposal of tailings.
- Stockpiling and replacement of overburden (soil).
- Disposal and treatment of waste rock.
- Control of airborne emissions, including dust.
- Erosion control.
- Diversion channels for storm water run-off and streams.
- Retention pockets for surface pipelines.
- Containment structures for fuel storage tanks.
- Noise attenuation.
- Reclamation and rehabilitation.

The text of this chapter is only a primer to a field of work that is far more extensive than can be adequately addressed in this handbook. Identifying and dealing with environmental concerns often involves complex procedures that are difficult to describe in simple terms. There are exceptions to be found to any general observation and the processes commonly employed are constantly changing due to technical advances and better-defined environmental considerations. As more stringent environmental regulations are enacted, the required engineering effort becomes more and more significant to hard rock mining. The emphasis should be on prevention rather than reacting after the fact. By anticipating future environmental considerations, environmental impact can be minimized, true costs optimized, and real blunders avoided.

The total environmental effort includes art, science, and engineering. Due to space limitations, this chapter is more or less confined to the engineering applications. Ventilation engineering (including dust control) is discussed separately in Chapter 18 – Ventilation.

5.2 Rules of Thumb

Environmental Impact Statement

- The cost of an environmental impact statement (EIS) (including base line monitoring and specific previously performed studies) may cost approximately 2.5% of the total pre-production capital cost for a plain vanilla domestic mining project. The cost can increase by 2% for an undertaking that is politically or environmentally sensitive. In the latter case, the cost may increase further if proposals are challenged in the courts. *Source:* R.W. Corkery

Site Layout

- If the mill (concentrator) is located close to the mine head, the environmental impact is reduced and so are the costs. Pumping tailings from the mill is cleaner, less disruptive to the terrain, and less expensive than to truck haul ore over a similar distance. When pumping water to the mill and hauling concentrate from the mill is considered, the argument is usually stronger. The rule is further reinforced in the case of an underground mine where a portion of the tailings is dedicated for paste fill or hydraulic fill. *Source:* Edgar Köster
 - The mine administration offices should be located as near as possible to the mine head to reduce the area of disturbance, improve communications, and reduce transit time. *Source:* Brian Calver
-

Site Layout (continued)

- When a mine has a camp incorporated into its infrastructure, the campsite should be as close as practical to the mine to minimize the impact from service and utility lines, decrease the area of the footprint of disturbance, shorten travel time, and reduce costs. *Source: George Greer*

Site Drainage and Spill Protection

- Drainage ditches to protect the mine plant should be designed to develop peak flow rates based on 100 year, 24 hour storm charts. *Source: AASHO*
- Dykes around tank farms should be designed to hold 100% of the capacity of the largest tank + 10% of the capacity of the remaining tanks. *Source: George Greer*

Water Supply

- If a drilled well is to be used for fire fighting without additional storage, it should demonstrate (by pumping test) a minimum capacity of 40 USGPM continuously for two hours during the driest period of the year. *Various Sources*
- Chlorine should be added to water at a rate of approximately 2 mg/litre to render it safe to drink. *Source: Ontario Ministry of Health and Welfare*

Dust Suppression

- Dust emissions emanating from the transport of ore will not remain airborne when the size of dust particle exceeds 10 μ (ten microns). *Source: Howard Goodfellow*
-

5.3 Tricks of the Trade

- Sub-aqueous deposition of potentially acid generating rock is recommended for nearly all applications, owing to the relative ease of design/construction, and the fact that such an impoundment may be built maintenance free, forever.
- Any surface concrete structure designed for a new mine (or added to an existing mine) should include plastic pipe inserts suitable for loading explosives in order to facilitate ultimate demolition. *Source: Peter R. Jones*
- Planted tree screens can provide noise abatement and a windshield for dust control. They may also provide a natural snow fence.
- Perimeter earth walls (berms) lessen visual impact and provide some measure of noise absorption.
- Gabions are an aesthetic means of providing slope stability and erosion control.
- Drainage ditches with a V-shaped cross section are satisfactory for nearly all applications. (Refer to Section 5.8.)
- Silt fences across ditches help prevent the dispersion of sediment into a natural water course.
- An underground shaft dump feeding a conveyor incline to the mill eliminates a major noise source and permits a shorter headframe. *Source: Jack O'Shaughnessy*
- Nylon poultry netting over cyanide-laden ponds prevent death to wayward waterfowl. The netting is conveniently supported with a used car tire laid flat on top of each pylon.
- Employing used truck tires to build retaining walls demonstrates that consideration has been given to recycling.
- Stocking fish in a finishing pond provides a natural indicator of purification. Salmonoids, such as trout, sink when they die so it is preferable to use a species of fish that will float providing immediate visual evidence of a problem.
- Drainage ditches for access roads should be designed to develop peak flow rates based on 10 year, 24 hour storm charts. *Source: AASHO*
- Open pits typically generate 2 to 5 tons of waste rock per ton of ore mined compared to about 0.25 tons of waste rock for an underground mine. *Source: Dirk van Zyl*
- In the Canadian Shield, the lower limit for acid generating potential can be as little as 0.2% sulfur in some volcanic waste rocks that contain minimal buffering capacity. In this extreme case, any rock with contents of higher than 0.2% sulfur would be classified as potentially acid generating and would be treated accordingly. *Source: George Greer*
- In the Canadian Shield, basic waste rock (with good buffering attributes) having a sulfur content greater than 0.5% should be considered to be potentially acid generating and treated accordingly. *Source: Tom Lamb*

5.4 Procedures

Environmental concerns are first encountered when applying for an exploration license. The license mandates certain environmental considerations be met or carried out during exploration activity and afterwards.

If the exploration proposal encompasses an extensive program, it may be wise to ensure that an underground entry is specified to avoid a second application should the results of the exploration work be promising and an exploration entry (shaft, ramp, or adit) become desirable.

“Base Line Studies” should be initiated as soon as possible once the exploration program indicates success. The base line studies are “Job One” because they must be completed before any change to the environment occurs and because they are a pre-requisite for subsequent efforts. The results of these studies will be the yardstick against which predicted and actual changes to the environment will be measured. The studies always include water monitoring and may include items such as inventories of flora and fauna, background radiation, identification of archeological sites, and a search for applicable hydrological, meteorological, and other previously published relevant data. In special circumstances, the tests may also include blood samples taken from wildlife and local residents to establish original toxicity levels (i.e. levels of mercury or lead). Background noise measurements may be conducted, where applicable. A weather station should be installed, including a means to measure temperatures, precipitation levels, precipitation pH, wind velocity, and natural dust fall (particularly for remote sites where historic data on climatic conditions is non-existent).

If and when the exploration program has advanced sufficiently to indicate that a viable mine may result, it is time to identify the “Major Environmental Constraints.” The list enumerated in the introduction may be used to help identify and categorize the areas of significant concern. From this effort, a short list must be developed and confirmed. It is most efficient to embark straightaway on special studies specifically addressing these concerns, especially when the studies require significant time. For example, a full year may be required to establish migratory patterns for caribou or polar bears. More time may be required to demonstrate that a migratory corridor near the project is wide enough to allow a slight narrowing. Two years or more may be required for complete field test plots to determine weathering kinetics of mine rocks.

A number of proposed mining projects have been aborted [Kitts-Michelin (Labrador), Windy Craggy (British Columbia), Montanore (Montana)] because a major environmental constraint could not be resolved. These misfortunes emphasize the importance of addressing environmental concerns early in the program.

5.5 Environmental Impact Statement

New mining projects anywhere in Canada or the USA (and elsewhere) are required by federal law to obtain approval based on an acceptable “Environmental Impact Statement.” Because this approval process may become the critical path to production, it is important to initiate its preparation as early as practical. Time can be saved if the pre-qualification process and selection of a firm to carry out the work has been completed before funds are available for its execution. More time can be saved if a detailed schedule of the work to be completed is formatted, agreed upon, and enforced. Managing EIS development is best served with fixed price or target price contracts. Straight cost reimbursable contracts (i.e. cost plus) with environmental consulting and legal firms may invite trivial pursuits adding to cost and time.

Environmental Impact Statement

The EIS (which incorporates previous studies) will describe the mine’s construction, operation, and closure, especially as related to the environment. It should clearly identify all areas of potential concern, provide a measure of the risks, and specify the planned remedies. The EIS is not complete without a “Management Plan” itemizing the procedure to monitor and control environmental concerns during the life of mine and thereafter. This plan will include terms of reference for “Annual Reports” devoted to environmental considerations and provisions for independent “Environmental Audits.”

Mine Closure Study

A Mine Closure Study will be included addressing rehabilitation. This study may identify the need to establish a topsoil stockpile at the outset, compost generating facility, and a nursery for indigenous trees and shrubs. A cost estimate for final rehabilitation may also be included to help determine the amount of the reclamation bond likely required to be posted by the mining company.

Case History

The pre-production cost for the environmental work at the recently completed \$700 million BHP Ekati Diamond Mine in the Northwest Territories of Canada was about \$14 million (2%), of which approximately \$4-5 million was in consulting fees over two years. *Source:* Canadian Mining Journal

5.6 Schedule

The following schedule (Table 5-1) provides a case study for the environmental process on two recent projects in Canada. The tabulation demonstrates that timelines can be significantly different for a large, politically sensitive project in a green field region than for a small operation proposed for a brown field project in an established mining district.

Table 5-1 Environmental Impact Statement Case Study

Major Green Field Project (Subject to Formal CEEA Review)		Small Project in Established Mining Region (Not Subject to Formal CEEA Review)	
<i>Description of Requirement</i>	<i>Duration (months)</i>	<i>Description of Requirement</i>	<i>Duration (months)</i>
Registration filed (company)	0	Prepare registration and file (company)	6
Federal-Provincial agreement to conduct joint environmental process	4	Review and accept or reject (government)	2
Prepare draft EIS guidelines (Panel)	1	Engineering and permitting (company)	8
Organize and conduct public "scoping" sessions (Panel)	3		
Revise and re-issue EIS guidelines (Panel)	1		
Prepare and submit EIS (company)	6		
Review EIS and comments from interviewers; assess adequacy of EIS and issue requests for additional information (Panel and interviewers)	3		
Additional information requests (Panel)	3		
Public hearings notice and conduct public hearings (Panel)	3		
Assess all information from hearings and develop recommendations (Panel)	3		
Total sequential time required	27		16

5.7 Acid Rock Determination

At the earliest possible date, a mine rock investigation should be initiated to assess the characteristics of mine grade ores, cut-off grade ores, and adjacent country rocks. Many sulfide-bearing rocks oxidize when exposed to the atmosphere. The products of oxidation include acids and metal compounds that may be harmful on surface and underground.

In certain cases, sulfide ores can cause significant problems. When broken, these ores can heat up significantly ("sinter") and even disintegrate if stored too long underground or on surface. Moreover, the gangue materials in these ores (which constitute the tailings from the mill) may not be suitable for disposal as backfill.

On surface, for an open pit operation the acid rock studies are desirable to determine the feasibility for "on land" disposal of waste rock and temporary stockpiling of low-grade ore.

For an underground mine, the first object of such a study is to assist in initial mine layout concepts. In this case, an attempt is made to confine mine entries and development layouts to areas where the waste rock generated is suitable for on-land disposal.

The second object for an underground mine is to determine in advance whether mine water will be acidic and to what degree. Most underground mines that have sulfide ores not buffered by basic country rock will generate acid mine water with a pH of between 2 and 5. Acid waters pumped to surface require treatment to modify the pH before being released to a natural watershed or recycled as process water for the mill. The neutralization is most often accomplished with the addition of lime (CaO). This neutralization is rarely carried out underground. Instead, the lime is added on surface, usually at a primary sedimentation pond that may bring the pH up to 8 or 9 to initiate precipitation of unwanted metals. At the entrance to a secondary ("polishing") pond, the water may be dosed with a flocculating agent (alum or polyelectrolyte) and more lime added to complete the precipitation of undesirable solids. If the water is to be subsequently released to the natural environment, it may require the addition of acid to reduce the pH to a mandated level. The actual process for any particular mine may vary from the simplified procedure described above.

Table 5-2 provides the pH levels at which the precipitation of common metal ions is optimized.

Table 5-2 Precipitation of Common Metal Ions

Metal Ion	Fe ⁺³	Cu	Zn	Pb	Ni	Fe ⁺²	Cd
Optimum pH	7.6	8.9	9.2	9.3	10.2	10.5	11.1

The use of proprietary reagents enables efficient precipitation at a lower pH value than is indicated in the table above.

In recent years, a tremendous amount of research has been completed on treating acid mine drainage from operating and abandoned mines. One of the most promising (Thiopaq®) has been installed at 16 minesites worldwide. The Thiopaq process uses elemental sulfur to turn fugitive metals into sulfides that are recovered to produce a commercial concentrate. Revenue from sale of concentrates, reduction of lime consumption, and less sludge generation makes this process very attractive.

5.8 Drainage Ditches and Culverts

Listed below are general rules for ditch construction.

- Ditches with a V-shaped cross section are considered the standard design.
- Ditch side slopes should be no steeper than 2:1, except when excavated in sound rock.
- Ditches should not be constructed at a gradient of less than 0.3% if they are not lined (or 0.2% if smooth-lined) so that the velocity of the water will be self-scouring.
- Ditches running at a gradient of 3% or less may be constructed without benefit of a liner, except in easily eroded material such as fine sand or silt.
- Ditches at a gradient between 3% and 5% should be seeded and protected with a geo-textile mesh to establish a grass lining. Alternatively, the ditch flow can be temporarily diverted (i.e. in a light plastic drainage pipe) until the grass is firmly established.
- For gradients exceeding 5%, the lining should consist of rocks placed on top of a geo-textile membrane. This lining should extend to at least 150mm (6 inches) above the computed elevation of maximum flow.

Flow Capacity

Table 5-3 provides the flow capacity in cubic feet per second of a standard ditch design (2:1 Vee) for different gradients and depths of water.

Table 5-3 Flow Capacity

Water Depth (feet)	Gradient (slope) %											
	1	2	3	4	5	6	7	8	9	10	11	12
	Grass						Rocks (cobble)					
0.2	0.1	0.2	0.2	0.2	0.2	0.1	0.2	0.2	0.2	0.2	0.2	0.2
0.4	0.8	0.9	1.1	1.3	1.5	1.0	1.0	1.1	1.2	1.2	1.3	1.4
0.6	2.3	2.8	3.3	3.8	4.3	2.8	3.0	3.3	3.4	3.6	3.8	4.0
0.8	4.9	6.0	7.1	8.2	9.2	6.1	6.5	7.0	7.4	7.8	8.2	8.6
1.0	9.0	10.7	12.9	14.9	16.7	11.0	11.8	12.7	13.4	14.2	14.9	15.5
1.2	14.5	17.6	21.0	24.2	27.1	17.8	19.2	20.6	21.8	23.0	24.1	25.2
1.4	21.9	26.0	31.6	36.5	40.9	26.9	29.0	31.0	32.9	34.7	36.4	38.0
1.6	31.3	38.2	45.1	52.1	58.3	38.3	41.4	44.2	46.9	49.5	51.9	54.2
1.8	42.8	52.5	61.8	71.3	79.7	52.4	56.6	60.5	64.2	67.7	71.0	74.1
2.0	56.6	70.1	81.7	94.4	106	69.4	74.9	80.1	84.9	89.5	93.9	98.1

Culvert Capacity

Ditches require culverts at road and rail crossings. The culverts should have capacity at least equal to that of the ditch. In temperate climates, no culvert should have a diameter of less than 300mm (12 inches). For main access roads, haulage roads, and railroads, no culvert should be placed with a diameter less than 450mm (18 inches).

Table 5-4 provides the entrance capacity in cubic feet per second for culverts flowing full without water backed up at the entrance to the culvert, as well as backed up in intervals of two feet of head over the top of the culvert at its entrance.

Table 5-4 Culvert Entrance Capacity

Culvert Diameter (inches)	Head of Water Over Top of Culvert Entrance (feet)			
	0	2	4	6
12	3.2	6.1	12	
18	6.3	12.5	23	
24	12	32	45	57
30	24	51	68	86
36	35	76	100	135
48	71	135	175	210
60	120	215	275	335
72	200	325	410	
84	275	445	600	
96	410	700		

5.9 Water Demand

Table 5-5 shows water demand at various mine facilities.

Table 5-5 Water Demand

Mine Facility	US gal/day	liters/day	USGPM	L/s
Mine camp (per miner)	50	190	-	-
Mine kitchen/cafeteria (per meal)	3	11	-	-
Mine dry (per miner)	30	115	-	-
Underground mine ¹ (per tonne/day)	1	1	-	-
Mill ² (per tonne ore/day)	2	2	-	-
Shower	-	-	5	19

¹ Refer to Chapter 25, Mine Dewatering

² Refer to Chapter 26, Mineral Processing

5.10 Chlorination of Potable Water

For batch chlorination, Table 5-6 may be used to determine chlorination quantities.

Table 5-6 Chlorination Quantities

Water Quantity (Imperial gallons)	3% Solution (standard)	5 ¼% Solution (Javex ¹)	12% Solution (industrial ²)
1	6 drops	3 drops	2 drops
3	19 drops	11 drops	6 drops
16	1 tsp.	0.5 tsp.	0.5 tsp.
50	0.5 oz.	0.3 oz.	0.2 oz.
100	1.1 oz.	0.6 oz.	0.4 oz.
250	2.7 oz.	1.5 oz.	0.9 oz.
500	5.3 oz.	3.0 oz.	1.7oz.
1,000	10.7 oz.	6.1 oz.	3.5 oz.

¹ Laundry bleach such as Javex, Chlorox, Perfex, etc.

² A 12% solution is sold by commercial suppliers in 5-gallon carboys

For prospecting, exploration, and development projects, the mixing is done in batches and chlorine is typically provided in solution (one gallon plastic bottles of bleach or five-gallon carboys). The chlorine solution must be well mixed with the water. If water is being pumped into a tank, the chlorine may be added during the pumping to allow the action of the incoming water to provide sufficient turbulence for adequate mixing. In the case where water is hauled in tanks, the movement in trucking the water to the site provides mixing. A contact time of minimum 20 minutes is required for the chlorine to be effective. In the case of haulage tanks, this is generally provided in traveling.

For permanent minesites and associated small town sites, the least expensive source of chlorine solution is made from powdered HTH ("high test hypochlorite", calcium hypochlorite), which has 70% available chlorine. A 3% solution is made by dissolving the HTH powder in water (preferably with a mechanical agitator). The 3% solution is fed to the water supply with a hypochlorinator. The only reliable hypochlorinator is one that is both electrically driven and has positive displacement. The water pump and hypochlorinator must be electrically interconnected to automatically operate simultaneously.

5.11 Recycling Mine Water

Traditionally, recycling mine water was confined to providing process water for the underground. No mill desires contaminants, such as nitrates (from explosives) or hydrocarbons (from spilled fuel, spilled lubricants, and waste oil from engine oil changes) in their process water.

Today, better measures are taken by mine operators to reduce this contamination at the source. When it is practical, using mine water as process water can be advantageous because it reduces the total volume of water to be discharged to the environment. Also, if mine water is combined with process water discharged from the mill, the water treatment costs may be reduced because of the pH of the mill water and the reagents it contains may react positively with pollutants in the mine water.

5.12 Smelter Emissions

Listed below are base case smelter emissions of SO₂ (approximate quantities emitted without benefit of scrubbers or flash furnace technology).

- Copper 625 kg/tonne of concentrate (1,250 Lbs./ton of concentrate)
- Lead 330 kg/tonne of concentrate (660 Lbs./ton of concentrate)
- Zinc 265 kg/tonne of concentrate (530 Lbs./ton of concentrate)

5.13 Cyanide

In recent years, several proposed gold mining projects in North America and Europe were turned down by their respective authorities as a result of concerns about the transport, storage, and use of cyanide. Unfortunately, no good substitute exists for this controversial reagent. A further concern is the destruction of waste cyanide (in weak solutions). This may be accomplished with one of five different proven methods (sulfur dioxide treatment, hydrogen peroxide treatment, chlorination, iron precipitation, or biological treatment). Cyanide destruction is further dealt with in Chapter 26 – Mineral Processing.

Note

Stantec wishes to gratefully acknowledge the assistance given by Mr. George Greer, former senior employee of the Voisey's Bay Nickel Company, who provided a significant amount of data, a portion of which is found in the main text of this chapter.

6.0 Feasibility Studies

6.1 Introduction

A feasibility study is an evaluation of a proposed project to determine whether and how it can be mined economically. Detailed Feasibility Studies extend the evaluation to determine the maximum profit or most secure profit to be obtained and provide a blue print for implementation. Three types of feasibility studies are described in the following paragraphs; however, the remainder of this chapter is mainly devoted to the preparation, execution, and appraisal of the Detailed Feasibility Study. The financial evaluations incorporated into feasibility studies are pursued separately in Chapter 7 – Mineral Economics.

Order-of-Magnitude

Order-of-Magnitude Feasibility Studies constitute an initial financial appraisal and are often carried out by a single individual. To be effective, this study should include an elementary mine plan. Order-of-Magnitude Studies may evaluate whether to initiate or proceed further with an exploration project that has an indicated mineral resource. When an underground entry (shaft or ramp) is required to complete an exploration program, this type of study is employed to determine the benefit to (and possible interference with) subsequent permanent entries. Order-of-Magnitude Studies are accurate to $\pm 40\text{-}50\%$ and are usually obtained by copying mine layouts and factoring known costs and capacities of similar projects completed elsewhere.

Preliminary Feasibility

Preliminary Feasibility or "Pre-feasibility" Studies are the second order and are useful in the following cases.

- Due diligence work
- Determining whether to proceed with a Detailed Feasibility Study
- A "reality check" on detailed estimates to pin point areas meriting further attention

Preliminary Studies are accurate to $\pm 25\text{-}30\%$ and are typically obtained by factoring known unit costs and estimated gross dimensions or quantities once conceptual or preliminary engineering has been completed. Preliminary Studies are usually completed by a small group of multi-disciplined technical people.

Detailed Feasibility

Detailed Feasibility Studies are normally the highest order and most important because they are the litmus test for proceeding with a project. Typically, Detailed Studies are the basis for capital appropriation and provide the budget figures for the project. They may be completed with a financial accuracy of $\pm 10\%$ provided that a significant portion of the formal engineering is completed. In some cases, Detailed Studies are completed to an accuracy of $\pm 15\%$ with quantities derived from general arrangement drawings only. When the engineering is later sufficiently advanced, a second estimate is made to an accuracy of $\pm 10\%$ to provide confirmation and firm budget numbers.

6.2 Rules of Thumb

Cost

- The cost of a Detailed Feasibility Study will be in a range from $\frac{1}{2}\%$ to $1\frac{1}{2}\%$ of the total estimated project cost. *Source: Frohling and Lewis*
- The cost of a detailed or "bankable" feasibility study is typically in the range of 2% to 5% of the project, if the costs of additional (in-fill) drilling, assaying, metallurgical testing, geotechnical investigations, environmental scrutiny, etc. are added to the direct and indirect costs of the study itself. *Source: R. S. Frew*

Time

- The definitive feasibility study for a small, simple mining project may be completed in as little as 6-8 weeks. For a medium-sized venture it may take 3-4 months, and a large mining project will take 6-9 months. A world-scale mining project may require more than one year. *Source: Bob Rappolt and Mike Gray*

Accuracy

- $\pm 15\%$ accuracy of capital costs in a Detailed Feasibility Study may be obtained with 15% of the formal engineering completed; $\pm 10\%$ accuracy with 50% completed and $\pm 5\%$ accuracy may be obtained only after formal engineering is complete. *Source: Frohling, Lewis and others*
-

Production Rate

- The production rate (scale of operations) proposed in a feasibility study should be approximately equal to that given by applying Taylor's Law. (Refer to Section 6.6)

- Annual production should be one-third of the tons per vertical foot times 365 days in a year for a steeply dipping orebody. *Source:* Ron Cook

- In the case of an orebody that is more or less vertical, the daily tonnage rate may approximate 15% of the tonnes indicated or developed per vertical meter of depth. *Source:* Northern Miner Press

- At many mines, the annual production is equal to 30 vertical meters of ore. Others vary between 25 and 40m. *Source:* Wayne Romer

- For a steeply dipping orebody, annual production should not exceed 30 to 40m of mine depth. *Source:* Robin Oram

- For a steeply dipping orebody, the production rate should not exceed 60m (vertical) for a small mine. At mines producing over two million tons per year, 30-35m per year represents observed practice. *Source:* McCarthy and Tatman

Development

- Preproduction development should be six months ahead of production. *Source:* METSInfo

 - Six months of production ore should be accessible at all times to ensure stope scheduling and blending. *Source:* Kirk Rodgers
-

6.3 Tricks of the Trade

- Due diligent appraisal of a feasibility study should not neglect to consider whether the future of those individuals who sanctioned its approval is enhanced by a project go ahead, especially when excessive optimism is expressed. *Source:* Dennis Arrouet
- The pre-production capital cost should not include sunk costs already paid or committed, whether or not the project proceeds. *Source:* Roland Parks
- A conservative estimate for the capital cost can make heroes of the mine builders while one that is under-estimated can lead to unforeseen problems when ill advised short-cuts are taken to overcome a budget deficiency. *Source:* Jim Ashcroft
- The capital cost estimate of a Detailed Feasibility Study should normally consider all new plant and equipment sized and built to provide optimum extraction and recovery. In this manner, a benchmark reference is provided. Opportunities to provide particular items of used plant and equipment may be compared to the benchmark and included as a side study. When feasibility is dependent upon the incorporation of second hand components to meet a financial hurdle, certification should be provided that the components will still be available at the time of building. *Source:* Jack de la Vergne
- Capitalized interest during construction is often left out or underestimated in the capital cost estimate. It must be included as it may be a large number. *Source:* Ronald J. Vance
- The rate of return on investment predicted in a feasibility study may have been distorted by the application of accumulated debt to lower the rate of taxation. *Source:* L.D. Smith
- The cash flow (and hence the rate of return on investment) predicted in a feasibility study will be altered favorably if leasing instead of purchasing the equipment fleet is contemplated. (This procedure is an example of employing "hidden" leverage.) *Source:* Jack de la Vergne
- A mine in the arctic is required to store the concentrate during the long winter. This is a major detriment to the cash flow and the rate of return on investment, unless the concentrate is sold forward to the smelter before shipment. *Source:* Hank Giegerich
- A "straight-line" financial analysis in constant dollars (escalates neither revenue nor costs and all capital is depreciated on a straight-line basis for the life of the project with no salvage value or closure cost) is a reliable economic appraisal, particularly in times of high inflation. *Source:* George Beals
- A "bare bones" financial analysis (current dollars, no inflation, no interest on debt, and no tax reduction) provides a base case for project evaluation (and a means to better compare alternate investment opportunities). If a project shows itself well under these "bare bones" circumstances, it should show itself well under any real circumstance. *Source:* L.D. Smith

- Even a “straight line” or “bare bones” financial appraisal may be distorted if a long pre-production schedule is significantly underestimated. It often happens that the schedule does not take proper account of the long period between production initiation and the time that the mine eventually reaches full production capacity with grade control measures fully developed and implemented. *Source:* Jack de la Vergne
- If the estimated mining cost per pound of metal is at or below that of low-cost producers, the accuracy of forward projection of metal prices becomes relatively less important. *Source:* Roland Parks
- Mines are price takers, not price setters – and metal markets are not predictable. The process of financial optimization is traditionally directed towards achieving maximum return on investment, based on presumed metal prices. This measure is not foolproof. Perhaps a better approach is to direct first efforts towards producing the metal at a lower cost than most other mines, thereby reducing the risk for all the stakeholders. This consideration may involve raising the cut-off grade and selective extraction. *Sources:* Frank Kaeschager, Warren Buffet, and others

6.4 Order-of-Magnitude Feasibility Estimate

The Order-of-Magnitude Study first requires an estimate of the value of ore in the ground. A geological report provides the necessary information on the grade and quantity of ore that has been identified. Current metal prices (normally quoted in US dollars) may be applied to these values to determine a gross value to which a factor must be applied to obtain the net value of the ore. Only for the purpose of determining this factor, dilution from mining may be assumed at 15%. (In practice, dilution may vary widely.) Likewise, mill recoveries can be assumed at 90% for gold; 85% for lead, copper, or nickel; 80% for silver; and 75% for zinc. (In practice, mill recoveries may vary from these norms.) Smelter and/or refinery returns can be estimated at 95% for doré (gold and silver bullion) and for separated concentrates: 85% for contained gold, 75% for contained silver, 90% for copper, 85% for lead or nickel, and 75% for zinc. These assumptions lead to the overall reduction factors (rounded off) shown in Table 6-1.

Table 6-1 Metal Reduction Factors

Metal	Reduction Factor	Metal	Reduction Factor
Gold (doré)	75%	Copper	60%
Gold in concentrate	60%	Lead	55%
Silver (doré)	50%	Nickel	55%
Silver in concentrate	45%	Zinc	45%

(Unless a smelter/refinery is nearby, an additional 5% may be deducted from each factor, to account for transport of concentrate.)

For example, if a mineral resource contains an assayed grade of 8% copper (and no other minerals are present), the net value of one short ton at an assumed market price of US\$1.00 /Lb. is simply calculated:

$$2,000 \times 0.08 \times \$1 \times 0.60 = \text{US\$96/ton}$$

For a polymetallic orebody, the easiest way is to convert the values of the minor constituents to equivalent value of the major and add it to that value (in US dollars). For example, if there are minor quantities of gold and silver associated with copper, an equivalent copper grade is calculated and the estimating procedure is then the same as if it were copper alone.

If the value per ton thus calculated is more than twice the estimated operating costs (mine, mill, and administration costs), then it may be profitable to build a mine.

Operating costs for hard rock mines may vary between US\$5 and US\$100/ton depending mainly on the scale of operations and the mining method employed. A quick estimate of the applicable operating costs may be calculated by obtaining actual costs from the published annual reports of mining companies with a similar orebody.

The operating cost procedure may also be employed as a diagnostic tool to indicate the presence of a “fatal flaw” (real blunder) when scrutinizing a more detailed feasibility report prepared by another party.

Some mining institutions that perform mineral economic studies on a routine basis have developed even simpler routines to obtain “quick and dirty” answers. A few others, less experienced, have made the error of using existing operations as a benchmark to determine viability. Erroneous conclusions may result from comparing ore grades of a proposed mine with those now profitably mined by a long-time producer, the capital cost of which has long been retired (amortized).

It should be emphasized that this (order-of- magnitude) evaluation procedure concerns only grades and recovery. It does not provide assessment of whether sufficient reserves exist to be economical.

6.5 Preliminary Feasibility Study

The Preliminary Study is most often completed in anticipation of a subsequent Detailed Feasibility Study. A Preliminary Feasibility Study is used to determine whether the major expenditure required for a comprehensive appraisal is warranted. Although it is carried out in the same manner as a Detailed Feasibility Study, the mine planning and depth of analysis are cursory by comparison. A Preliminary Feasibility Study is often completed in a few weeks; however, in some cases it represents a significant effort that may take two to three months.

The degree of scrutiny provided by a “due diligence” assessment is normally limited to the level of accuracy of a Preliminary Feasibility Study because of time constraints.

One typical result is a recommendation to proceed with a detailed feasibility *after* ore reserves are better defined. A Preliminary Feasibility Study culminates in the issue of a report that typically includes the following sections.

- Introduction and scope of work
- Summary and Conclusions
- Location and description of the project
- Map with inset and site plan
- Regional and local geology
- Description of mineralization
- Ore resource estimate
- Mine longitudinal drawing
- Typical mine sections and level plans
- Mining method(s) and sequence of extraction
- Ore transport
- Process plant
- Mill flow sheet
- Mine infrastructure and utilities
- Pre-production construction schedule
- Production schedule
- Capital cost estimate
- Operating cost estimate
- Preliminary financial evaluation

6.6 Detailed Feasibility Study

The Detailed Feasibility Study is the most important and often termed the Final Feasibility Study. The main goal is to prove (or disprove) the economic and practical viability of a proposed mining project. The Detailed Feasibility Study is the principal document required to secure funding and it provides a basis for construction planning and cost control.

“The purpose of a Detailed Feasibility Study is to clearly define a project and confirm (or deny) its economic viability. Even when a mine project is to be financed internally (i.e. without a project loan) by a mining company, a formal feasibility study should be undertaken, if for no other reason than to force the stakeholders to identify and think through all the problems involved. The feasibility study should confirm that the project would be completed to meet technical specifications and environmental stipulations at the estimated cost. The study should include an economic projection that forecasts production, operating costs, metal flow, and cash flow generated for the life of the project, as well as annual coverage for repayment of project loans (if applicable). A well-recognized and independent engineering firm should prepare the study. If, instead, it is completed in-house, the study should at least be checked independently and verified by comparison with similar projects, recently completed.”

G.R. Castle, *Project Financing Guidelines for the Commercial Banker*

Economic Projection

In addition to previously mentioned inclusions, the economic projection will not be complete unless it accounts for the following components.

- Applicable on-going capital costs
- Working capital requirements
- Insurance
- Royalties
- Depreciation/amortization
- Depletion
- Investment tax credits
- Processing allowance
- Forward sales
- Income taxes payable (federal, provincial/state and municipal)
- Corporate taxes
- Interest charges
- Freight
- Smelting and refining charges
- Mine closure
- Reclamation costs/bonds
- Risk and variance (sensitivity) analyses
- Exchange rates, currency contracts, etc.
- Currency exchange rates, currency contracts, etc. (foreign projects)

Practical Projection

The practical projection provides judgment on the following project components.

- Merit of the mine plan
- Method of processing ore
- Economic projection
- Permitting
- Stockpiling
- Marketing
- Management qualifications
- Labor pool
- Job training
- Recreation
- Social programs
- Employee housing
- Transportation
- Impact on adjacent communities
- Roads
- Water ways
- Ground water
- Wildlife management (in some cases)
- Archeological issues (in some cases)
- Aboriginal rights (in some cases)

Final Report

Preparation of a Detailed Feasibility Study culminates in a comprehensive report that may comprise a number of volumes.

- Volume 1 Summary Report
- Volume 2 Geology and Ore Reserves
- Volume 3 Mine Planning
- Volume 4 Mine Plant
- Volume 5 Mineral Processing
- Volume 6 Consultants' Reports
- Volume 7 Side Studies
- Volume 8 Quotations and Proposals
- Volume 9 Cost Estimates

Major Aspects

Some significant aspects of a feasibility study are dealt with in the following paragraphs.

- Feasibility Study Preparation
- Determination of Production Capacity
- Risk Analysis
- Mine Manning
- Preparation of Side Studies

Feasibility Study Preparation

Following are recommendations for preparing a Detailed Feasibility Study. (Source: Jim Redpath and others.)

- **Do** appoint one individual to be responsible for the feasibility study preparation (not a committee).
- **Do** provide this individual authority to match the responsibility.
- **Do not** burden the individual with additional assignments or responsibilities.
- **Do** appoint a deputy or second-in-command who can assume responsibilities if and when necessary.
- **Do not** skimp on conceptual engineering efforts at the outset of the study. This is the stage where true cost savings can be affected and fatal flaws avoided.
- **Do** consider alternatives and be receptive to innovation.
- **Do not** study alternatives to death or make the project viability subject to possible failure of prototype systems, equipment, or process.
- **Do not** invent a new format for the presentation of the study.
- **Do** use a tried and true structure that others can readily follow and comprehend. If possible, obtain a previous study for a similar project to use as a model.
- **Do** examine the project for *fast-track* potential. Detailed engineering performed concurrently with construction can shorten the overall schedule.
- **Do not** plan on temporary facilities if the permanent facilities (such as a headframe or hoist) can be made available on time.
- **Do** investigate the opportunities to place firm orders for major items of long delivery time before the green light is given. Such orders typically have a cancellation clause with a modest penalty in case the project fails to proceed.
- **Do** anticipate a learning curve at the start of mine development and plan for lower performance at start-up of production.
- **Do** add a contingency to both costs and schedule.
- **Do** calculate the contingency by determining the causes, potential consequences, and the chances for each to materialize.
- **Do not** be satisfied with the capital expense (capex) estimates until you are certain that no item of significant cost has been omitted or forgotten (bonds, taxes, duties, insurance, etc.).
- **Do** be suspicious of the operating expense (opex) estimates if they are significantly different from those actually experienced at similar operations elsewhere, measured on the same basis.
- **Do not** be satisfied with a project schedule until the chances of shortening the schedule are equal to the chances of finishing late.
- **Do** plan ahead, assuming acceptance and approval of the feasibility study. Remember that once the green light is given, the clock starts ticking.

Determination of Production Capacity

One of the important functions of a feasibility study is the determination of a scale of operations to maximize return on investment.

In the first instance, production capacity may be determined by applying one or more rule of thumb formulae. One of these, Taylor's Law, has proven surprisingly accurate for both open pit and underground application. It is used in preliminary evaluations and as a check on rates determined by rational analysis. Taylor's Law expresses the desired capacity as a function of ore reserve quantity.

Taylor's Law (Taylor, H.K. Rates of Working of Mines - A Simple Rule of Thumb, IMM Transactions, Oct, 1986)

The optimum extraction rate = $5 \times (\text{expected reserves})^{3/4} / (\text{days per year})$

In which "Expected reserves" are generally interpreted to mean *proven + probable* reserves.

Example

- Facts:
1. Expected reserves = 3,500,000 short tons
 2. Mine five days per week = 250 days/year
 3. Mill seven days per week = 350 days/year

- Solution: 1. Mining rate = 1,618 short tpd
 2. Milling rate = 1,156 short tpd

A second rule of thumb formula that was more recently reported involves regression analysis. The formula is based on actual production rates at existing mines. Since the database does not include those mines that have closed prematurely, it gives a result on the low side even if a significant portion of the possible reserves are considered in the determination of the predicted reserves.

Regression Analysis Formula (Mosher, et al)

The extraction rate = $200 (\text{predicted reserves})^{1/2} / (\text{days per year})$

A third rule of thumb that applies to steeply dipping ore bodies has recently become the subject of great interest. The rule appears in various forms, all of which have roots to one proposed by Herbert Hoover in 1909. His book, entitled "Principles of Mining," stated that one mining level per year was a good guide for planning purposes. Over the years, as the level interval increased, so did the rule of thumb. At a time, when the typical level interval became 150 feet, Professor Rice of the University of Toronto proposed that 6 inches per day (approximately 150 vertical feet per year) was a good rule and this guideline was widely accepted for many years. This rule had a good basis when the requirement for on-going development and stoping schedules, etc. was taken into account.

More recently, studies completed in Australia (McCarthy and Tatman) proposed that there is a cap on the rate of vertical extraction, and that if the cap is exceeded, "mine failure" will occur within a few years. The *Mining Journal* issue of May 7, 1999 reported that 60m (200 feet) per year is the practical upper limit for smaller mines. However, it was observed that practice at mines of 2 Mt/y or more was only 30-35m/year. The article went on to explain that the mode of failure was collapse of production due to the inability to maintain the "pace of infrastructure development." In this regard, it is interesting to note exceptions to the rule at two smaller mines. LKAB's Indian orebody Sweden was successfully mined at a rate of nearly 90m per year and the Beliveau mine in Canada was mined to exhaustion at a sustained rate of 104 vertical meters per year.

In preparing a Detailed Feasibility Study, a financial analyst will normally perform a rational analysis for the optimum economic rate of extraction. Results from a sensitivity study (refer to Chapter 7 – Mineral Economics) are typically plotted to obtain a graph that defines the optimum economical rate of production. The graph plots a series of production rates against a calculated benefit that may be expressed in terms of either payback period, rate of return, or net present value (NPV). Of these, the rate of return is likely the truest parameter since the NPV is normally based upon an arbitrary discount rate and maximum payback, and occurs (theoretically) if the orebody is mined out overnight!

In most cases, the optimum economical extraction rate is the one employed in the Detailed Feasibility Study. However, it sometimes happens that the scale of operations must be revised for reasons not concerning the project itself. The determination is referred to as sub-optimization and may occur for any one of the following reasons.

- Funds are not available or cannot be raised to build a mine at the optimum rate and so a smaller rate of production must be contemplated at the outset. (Numerous examples exist.)
- Mine production is significant enough to affect the global supply/demand balance for the primary metal produced and so a smaller rate of production must be assigned (e.g. Black Mountain Lead Mine in Africa).
- The reserves are so vast that it is not practical to mine at the rate that is theoretically calculated due to limitations on logistics and/or size of administration and management that would be required (e.g. P.T. Freeport Indonesia in Irian Jaya).
- The ore from two or more mines is to be treated at a central mill requiring consideration of mill capacity and optimum ore blend (e.g. Inco Thompson Nickel Mines in Canada).
- The mining operations are expected to eventually suffer a significant increase in the rate of taxation as a result of a forthcoming national election and so a greater rate of production is assigned (e.g. Santa Dominga Gold Mine in Chile).
- A financial sponsor that is a government authority may insist that the production rate be lowered from the economic optimum to minimize demographic impact and prolong local employment (e.g. Nanisivik Zinc Mine in the Arctic).

Risk Analysis

"When you cannot measure risk your knowledge is of a meager and unsatisfactory kind."

Lord Kelvin

Risk in the context of a mining venture is an alteration of anticipated cash flow caused by an unforeseen circumstance or event.

The elemental actuarial risk analysis formula is Risk = probability x magnitude. That is, if the probability of an untoward event (such as a prolonged power outage) is one chance in fifty and the cost of the event (if it occurs) is estimated to be \$500,000 then the risk is \$10,000. Unfortunately, this simple analysis is not sufficient for mine evaluation purposes. More sophisticated procedures are required.

Mining risk may be assigned to two categories.

- Direct (associated with the mining activity)
- Indirect (independent of the mining activity)

Direct risk has a recognized source in the uncertainty of estimates of grade, recovery, tonnage, operating costs, price of mineral product, etc. It is addressed in a Detailed Feasibility Study by a sensitivity (variance) analysis (refer to Chapter 7 – Mineral Economics). Such an analysis demonstrates that a low-grade orebody is sensitive to operating costs and commodity price. In other cases, it may reveal a sensitivity that is not so obvious. It is important to note that this economical procedure does not recognize certain risks inherent to mining activity, such as pit slope failure, stope failure, run of muck, or a shaft incident. Neither does it normally account for a possible future increase in the rate of taxation nor future enactment of other punitive legislation.

Indirect risk may be sub-divided into two categories. The first category includes risk that may be mitigated by insurance. For example:

- Underwriter insurance provides safe design criteria and protects against fire,
- Marine insurance protects against loss at sea, and
- Bonding protects against contractor default.

The second category of external risk concerns those events against which there is often no remedy available. Usually, these are categorized as “force majeure.” They include risk associated with war, insurrection, civil disruption, riots, sabotage, earthquakes, work-to-rule (slowdown), strikes, lockouts, etc. Normally, there is no protection for this sort of risk; however, there are exceptions.

- Insurance obtained from the home country federal foreign development agency or the Multilateral Investment Guarantee Agency of the World Bank protects against political risk.
- A major mining company recently obtained a “no strike/no lockout” agreement before committing funds to a large expansion project at one of its minesites.

In the financial analysis, risk is considered in two important places. Risk is a component of the discount rate used to determine NPV and is a component of the hurdle rate (threshold value) established for the required minimum rate of return (DCF-ROI). Scrutiny of the economical evaluation process reveals that the risk factor actually employed (expressed as a percentage in both cases) does not have a rational or statistical origin that encompasses all the applicable risks. In fact, it is really a notional or judgmental figure.

As a consequence of imprecise risk analysis (and for other reasons), many mining companies and financial lending institutions now believe that competitive cost analysis is the most reliable tool for economic appraisal. The basic premise of this analysis is that only by being a low-cost producer can a mining venture combat low metal price cycles and other unpredictable risks. If a mine can produce its product at less cost than other mines, the mine can weather the storms and remain in business to ultimately reap the benefits of a great increase in demand resulting from cyclic recovery and the interim demise of high-cost operations elsewhere. The procedure requires a data bank of applicable mining statistics that have been assimilated on a global basis.

Mine Manning

This important aspect of the feasibility study is often inadequate. Normally, it includes an organization chart, manning lists, job descriptions, and outlines job-training programs. The Mine Manning portion usually includes a description of the shift rotations and an assessment of incentive payments (bonus schemes) that may be instituted.

One of the enigmas of feasibility studies is that the predicted productivity (tons per manshift) may be three times that achieved elsewhere in mature mining operations of comparable size. The typical reasoning put forth is that the high efficiency of labor will be accomplished by technical means such as:

- Scale of equipment (i.e. 50 tonne underground trucks and 12 tonne LHD units),
- Efficiency of equipment (reliability, availability, utilization, on-board diagnostics, etc.),
- Bulk mining methods to replace tedious selective mining methods, and
- Comprehensive computerization to replace manual procedures.

In fact, great efforts are expended in advance to ensure the technical efficiency of the mine (as described above). At the same time, the typical feasibility study is characterized by relatively small efforts directed towards the comprehensive planning of a system that will ensure an efficient and effective labor force for the life of mine, which is unfortunate for three reasons.

- The credibility of the study is imperiled when personnel management is not given appropriate attention.
- A long lead-time is required to devise and plan a comprehensive program.
- The time to implement a new program is at the outset of new mining operations; it is much more difficult to do so after operations are underway.

The classic tool for the efficient personnel management is an incentive program (bonus system).

The historical purpose of an incentive program was simply to increase productivity. The assumption was that high productivity means low mining costs, which is the aim of any mining operation. *However, the real goal of any mining operation is to maximize and sustain profitability.* To meet this goal, the modern incentive program must contain the following 14 roles. The first seven relate to technical efficiency and the second to behavioral efficiency.

1. Increase productivity
2. Minimize dilution
3. Reduce downtime
4. Improve maintenance → Technical work efficiency → Maximize profit
5. Encourage recycling
6. Reduce waste
7. Exercise cross training

1. Improve safety
2. Turn self-interest into teamwork
3. Reduce absenteeism
4. Reduce turnover → Effective human relations → Sustain profit
5. Improve communications
6. Encourage self development
7. Minimize grievances

It is difficult to devise an incentive program to meet all these requirements; however, most of them have already been addressed at existing mining operations. Not all at one mine, but nearly all when systems developed at different mines are looked at together as a whole. It is beyond the scope of this handbook to describe in detail how each of these 14 roles may be instituted – the following paragraphs describe briefly how some of them have been implemented successfully.

1. Productivity

It is notable that in industrialized countries, a wide variation exists between older established mines and those that have recently come on stream. The old mines report productivity as low as 10-15 tons per manshift, while newer mines often achieve 30-35 tons per manshift. (It should be noted that accepted practice is measuring a "manshift" as 8 hours and the number of manshifts taken for the calculation of productivity refers to all on-the-job employees that report to the mine superintendent.)

There remains significant opportunity for an increase in these "norms" of productivity. In 1990, Algoma Steel's MacLeod Mine at Wawa Ontario achieved a productivity of 90 tons per manshift. This underground mine produced 1,100,00 tons per annum, mainly from Blasthole stoping. All personnel were on a bonus system, based on tonnage. (There was no dilution problem at this mine due to the huge size of the orebody.) The philosophy of a mine-wide incentive is likely to have been a significant factor in this achievement, since it was also employed at another mine that was very productive (see below). This concept has been found to help to reduce bickering, alienation, self-interest, and a host of other problems. The incentive program engenders teamwork among the employees, and teamwork is the cornerstone of successful personnel management.

2. Dilution

It is imperative that an incentive program be designed to minimize dilution. One cost of dilution is the cost of handling the waste rock (or backfill). Another cost is in the metal carried by it from the mill to the tails (typically 1.5 to 2 kilograms per tonne of waste in a base metal mine). The largest cost is the profit lost from not mining ore.

The problem of dilution was addressed by introduction of the “standard ton.” In this case, each ton of scheduled production is assigned an estimated metal content to which actual output may be compared. The estimate is based upon ore reserve data and historical dilution experience. Implementation of the “Standard Ton” concept at one mine (Campbell Chibougamau) resulted in ore grade improvement that was even better than expected.

The mine-wide incentive program was successful at this mine on other fronts.

- The accident frequency was reduced from approximately equal to the industry average down to less than half.
- Absenteeism was reduced from 11% to 5%.
- Turnover was reduced by two-thirds.
- Grievances with the union reduced from 50 cases annually to five in three years.

Preparation of Side Studies

One important technique employed in preparing a Detailed Feasibility Study is the use of side studies as a means of settling important issues without interrupting the progress of the main study. Typically, a small team of technical people is assigned the responsibility of developing a side study and issuing a report containing recommendations.

Following is a list of items that frequently become the subject of side studies.

- | | |
|--|---|
| • Purchase versus rental of equipment fleet. | • Rail versus truck haulage. |
| • Company forces versus contracting outside. | • Koepe versus drum hoist. |
| • Selective versus bulk mining methods. | • Concrete versus steel headframe. |
| • Block cave versus Blasthole mining. | • Fully Autogenous Grinding (FAG) versus Semi-Autogenous Grinding (SAG) mill. |
| • Gyratory versus jaw crusher. | • Carbon-in-leach (CIL) versus carbon-in-pulp (CIP) process. |
| • Apron versus vibratory feeder. | • Slurry line versus trucking concentrate. |
| • Conveyor versus rail transport. | |

The conclusion and recommendation of the side study is based on an economic and practical appraisal of alternatives. The appraisal is normally completed by conducting separate exercises that may include the following activities.

- Literature search to find relevant texts, articles, and technical papers.
- Solicitation of opinion from experts in the field.
- Telephone conversations with operators at existing installations.
- Site visit to one or more relevant mining operations.
- Case studies that assemble and assess pertinent data from other mines.
- Review of quotations or proposals.
- Interviews with technical representatives of manufacturers, contractors, etc.

The basic procedure is first to develop a list of significant economic and practical attributes and then compare them. Subsequently, the advantages and disadvantages are identified. Each attribute is then assessed as to project relevance and summarized to reach a conclusion.

In one technique, each attribute is ranked by (1) inherent significance and (2) relevant application to the project. Typically, estimates for each of these two values are scaled to a number between one and ten. The results are summarized on a simple spreadsheet that multiplies the two estimated values for each attribute (Keynesian theory). A separate column contains the products of the multiplication for each alternative, which are then added to obtain a score. The alternative with the higher score wins.

While this technique is not always applicable, it is one that provides an easily understood rational evaluation. In addition, it simplifies changes made after review and facilitates diligent scrutiny by others.

Example – Advantages and Disadvantages

Where it is established that shaft hoisting is required for a proposed mine, a determination is often required whether to employ a drum hoist or a Koepe (friction) hoist. The following example contains a generic list of attributes for a typical side study assembled in a format that separates advantages and disadvantages.

- Advantages of the Koepe Hoist
 - A new Koepe hoist is less expensive to purchase than a new drum hoist for the same service.
 - The delivery time for a new Koepe hoist may be less than a new drum hoist for the same service.
 - More competition exists in the manufacture of friction hoists.
 - A multi-rope Koepe hoist has a capacity to lift a heavier payload than a single-rope drum hoist.
 - The peak power consumption is less, requiring a drive of smaller nameplate horsepower for equivalent service.
 - The energy consumption and peak power recorded by a demand meter are virtually the same for a Koepe or drum hoist for equivalent service, but the effects on a sensitive power grid are less for a Koepe hoist.
 - The Koepe hoist does not regenerate significant power into the grid, which may be of consequence when the power is supplied by on-site generators.
 - The Koepe hoist does not require safety dogs for man carrying conveyances.
 - The Koepe hoist is of smaller diameter than a drum hoist for the same service, hence easier to transport and erect for an underground blind shaft (winze).
 - Rope life is usually much longer than for a drum hoist.
 - A Koepe hoist can operate at higher speed than a drum hoist.
 - A Koepe hoist does not have the problem of flying rope grease.
 - A Koepe hoist may be readily converted to a single drum hoist with provision of a hawse hole and drum lagging.
- Disadvantages of the Koepe Hoist
 - A balanced Koepe system is not satisfactory for hoisting from loading pockets at different horizons in the shaft. For this service, a skip/counterweight configuration is required.
 - A Koepe hoist is generally not suited to shaft deepening.
 - A Koepe hoist is not satisfactory for sinking deep shafts.
 - The braking effort is restricted by the requirement to maintain friction between the head ropes and drum.
 - If the shaft bottom is flooded, the Koepe hoist is automatically slowed to creep speed.
 - A used Koepe hoist is difficult to find to fit a particular application.
 - Rope replacement is accomplished with great effort and may require a mid-shaft rope changing station if the shaft is deep.
- Advantages of the Drum Hoist
 - The drum hoist requires less downtime for routine maintenance.
 - The maintenance regime for a drum hoist is less sophisticated.
 - The drum hoist can continue to operate normally when the shaft bottom is flooded.
 - Less shaft depth is required beneath the loading pocket.
 - Less over-wind and under-wind protection is required.
 - Because it has no tail ropes, the drum hoist system is better suited to slinging loads beneath a conveyance.
 - The drum hoist is less subject to nuisance trip-outs because it is equipped with fewer control and safety devices.
 - Less investment in spare rope inventory is required of a drum hoist.
 - If one conveyance is jammed in the shaft, emergency access may be had with the other conveyance of a double drum hoist.
 - If a shaft wreck occurs, it is typically less catastrophic with a drum hoist than with a friction hoist.
 - The drum hoist has a more liquid market and higher salvage value when it needs to be replaced or is no longer required.

- Disadvantages of the Drum Hoist
 - The drum hoist generates power at the end of the wind, which goes back into the power grid. If the grid is provided by generated power, this can become a problem because generators are designed to produce and not receive power. This problem is more acute with multiple generators fighting to maintain synchronization. The problem is alleviated if an independent steady load is included in the generator grid (to act as a sink for power generated by the hoist).
 - The spikes of the drum hoist cycle are also a problem for generators. They do not react well to rapid fluctuations in demand, particularly if the generators are not over-sized for the application.
 - A drum hoist takes up more space than a friction hoist, for the same service.
 - A drum hoist is more likely to have problems with rope whip, particularly when operating at high speeds.
 - To change the rope diameter on a drum hoist requires a new drum sleeve or shell, while on a Koepe hoist, only the tread liners need be replaced.
 - For application underground, the drum hoist may have to be specially manufactured with sectioned drums to fit travel-ways.

7.0 Mineral Economics

7.1 Introduction

Mineral economics involves the following four principal areas of concern.

- Accounting practices
- Financing
- Commodity markets
- Economic evaluation

7.1.1 Accounting Practice

Accounting practice for mining companies follows accepted standards for resource industries with the only significant modification being the treatment of depletion and royalties. The treatment depends mainly on the applicable laws at the mine location. Accounting practice for mining contractors is different from mine owners and follows accepted standards for the construction industry. Accounting practices are not pursued in this chapter except where they relate directly to financial evaluation.

7.1.2 Commodity Market

Commodity market volatility is of great concern to a mineral producer. In the past, some metal mining alliances have attempted at various times to control the price of zinc, tin, and silver with no permanent success. Anti-monopoly legislation strongly condemns manipulating commodity markets in the United States, as it does to a lesser degree in other industrialized nations. Selling prices of metals may be legally secured in the short term by forward selling; however, there is normally no assurance in the longer term. Normally it is the longer term that applies to the period of time that it takes to bring an orebody into production and thereafter. Since it is now generally accepted that future metal prices are unpredictable, the commodity market is given little consideration in this chapter.

7.1.3 Financing

Financing required for the construction and operation of mining projects may be provided internally, but most mining companies resort (at least in part) to joint venture partners, independent financial institutions, international development agencies, local governments, and/or the equity market to provide the capital they require. This chapter does not deal with financial instruments or the mechanics of borrowing money. The only relation to financing is the reference to "due diligence," which is a requirement of vigilant financial sponsors.

7.1.4 Economic Evaluation

Economic evaluation (investment analysis) is at the heart of feasibility studies and due diligence. These are of immediate and significant concern to the mining community. For this reason, financial evaluation is the primary focus of this chapter.

"It looks just a little more mathematical and logical than it is; its exactitude is obvious, but its inexactitude is hidden..."

G. K. Chesterton

"The process of finding and developing mines, including the financing of these activities, involves a chain of activities and people. Such a chain is only as strong as its weakest link."

Kenneth Grace

Economic studies for proposed new mines and expansions of existing mines that demonstrate a rate of return less than 15% rarely proceed to fruition; yet, the actual return on investment is less than 10% (on average). The list of 30 companies that make up the well-known Dow Jones Industrial Index no longer includes any mining corporations. A study by Morgan Stanley of the 21-year period between 1979 and 2000 reveals that the profitability of mining fell far short of that obtained by most other industries. Perhaps there is something wrong with the manner in which financial evaluation has been conducted by the mining industry.

In these days of specialization, the mining engineer no longer performs detailed economic calculations, such as those required of a definitive feasibility study. Instead, the calculations are typically performed by the mine's financial department or an independent institution (employing financial analysts armed with specialized computer programs). The calculations themselves can be done in a split second. Unfortunately, this facility with numbers can provide opportunity to maneuver or misinterpret key data and produce an erroneous conclusion. One result is that investors have become more suspicious of glowing financial projections and miners (who live with the consequences) are required to become adept at auditing reports prepared by others.

Such an audit is the most significant part of the due diligence procedure. Due diligence has become regular practice whenever mineral properties are about to change hands or independent financing is proposed.

The information in this chapter is selected to help direct the reader to identify potential flaws in traditional methods of financial evaluation, assist with due diligence, suggest means to ensure the viability of a proposed mining venture, and outline the procedure for optimizing return from a mature mining operation.

7.2 Rules of Thumb

Metal Price

- The long-term average price of a common mineral commodity (the price best used for economic evaluation in a feasibility study) is 1.5 times the average cost of production, worldwide. *Source:* Sir Ronald Prain

Pre-production Capital Cost

- The pre-production capital cost estimate (Capex) should include all construction and operating expenses until the mine has reached full production capacity or three months after reaching 50% of full capacity, whichever occurs first. This is the basic transition point between capital and operating costs. *Source:* John Halls
- The pre-production capital cost expenditure includes all costs of construction and mine development until three months after the mine has reached 25% of its rated production capacity. *Source:* Jon Gill

Cash Flow

- The total cash flow must be sufficient to repay the capital cost at least twice. *Source:* L. D. Smith
- Project loans should be repaid before half the known reserves are consumed. *Source:* G.R. Castle
- Incremented cash flow projections should each be at least 150% of the loan repayment scheduled for the same period. *Source:* G.R. Castle
- The operating cost should not exceed half the market value of minerals recovered. *Source:* Alan Provost

Net Present Value

- The discount factor employed to determine the NPV is often 10%; however, it should be Prime + 5%. *Source:* G.R. Castle
- The increment for risk may add 4% to 6% to the base opportunity cost of capital in the determination of a discount rate. *Source:* Bruce Cavender
- The value of the long-term, real (no inflation) interest rate is 2.5%. This value is supported by numerous references in the literature. *Source:* L.D. Smith
- In numerous conversations with managers of mining firms, I have found that 15% in real terms is the common discount rate used for decision purposes. *Source:* Herbert Drecshler (1980)
- In 1985, the discount rates of many mining companies ranged from 14% to 15%. *Source:* H. J. Sandri
- The true present value (market value) of a project determined for purposes of joint venture or outright purchase is equal to half the NPV typically calculated. *Source:* J. B. Redpath

Rate of Return

- The feasibility study for a hard rock mine should demonstrate an internal rate of return (IRR) of at least 20% – more during periods of high inflation. *Source:* J. B. Redpath

Working Capital

- Working capital equals ten weeks operating cost plus cost of capital spares and parts. *Source:* Alan O'Hara
 - Working capital is typically ten weeks of operating cost plus the spare parts inventory. *Source:* METSInfo
-

Closure Costs

- The salvage value of plant and equipment should pay for the mine closure costs. Source: Ron Hafliidson
 - For purposes of cash flow, the cost of reclamation used to be equated with the salvage value of the mine plant, but this is no longer valid in industrialized nations. Source: Paul Bartos
-

7.3 Tricks of the Trade

- The goal is to maximize the economic value of a mineral resource. In mining, this only occurs when the ongoing economic profit and the long-term value are maximized simultaneously. Source: Juan Camus
- The optimum production capacity is not sensitive to the taxation rate. This means that it may be accurately calculated before a comprehensive determination of the applicable tax rates is completed. Source: L. D. Smith
- The capital cost estimate should be calculated in both constant (current) and escalated dollars, but the operating cost estimate and revenues should not be escalated, except in corollary sensitivity analyses. Source: John Halls
- In theory, sunk cost should not be included in the capital cost estimate. In fact, the sunk costs may be written off only if the project fails the evaluation. If the project proceeds, the sunk costs survive and by standard accounting practice, they later appear in the operating cash flow. This is one reason why sunk costs are often found included in the financial evaluation. Source: Douglas Stirling
- The working capital requirement is often estimated as being equal to three months operating cost. This may not be enough; the working capital requirement is closer to three months revenue if the revenue in cash flow is valued when produced rather than when received. By deferring the revenue stream three months or more as appropriate, the operating costs are left in the cash flow as expended. Source: Douglas Stirling
- Operating costs include maintenance, repair, and minor equipment replacement. Source: R.J. Vance
- Equipment replacement more than \$US 5,000 should be capitalized. Source: Arthur Park
- Cash flows are typically spread in intervals of one month for the pre-production phase and by quarters or annually thereafter. Source: Douglas Stirling

7.4 Economic Evaluation

The standard principles of economics used generally in the broad scale are also applied to the mining industry. Four standard measurements that are well understood by economists are typically applied to mine evaluation.

- NPV
- Rate of Return on Investment (IRR)
- Payback
- Competitive Cost

The first three of these are interrelated to the extent that they consider a mine as a wasting asset and each of them utilizes cash flow in their analysis. Each is often assumed to be a separate test of validity; however, as will be seen, they are all merely variations of the same mathematical routine when analyzed from an engineer's viewpoint.

7.4.1 Cash Flow

Cash flow may be described in general terms as the cash generated from operations in a specified period of time (month, quarter, or year). For evaluation purposes, it is the net of estimated cash inflows and outflows for operations. The cash flow determination for an evaluation can be simpler than for actual on-going operations. In the context of a financial evaluation for a mine, cash flow may be generally defined by the following computation.

	Gross Revenue
Less	<u>Selling and transportation costs</u>
=	Net revenue
Less	<u>Mine operating cost</u>
=	Gross profit
Less	<u>Capital cost allowance (depreciation)</u>
=	Income before exploration deductions
Less	<u>Exploration and development deductions</u>
=	Depletable income

Less	<u>Depletion allowance</u>		
	=		Taxable income
Less	Mining taxes		
Less	<u>Corporate income taxes</u>		
	=		Net profit
Plus	Capital cost allowance (depreciation)		
Plus	Depletion allowance		
Plus	<u>Exploration and development deductions</u>		
	=		Cash Flow

Cash flow is further defined and discussed in the appendix to this chapter.

Net Present Value

NPV may be described as a rational attempt to put a dollar value on the mineral property. It is also described as a measure of liquidity. A more accurate definition is that NPV is the difference between the present value of the positive and negative cash flows, discounted to the present time at a predetermined interest rate. Financial analysts define it simply as the sum of discounted cash flows. The NPV calculation considers that the calculated profits from a proposed mining venture are an annuity for the estimated life of the mine. In simple terms, the NPV is the present value of the annuity less the initial investment and is usually expressed in millions of dollars.

The NPV procedure may be used also to help assess the value of an operating mine that is for sale.

NPV Calculations

Calculations require projected cash flows at regularly spaced intervals (months, quarters or years). NPV may be computed using the formula given below, or by using a table of present value dollars. Most computer spreadsheet programs also provide a built-in function for calculating NPV given a series of cash flows.

$$NPV = \sum_{i=1}^n \frac{\text{cash flow values}_i}{(1 + \text{discount factor})^i}$$

Discount Factor

A discount factor is first determined to perform the NPV calculation. A figure of 10-15% is common in the hard rock mining industry. The discount typically consists of the sum of two components: the safe return rate plus a risk rate¹. The safe return figure is a tangible real market rate while the risk figure is often an arbitrary or notional rate.

¹ Economists employ more precise definitions such as the sum of the base opportunity cost, transaction cost, project risk, technical risk, operations risk, and country risk.

Safe Return Rate

The rate of safe return is that provided from a safe alternate investment, such as federal government bills or bonds. It is a simple matter to decide an accurate value for this figure.

Risk Rate

A good number for the risk rate is not so easily determined and was dealt with in the previous chapter of this handbook. The risk rate is a weak link in the financial evaluation.

Example

Determine the NPV for the following mining project.

- Facts:
1. Assume a discount rate of 15%
 2. \$100 million initial investment
 3. The project will return \$35 million in each future year
 4. The calculated mine life is five years.

Solution:

$$NPV/\$1 \text{ million} = -100 + 35/1.15 + 35/1.15^2 + 35/1.15^3 + 35/1.15^4 + 35/1.15^5 = 17.3$$

$$NPV = \$17.3 \text{ million}$$

7.4.2 Rate of Return on Investment

Rate of return on investment is the return on pre-production capital investment expressed as a percent in which both the capital investment period (negative cash flow) and the subsequent revenue stream (positive cash flow) are discounted to the date of initiation of major capital investment. More simply, it may be described as the maximum rate of interest that could be paid for the capital employed over the life of the mining investment without the venture incurring a loss.

Financial analysts currently define the rate of return on investment as “discounted cash flow rate of return on investment” (DCF-ROI). It is identified as “IRR” in typical computer spreadsheet programs.

The standard formula given below defines rate of return on investment as that discount rate at which the present value of positive cash flows equals the present value of negative cash flows. It is the value of the “discount factor” in the previous formula when equated to zero.

$$NPV = 0 = \sum_{i=1}^n \frac{\text{cash flow values}_i}{(1 + \text{discount factor})^i}$$

Most computer spreadsheet programs also provide a built-in function for calculating the IRR; however, IRR can also be calculated manually by trial-and-error and interpolation between results.

Example

Determine the rate of return on investment for the same mining project.

- Facts:
1. The mining project has a \$100 million initial investment
 2. The mining project will return \$35 million in each future year
 3. The calculated mine life is five years.

Solution:

$$NPV/\$1 \text{ million} = -100 + 35/1.221 + 35/1.221^2 + 35/1.221^3 + 35/1.221^4 + 35/1.221^5 = 0$$

$$DCF\text{-}ROI = 22.1\%$$

The value obtained from this economic computation is traditionally the most significant measure of project feasibility. It is also commonly employed to rank alternative scenarios for an individual project or several proposed projects competing for limited resources.

Threshold Rate of Return

Consideration of risk enters the evaluation procedure when a threshold (hurdle) rate of return is established to confirm or deny the viability of a project. Like the discount rate developed for the NPV calculation, the threshold rate of return may be said to comprise the sum of a safe rate and an arbitrary risk rate. Presumably, the threshold value determined for the rate of return takes a more conservative view of risk into account than does the discount rate determined for the NPV, since it is typically found to be at least 5% higher.

7.4.3 Payback

Payback is the period of time (measured in years) that the accumulated cash flow could retire the pre-production capital invested without considering the time value of money. More simply, payback is the number of years needed for the cash inflows to equal the cash outflows. This measure is not considered as significant as the other two (NPV and IRR). One reason it is calculated is to determine whether the project meets the empirical requirement – that pay back occurs not later than the date that half the ore reserves are exhausted. Payback may be obtained by solving for the maximum value of ‘n’ in the previous formula (at a “discount factor” of zero) or by inspection of the cash flow spreadsheet.

Example

Determine the payback for the same mining project.

- Facts:
1. The project has a \$100 million initial investment
 2. The project will return \$35 million in each future year
 3. The calculated mine life is five years.

Solution:

$$-100 + 35/(1+0) + 35/(1+0)^2 + 30/(1+0)^3 = 0,$$

$$\text{Payback} = 35/35 + 35/35 + 30/35 = 2.9 \text{ years}$$

(In this example, payback occurs after half the ore reserves are exhausted, and, therefore, does not meet the empirical requirement.)

Sensitivity Analysis

A sensitivity analysis (variance analysis) is normally performed once these first three procedures are developed. It is the process of determining the sensitivity of the present value, rate of return, and payback of the project for any one input variable. Once a series of variables has been examined, two of the input variables may be combined together for consideration (this is uncommon). An example of a variable would be a 10% fall in metal price. If the fall results in more than a 20% decrease in the rate of return, the project is deemed to be sensitive to metal prices. Sensitivity results are frequently plotted in simple graphical form to illustrate the risk applicable to each variable. The identification of such sensitive relationships indicates areas where extra study may be warranted to confirm or improve estimate accuracy. In some cases, a statistical probability evaluation is applied to the results of sensitivity analyses.

7.4.4 Competitive Cost

Competitive cost analysis is considered by many mining companies and financial lending institutions to be the most reliable tool for economic appraisal in today's volatile market for mineral commodities. The analysis consists of comparing the estimated cost of producing the mineral commodity with the range of actual costs incurred at other mines around the world that produce the same product. The cost data may be obtained from an investment service.

The data is arranged on a spreadsheet that provides cost and annual production for each significant producer in separate columns. A third column contains the total cost of production that is obtained by multiplying the figures for each entry in the first two columns. The columns for production and total cost of production are added to obtain totals that are then divided to obtain an estimate of the average cost of production on a worldwide basis*. Further analysis produces a figure for the lower quartile cost of production.

If by competitive cost analysis, the estimated operating costs are lower than the average cost of production, it is a favorable indication. If the estimated operating cost lies within the lower quartile, its viability is considered proven by this analysis.

The theory and advantages of the competitive cost analysis method are dealt with in the previous chapter. The weakness of this procedure is that it takes no account of capital costs and does not consider the time value of money. No project should be evaluated solely on this basis.

*The average cost may also be used to determine a fixed metal price for the previous three evaluation procedures (refer to Sir Ronald Prain's rule of thumb).

Case History

Early in this century, the Anaconda Company performed a financial analysis on its Portrerillos property in Chile that indicated a financial return lower than hoped for due mainly to the long pre-production development schedule. The company proceeded with the project anyway; secure in the knowledge that it would be a very low cost producer. The mine weathered the great depression and later provided funds for other ventures in Chile that eventually (towards the middle of the century) provided for regular repatriation of \$300 million a year from profits.

7.5 Operating Mine Economics

Economy of operations is as important, or at least comparable, to the economics of a proposed mining project, yet it receives far less attention in the literature. The procedure for investing in a mine expansion is essentially the same as for a new project, as already discussed; however, as a mine's reserves diminish, it is prudent to review the economics particularly with respect to the scale of operations (mine capacity). It is a common misunderstanding that the scale of operations should remain fixed until the day reserves are exhausted. Typically, it is more economical to reduce the scale of operations late in the mine life.

Part of the problem is the misconception that the degree of grind required in a mill (concentrator) to release mineral particles from the gangue (waste rock) is a fixed, threshold number. In most cases, the grind is a variable that is established by its relation to recovery. The capacity (and a significant portion of the cost) of an existing mill is the degree of grind. In other words, the capacity of a mill (and hence the mine) may be increased from its nominal capacity at the expense of recovery and vice-versa. It is also the case that to meet a "rated capacity," the grinding mills may be running past the optimum speed (i.e. RPM) at the expense of much higher power consumption. Thus, it can be seen that in this case, reduction in the scale of operations may result in a cost benefit, contrary to general opinion.

The grinding process is used as an example because it is the major cost of milling. There are a number of other examples in the mine and mill that have a similar relationship to the scale of operations.

Case History

The classic example occurred at the Granduc mine (8,000 tpd capacity). At a point in its life, the price of its product (copper) fell into a steep decline to the point that the mine was losing a lot of money. It was decided to reduce production and lay off a significant portion of the workforce. The surprising result was an increase in productivity and lower unit operating cost.

7.6 Appendix

Notes on Cash Flow (courtesy of Douglas Stirling)

In the project evaluation process or ongoing operating analysis, cash flows may be calculated slightly differently by different companies and for different purposes.

In terms of evaluation, operating cash flow could be defined generally as the cash generated from operations. It might typically be the net of the cash inflows and outflows for operations determined as follows.

1. Net revenues from products (net of any selling and transportation).

Less

2. Production costs (labor, materials, services, etc. on the accrual basis).
3. Non-cash production costs (depreciation, development write off, exploration write off, reclamation accruals, etc.).
4. Pre-tax earnings/profits.
5. Income taxes (federal, state/provincial – cash and non-cash).
6. After-tax earnings / profits (on accrual basis).

To find "operating cash flow" from operations, one must add back the non-cash operating items.

Plus

(Some or all of the following, depending on purpose or company preference, would be shown separately so the reader can understand and adjust the information as they wish).

7. Non-cash costs (depreciation, depletion or other write-offs for exploration, development, property acquisition, deferred income taxes, reclamation, etc.).
8. Interest (that relating to property acquisition).
9. Royalties paid to a property owner for their ownership interest (may be a profit sharing rather than a production cost).
10. Plus or minus working capital changes during the period depending on the change + or -.
11. **Cash flow from operations** (before ongoing capital requirements).

Less

12. Ongoing capital, exploration, and development expenditures considered non-period operating costs would be capitalized so would not be included in the operating financials income statement.
13. Working capital changes (+ or -).
14. **Net Cash Flow** (after ongoing capital requirements).

The preceding calculation may be done on a stand-alone mine or mine property basis to the headworks / load out facilities, or may include processing facilities if stand alone or on a shared basis. Down the line costs from load out would typically be segregated so that the individual values are known. Other costs that may be used in the evaluation are shared corporate cost allocations, sunk costs (costs incurred prior to the evaluation date), interest for financing, royalties etc. (some of which have been discussed above).

As there is no standard classifications or formats, individual properties and ownerships often have unique items with which to deal; therefore, if the unique items are set out separately, they may be considered by any reader, as desired.

8.0 Cost Estimating

“Do not estimate your cost or schedule by telephoning contractors and asking them for ballpark figures. The only kind of estimate that is worth anything is the one that is clearly defined on paper and bears the signature of the author. This type of time or cost estimate takes time to prepare. In general, the estimate will be worth what you pay for it.”

J.S. Redpath (1980)

8.1 Introduction

Estimating for a mining company or engineering firm is the procedure whereby the cost of a proposed project is determined in advance. For a contractor competing against others, the estimate is normally the best price the company can afford to bid.

While some estimates may require scheduling, conceptual design, and development of procedures, a basic estimate simply includes take-off (quantity survey), pricing, extension, and summarization.

The quantity take-off can normally be done to good precision while the efficiency of labor (i.e. man-hours) is difficult to estimate accurately from one project to another. For this reason, it is commonly advised that labor-intensive estimates include an added contingency. The most difficult projects to estimate in hard rock mining are usually those prepared for rehabilitation of existing mine workings or equipment, mainly due to the fact that the quantity of work required can be difficult or impossible to measure accurately in advance.

Estimates usually are divided into direct and indirect costs. Estimating direct costs is a fundamental exercise; however, estimating indirect costs requires a project schedule, since indirect costs are mainly time dependent. For this reason, estimators are frequently schedulers as well.

In North America, the estimator is normally expected to be adept at quantity take-off, pricing, and scheduling. For large projects, specialists may perform the scheduling separately.

In this chapter, no actual cost tabulations will be found because rates and prices change with geography and can escalate rapidly in a short time frame. This chapter is devoted instead to relatively constant definitions, particulars of procedures, and tabulations of performances, etc.

8.2 Rules of Thumb

Cost of Estimating

- A detailed estimate for routine, repetitive work (i.e. a long drive on a mine level) may cost as little as 0.5% of the project cost. On the other hand, it may cost up to 5% to adequately estimate projects involving specialized work, such as underground construction and equipment installation. *Various Sources*

Cost of Feasibility Study

- The cost of a Detailed Feasibility Study will be in a range from 0.5% to 1.5% of the total estimated project cost. *Source: Frohling and Lewis*
- The cost of a detailed or “bankable” feasibility study is typically in the range of 2% to 5% of the project, if the costs of additional (in-fill) drilling, assaying, metallurgical testing, geotechnical investigations, etc. are added to the direct and indirect costs of the study itself. *Source: R. S. Frew*

Budget Estimates

- An allowance (such as 15%) should be specifically determined and added to the contractor’s formal bid price for a mining project to account for contract clauses relating to unavoidable extra work, delays, ground conditions, over-break, grouting, dewatering, claims, and other unforeseen items. *Source: Jack de la Vergne*

Engineering, Procurement, and Construction Management

- The Engineering, Procurement, and Construction Management (EPCM) cost will be approximately 17% for surface and underground construction and 5% for underground development. *Source: Jack de la Vergne*
-

Overbreak

- The amount of over-break to be estimated against rock for a concrete pour will average approximately 1 foot in every applicable direction, more at brows, lips, and in bad ground. *Source:* Jack de la Vergne
- On average, for each 1 cubic yard of concrete measured from the neat lines on drawings, there will be 2 cubic yards required underground, due to overbreak and waste. *Source:* Jack de la Vergne

Haulage

- The economical tramming distance for a 5 cubic yard capacity LHD is 500 feet and will produce 500 tons per shift, for an 8-yard LHD, it is 800 feet and 800 tons per shift. *Source:* Sandy Watson
- Haulage costs for open pit are at least 40% of the total mining costs; therefore, proximity of the waste dumps to the rim of the pit is of great importance. *Source:* Frank Kaeschager

Miscellaneous

- Developing countries have labor costs per ton mined equal to approximately 80% of industrialized nations, considering pay scales, mechanization, education, and skill levels. *Source:* Kirk Rodgers
 - The installed cost of a long conveyorway is approximately equal to the cost of driving the drift or decline in which it is to be placed. *Source:* Jack de la Vergne
 - The total cost of insurance on a contract-mining job will be approximately 2% of the contract value (including labor). *Source:* Darren Small
 - In a trackless mine operating around the clock, there should be 0.8 journeyman mechanic or electrician on the payroll for each major unit of mobile equipment in the underground fleet. *Source:* John Gilbert
 - On average, for each cubic yard of concrete measured from the neat lines on drawings, approximately 110 Lbs. of reinforcing steel and 12 square feet of forms will be required. *Source:* Jack de la Vergne
 - To estimate shotcrete (dry type) through the machine, add 25% to the neat line take-off to account for surface irregularity (roughness) and overbreak. Then add rebound at 17-20% from the back and 10% from the wall. *Source:* Baz-Dresch and Sherril
 - The overall advance rate of a trackless heading may be increased by 30% and the unit cost decreased by 15% when two headings become available. *Source:* Bruce Lang
 - The cost to slash a trackless heading wider while it is being advanced is 80% of the cost of the heading itself, on a volumetric basis. *Source:* Bruce Lang
-

Note

Refer to Chapter 23 for Rules of Thumb pertaining to electrical estimating.

8.3 Key Definitions and Abbreviations

- **Ball Park** = horseback = seat-of-the-pants = back of the envelope = a snap estimate.
- **Capex** = capital expenditure.
- **Direct Costs** = costs that are unique to a particular item of work. Direct costs usually include hands-on labor, lead hands, permanent materials, materials consumed in the work and equipment specifically used for work performance.
- **EPCM** = engineering, procurement, construction, and project management.
- **Indirect Costs** = Indirect costs can be further divided into cost dependent items (such as insurance and overheads) and time dependent items (such as supervision, maintenance/service personnel, equipment rentals, and utility billings).
- **Lump Sum Allowance** = A cost entered for an item of small value that is not yet specified or defined and therefore cannot be properly estimated.
- **Order of Magnitude** = conceptual = range = the second order of estimate.
- **Opex** = operating expenditure.
- **Pro Rata** = the rational division of one cost for inclusion into other applicable groups.

- **Salvage Value** = the estimated amount that will be received for mining equipment at the end of its useful life when it may only be salvaged for useful parts and components. This is net of removal and selling or stocking expenses. The term "salvage value" is preferable to "scrap value" if the item is not to be scrapped outright.
- **Residual Value** = at any time, the estimated or actual, "net realizable value" (that is, proceeds less removal and selling costs) of an asset that has useful operating life remaining. It may be the estimated or quoted buy-out price for a piece of mining equipment at the end of a particular project.
- **Take-off** = quantity survey = measurement of quantities to be estimated.
- **W/O** = write-off on equipment as a lump sum or rate (i.e. 5% of cost per month on mobile fleet).

8.4 Procedure

The procedure outlined below is applicable to a comprehensive estimate. The cost estimating procedure is shorter for less detailed or smaller estimates, as applicable.

1. Establish a clear scope of work and battery limits. Work with mine design/engineering team to establish scope (feasibility study or engineering estimate). Review Request for Proposal (RFP) document in detail (contractor's bid).
2. Compile the work and divide it up into separate work packages or disciplines.
3. Schedule the sequence of the estimating work and assign the packages.
4. Perform the quantity take-off.
5. Obtain a comparable estimate for another similar project as a model.
6. Assemble applicable historical data on costs, rates, and performances.
7. List and obtain current prices for materials and utilities. Develop labor rates and payroll burdens specific to location and classification requirements of the project.
8. List and obtain values for equipment (w/o, rental rates and/or purchase prices).
9. Define subcontracts/special services and obtain budget estimates or firm quotes.
10. Complete estimate of direct costs.
11. Schedule the project being estimated.
12. Complete estimate of indirect costs based on the schedule.
13. To the sum of indirect and direct costs, add applicable overheads, fees, insurances, etc.
14. Perform check for scope, arithmetic, logic, omissions, and redundancies.
15. Assess the risk and adjust contingencies applied to the costs and schedule.
16. Review and summarize the estimate.

8.5 Tools of the Trade

- | | |
|--|---|
| <ul style="list-style-type: none"> • Pocket calculator • PC equipped with spreadsheet program (i.e. Excel[®] or Lotus[®]) • Off-the-shelf estimating programs • Customized or in-house estimating programs • Customized cost forms (manual or electronic) | <ul style="list-style-type: none"> • In-house database (including account codes, labor burdens, performance records) • Published cost data (i.e. RS Means) • Off-the-shelf scheduling programs (i.e. Microsoft Project[®] or Primavera[®]) |
|--|---|

8.6 Tricks of the Trade

- The most common serious error in estimates is omission of a significant item. This can be overcome with the evolution of separate “catch-all” lists that are archived into a permanent database. In some cases, it is practical to establish estimating forms with the lists printed. When there are no such lists developed, the best thing to do is to obtain an itemized estimate for a similar project. It should be remembered that no two projects are identical and so a disciplined line item review should always be undertaken to ensure that nothing important is forgotten. Omission of items, the cost of which is not significant in the total cost, may be properly covered by a contingency, but in the real world it's better not to forget any item that may subsequently be assigned a separate cost code.
- Another serious error is misinterpretation of the scope of the work. It is worthwhile to clear up any ambiguous statements in the scope at the outset. This can be partly accomplished by cross-examining the participants to ensure that each has the same understanding. In some cases, further discussions are required with (and feedback from) the originator of the scope (i.e. client or engineer).
- The third serious error is a faulty schedule for the work. A common error is to assume performances achieved singly when a project calls for the same items of work to be carried out simultaneously. If the schedule is in error, there is likely to be a significant error on the total cost estimate because most of the indirect costs are time dependent. Performances used should be supported with footnotes explaining how they were determined.
- Another cause of significant error is a miscalculation of time-dependent indirect costs. One problem occurs when they are distributed pro rata on a cost basis when they should be distributed on a time or schedule basis. In either event, the estimating procedure (or program) should be set up so that the indirect cost distribution is automatically adjusted for changes made to direct costs or scheduled items.
- An error that many people make is to assume a straight 20% or 25% for the payroll burden on labor rates. It can vary from 10% to 80%. Simple calculations/information can avoid this pitfall.
- For projects of short duration, there is no problem with simplifying the time frames of indirect costs to line items (i.e. for a six-month project, a surveyor will be required for two months). However, this procedure can lead to great inaccuracies on a major project. One remedy is to compile a spreadsheet (electronic or manual) the top portion of which shows a condensed bar chart of the schedule, scaled in appropriate time frames (weeks or months). On the bottom left are listed the indirect costs, including each item of supervision, labor, support equipment, utilities, and site services. Each indirect item can then be scheduled under the bar chart for the project with reasonable accuracy. Moreover, this procedure facilitates the checking process.
- Even with every precaution taken, a completed estimate may still be faulty. An independent, knowledgeable party should review every important estimate. The estimate should be organized in a concise manner to provide an easy-to-review package.
- Another common error is to omit the extra cost of the learning curve on repetitive or cyclic work, such as shaft sinking or lateral development. A 70% learning curve is typical, but it may be as low as 50% if crews are inexperienced in the work (a 100% learning curve signifies a completely experienced crew with no learning occurring). *Source: Fatseas and Vagg*
- A contractor may modify his schedule of prices by front-end loading. In this technique, unit prices for items completed first on the schedule are increased while those items to be completed late in the schedule are decreased accordingly. The result is the same total amount bid, but with front-end loading, the contractor improves his cash flow and reduces his working capital requirement. He may alter the unit prices further if he anticipates a variation in the quantities contained in the tender document. For example, every shaft-sinking contractor knows that the planned size of shaft stations and electrical rooms is often increased, but is never made smaller.
- Future estimates may rely on the completed estimate. It should be filed in such a manner as to facilitate withdrawal of any particular information. If a project is completed following the estimate and the actual costs are subsequently determined, the files should be updated with noted variations from the estimate.

8.7 Categories and Confidence Levels of Estimates

Estimates are categorized many ways by many authorities. The number of categories varies from one authority to another, but most of them categorize estimates in an order sorted by the degree of accuracy (confidence level). The following categories and scales of accuracy are selected as appropriate for presentation in this book. The actual categorization for a particular mining project is best served with definitions that are derived for the specific project to be estimated.

Ball Park

Ball Park or “seat-of-the-pants” estimates are quick, informal approximations. They are useful when making snap judgments as to whether or not preliminary geological data holds promise to become a producing mine, for example. Ball Park estimates rely on knowledge-based intuition and simple rules of thumb. They may have accuracy in the order of $\pm 60 - 100\%$.

Order-of-Magnitude

Order-of-magnitude or “Range” estimates are the most elementary form of a formal estimate. They have accuracy in the order of $\pm 40 - 50\%$ and are typically obtained by factoring known gross costs and capacities of similar projects. For the estimator contemplating a more detailed estimate, it is often useful to first make a range estimate to give him an indication of the size and complexity of the task.

Preliminary

Preliminary or “pre-feasibility” estimates have accuracy in the order of $\pm 20 - 30\%$ and are typically obtained by factoring known unit costs and estimated gross dimensions or quantities, once conceptual or preliminary engineering is complete. Pre-feasibility estimates are typically applied to “Preliminary Feasibility” studies and are useful for (1) due diligence work, (2) to determine whether to proceed with a Detailed Feasibility Study, and, later on, (3) as a “reality check” on subsequent detailed estimates and to pinpoint high-cost areas that merit further attention.

Budget

Budget or “detailed” estimates have accuracy in the order of $\pm 10 - 15\%$ and are obtained from quantities and specifications determined by formal design engineering based on a clearly defined scope. Budget estimates are applicable to formal feasibility studies and provide budget figures for cost accounting codes that will be employed on the project.

Firm

Firm estimates are accurate on the order of $\pm 5 - 10\%$ and are typically employed by a contractor competing for tendered work. Estimates to a similar accuracy are often performed after the project is underway. In this case, they may be referred to as “control” estimates or “value engineering” estimates.

8.8 Value Engineering

Value engineering is the review of plans and specifications with the goal of making advantageous substitutions or design changes. The aim is to reduce the projected capital or operating costs and/or shorten the schedule of the work.

Value engineering is considered a duty of a project engineer or EPCM contractor; however, typically they consider only small parts of the design, rather than the design as a whole.

Contractors often employ value engineering in an effort to win a contract, which usually results in an alternate proposal. The contractor may bid only the alternate, but more often is required by the bid documents to provide two separate proposals. The danger for the contractor is that the owner may call for a second round of bidding or award to another contractor and negotiate a discount with him for the value engineering he has come by for free. For this reason, wise contractors try to avoid providing details of their alternate proposals at the time of bidding.

Value engineering should not stop once the work is underway; the owner, engineer, and contractor should always keep an eye out for potential cost savings. The savings can only be evaluated by more cost estimating.

After the project is under way, value engineering may be employed to re-evaluate a whole project when a change in scope or significant delay has occurred and it has become obvious that *cost accounting is not cost control*. In such a case, an estimated cost reduction obtained by reducing the footage of the planned pre-production development for a new mine is not value engineering; it is lousy engineering.

8.9 Calculation of Interest Costs

Interest on capital should be included in a cost estimate except when capital costs are financed internally by the mining company that owns the property. A mining company that uses capital funds (internal financing) for new mine projects receives profit not interest. A mining contractor normally adds interest to the working capital he is required to provide whether it is borrowed or provided internally.

8.10 The "Six-Tenths Rule"

The six-tenths rule is useful for obtaining a preliminary estimate when accuracy is not required.

When the cost of a plant with a certain capacity is known (A), the following quick tool may be used to estimate similar plants of different capacity (B).

$$\text{Cost(B)} = \text{Cost(A)} \cdot \left(\frac{\text{Capacity(B)}}{\text{Capacity(A)}} \right)^{0.6} = \text{Cost(A)} \cdot \text{Ratio}^{0.6}$$

This exponential rule is satisfactory in general, not only for capacity, but size as well. More accurate values have been determined for some particular applications, as follows.

- | | | | |
|----------------------------|------|---------------------------|------|
| • Crushers (size) | 0.65 | • Concentrator (capacity) | 0.75 |
| • Conveyors (capacity) | 0.85 | • Mine air heaters | 0.58 |
| • Compressors (capacity) | 0.72 | • Pumps (capacity) | 0.68 |
| • Drifts (x-section area) | 0.56 | • Vent fans | 0.66 |
| • Stoping (width of stope) | 0.40 | • Electric motors (HP) | 0.84 |
| • Underground mine labor | 0.70 | • Primary electrics | 0.70 |

Example

- Facts:
1. The installed cost of a 48-inch underground belt conveyor system will be \$839/foot
 2. Find the approximate cost of a 54-inch belt conveyor for *the same capacity*.
 3. Use the six-tenths rule, unmodified (exponential of 0.60).

Solution: Cost = \$839/foot x (54/48)^{0.6} = \$900/foot

Note

The six-tenths rule applies to capital costs or unit capital costs. It does not directly apply in determining operating costs (if the scale of operations increases, the unit cost decreases). The rule may be applied to operating costs if unity (one) is subtracted from the exponential (i.e. 0.6).

Example

- Facts:
1. The unit cost per ton mined at a 3,000-tpd underground operation is \$42.00.
 2. Estimate the unit mining cost if production is increased to 4,000-tpd.
 3. Use an exponential of 0.75.

Solution: Unit Cost = \$42.00 x (4,000/3,000)^{0.75 - 1.0} = \$42.00 x (4,000/3,000)^{-0.25} = \$39.09

8.11 Jack's Factors

When the cost of a base metal concentrator with a certain product is known, the cost of a mill of the same capacity but a different product can be determined by applying the following factors, pro rata.

Copper ¹ 1.0	Ni/Cu 1.4	Cu/Pb/Zn 1.8
Bulk con 1.0	Pb/Zn 1.6	

¹ Does not apply to Solvent Extraction and subsequent Electro-Winning (SX-EW) plants

8.12 Lang Factors

Another way to make an approximate estimate for a mine concentrator is to pick off the major items of equipment from the flow sheet, obtain budget prices, and multiply the sum of these by the applicable factor determined by H. Lang, as follows.

- | | | | |
|------------------------------|------|------------------------|------|
| • Solid Process Plants | 3.10 | • Fluid process Plants | 4.74 |
| • Solid Fluid Process Plants | 3.63 | | |

8.13 Calculation of EPCM Costs

Engineering (E)

The engineering portion of EPCM includes the following costs.

- Conceptual (Basic) engineering
- Side studies of options (trade studies)
- Detailed engineering
- Approval of fabrication drawings
- Fabrication quality control
- As-built drawings

Procurement (P)

The procurement portion of EPCM includes the following costs.

- Preparing specifications
- Vendor lists
- Vendor pre-qualification
- Purchase orders
- Contract documents
- Shop inspections
- Transport arrangements
- Receiving
- Storage
- Approvals for payment

Construction Management (CM)

The construction management portion of EPCM includes the following costs.

- Budget preparation
- Cost accounting and control
- Value engineering
- Control estimates
- Acquisition of permits
- Evaluation of quotations and tenders
- Contract administration
- Fabrication quality control
- Field quality control
- Detailed scheduling
- Schedule Monitoring
- Measurement for payment
- Survey verification
- Inventory control
- Safety enforcement
- Approving false-work designs
- Approving lift sheets
- Commissioning equipment
- Settling claims and disputes
- Archiving project files
- Settling liens
- Approving release of hold-backs

EPCM Values

The following tabulation (Table 8-1) provides suggested values for the components of EPCM for a typical hard rock mining project that employs outside services. The costs of in-house representation to oversee the EPCM contracts are included. The percentages refer to the estimated capital expenditure (Capex) of the work, including contingencies.

Table 8-1 Engineering, Procurement, and Construction Management Values

	E	P	CM	EPCM
Civil Construction	5%	2.0%	9.0%	16%
Mechanical Construction	6%	3.0%	8.0%	17%
Electrical Installations	7%	4.0%	7.0%	18%
Electronics and Control Systems	8%	5.0%	6.0%	19%
Production Shaft	5%	3.0%	7.0%	15%
Ventilation Shaft	3%	2.0%	5.0%	10%
Underground Development	1%	1.0%	3.0%	5%
Open Pit Stripping	1%	0.5%	1.5%	3%

8.14 Operating Cost Breakdown

The values in Table 8-2 were kindly provided by Mr. Derrick May.

Table 8-2 Approximate Mining Cost Breakdown

Item	Industrial Nations	Third World
Labor	55%	35%
Supplies	35%	50%
Utilities	10%	15%
Total	100%	100%

8.15 Calculation of Productivity – Typical Values

Table 8-3 shows approximate productivity values (the values are estimated median values).

Table 8-3 Calculation of Productivity – Typical Values

Activity	Measurement	Surface	Underground
Line cutting	Miles per man-shift	2	-
Clearing by hand	Acres per man-shift	0.1	-
Mechanized clearing	Acres per man-shift	0.3	-
Burning Slash	Acres per man-shift	0.5	-
Grubbing	Acres per machine day	1-2	-
Rough grading	Acres per machine day	2-3	-
Making form-work by hand	Square feet per man-hour	15	6
Erecting form-work	Square feet per man-hour	20	10
Oiling forms	Square feet per man-hour	400	-
Rebar placement	Lbs. per man-hour	120	80
Placing anchor bolts and inserts	Lbs. per man-hour	20	10
Pouring ready-mix concrete ¹	Cubic yards per man-hour	3-4	2-3
Curing concrete (cold weather)	Square feet per man-shift	200	-
Stripping form-work	Square feet per man-hour	150	100
Fabricating structural steel	Short tons per man-shift	1	-
Sandblasting structural steel	Short tons per man-shift	4	-
Painting structural steel, per coat	Short tons per man-shift	5	2
Erecting structural steel ¹	Short tons per man-shift	1.5	0.8
Touch-up structural steel	Short tons per man-shift	16	10
Erect siding (building)	Square feet per man-shift	200	-
Erect cladding (headframe)	Square feet per man-shift	100	-
Excavate & line shaft collar	Feet/day (overall)	1-2	-
Sink timber shaft	Feet per day	-	7-9
Sink bald concrete shaft	Feet per day	-	10-14
Sink equipped concrete shaft	Feet per day	-	8-12
Equip concrete shaft	Feet per day	-	45-60
Cut shaft stations – slusher	Cubic feet per day	-	1,800-2,200
Cut shaft stations – LHD	Cubic feet per day	-	2,300-3,300
Drive raw raises up to 100 feet	Feet per man-shift	-	1.75-2.25
Drive timbered raises	Feet per man-shift	-	1.5-2.0
Drive alimak raises	Feet per man-shift	-	2.5-3.5.
Set-up raise drill, same level	days	-	2-5
Drill short pilot holes	Feet per day	60-80	60-80
Drill long pilot holes	Feet per day	50-70	50-60
Ream slot holes	Feet per day	-	40-50
Ream typical raises ¹	Feet per day	40	25-35
Ream large raises ¹	Feet per day	10-20	10-20
Track drift – single heading ¹	Feet per man-shift	-	2.5

Table 8-3 Calculation of Productivity – Typical Values (continued)

Activity	Measurement	Surface	Underground
Track drift – double heading ^{1 2}	Feet per man-shift	-	2.5
Trackless drift – single heading ¹	Feet per man-shift	-	3
Trackless drift – double heading ^{1 2}	Feet per man-shift	-	3
Trackless drift – multi heading ^{1 2}	Feet per man-shift	-	3
Drill & install rock-bolts (hand)	Feet per man-shift	-	150
Drill & install rock-bolts (mech)	Feet per man-shift	-	400
Pluggger drilling	Feet per man-hour	22	20
Jackleg drilling	Feet per man-hour	-	40
Stoper drilling	Feet per man-hour	-	30
Pneumatic Jumbo drill (drifting) ¹	Feet per drill per hour		100
Hydraulic Jumbo drill (drifting) ¹	Feet per drill per hour		150
Wagon drill ¹	Feet per machine-shift	-	100
Top-hammer drill ¹	Feet per machine-shift	-	150
ITH drill ¹	Feet per machine-shift	-	50

¹ Values that may have a particularly wide variation from the values shown.

² The rate of advance (total feet per day) will increase if a second heading is available, but additional manpower is usually employed, resulting in the same productivity (or less) per manshift obtained with a single heading.

8.16 Calculation of Consumption – Typical Values

Table 8-4 shows typical consumption calculations. The values are approximate – estimated median values.

Table 8-4 Calculation of Consumption² – Typical Values

Item	Units	Consumption
Chisel steel	Feet per steel	120.0-150.0
Drifter bits ¹	Feet per bit	300.0
Drifter steel ¹	Feet per steel	1,000.0
Powder – shaft sinking	Lbs./short ton	3.0
Powder – drifting	Lbs./short ton	2.0
Powder – raising	Lbs./short ton	1.5
Powder – vein mining	Lbs./short ton	0.5
Powder – bulk mining	Lbs./short ton	0.4
Tires for LHD (scooptram)	Operating hours/tire	1,200.0
Tires for u/g haul trucks	Operating hours/tire	2,000.0
Tires – surface haul trucks	Operating hours/tire	4,000.0
Water for jackleg or stoper	USGPM	2.0
Water for air jumbo drill	USGPM	8.0
Water for hyd. Jumbo drills	USGPM	15.0
Water for ITH drill	USGPM	10.0
Water for diam. drill (AQ)	USGPM	5.0
Water for raisebore pilot	USGPM	200.0
Water for mini-bore pilot	USGPM	40.0
Rock bolts, screen & mesh ¹	Lbs/ short ton broken	2.7
Roadway ballast (dressing) ¹	Cubic yards/month/1,000 feet	60.0

¹ Values that may have a particularly wide variation from the values shown.

² See Chapter 23 for estimates of electrical power consumption.

9.0 Shaft Design

9.1 Introduction

Chapter 9 is mainly devoted to the design of vertical shafts; in particular, circular concrete-lined shafts because they are most commonly considered for new mines; however, it also deals in part with designing other types of shaft linings.

For a production shaft, design starts with determining the cross section or plan view of the shaft. The production shaft is designed to the minimum dimensions required to contain and guide the shaft conveyances, as well as provide space to place and access the utility lines. The design may include provision for a man-way compartment and ventilation duct(s). The conveyances may ride on rope guides suspended in the shaft or fixed guides supported with structural steel members (the shaft sets).

For deep shafts, the minimum diameter of a production shaft may have to be increased, either to handle the volume of permanent ventilation air required or to accommodate the shaft sinking equipment.

In the case of an open ventilation shaft, these two considerations (quantity of ventilation air and facility for shaft sinking) are the only design considerations to determine the shaft diameter.

For most hard rock mines, the circular concrete lining is now designed to the minimum practical thickness and is poured in place without reinforcing steel. The design of the lining is engineered in cases where the stiffness of the wall rock is less than the concrete, the lining is required to be watertight (hydrostatic), the temperature in the shaft will fall below the freezing point, or there is danger of ground movement.

If the shaft is to be equipped with rope guides, the required size and tension of the half-lock coil guide ropes and rubbing ropes (if required), as well as clearance between conveyances are determined as later detailed in Chapter 15 – Wire Ropes, Sheaves, and Conveyances.

If rigid guides and steel sets are to be employed in a production shaft, they are designed to take into account vertical and lateral components of loads from conveyance travel, guide friction, cage dogging (if applicable), and resistance to ventilation air flow. It is normal practice to provide extra thickness in steel members and to specify a minimum thickness to account for corrosion. Today, rectangular structural tubing is usually employed for sets and guides, and the steel is often hot dip galvanized after fabrication. The structural analysis required to design the shaft steel is relatively simple where the proposed hoisting speeds are 2,000 feet per minute (fpm) (10m/s) or less. At higher speeds of hoisting, the steel design should be performed by a qualified engineering firm.

At one time, the shaft was equipped by inserting the horizontal members (buntons and dividers) into recesses left in the concrete lining. Today, the most common practice in North America is to support the horizontal members with saddle brackets bolted to inserts left in the lining. A design innovation is to provide dividers cantilevered from the shaft wall for an auxiliary cage, and more recently, to provide dividers cantilevered from a buntun for the skips. Utility hangers once bolted to curved angle irons are now more simply inserted into key-holes cut in a curved channel section that is bolted to inserts left in the lining.

The inserts required for the shaft equipping are held in place with dummy bolts passed through the concrete forms through holes drilled to precisely measured locations. In some cases, the shaft sinker elects to eliminate the inserts and uses anchored bolts in drilled holes, instead.

The well-engineered design of a circular concrete shaft must take “constructability” (facility of shaft sinking) into account. In addition, the employment of the shaft for pre-production development may require space for a larger ventilation duct than required for sinking. The shaft compartments and station design should be reviewed for the purpose of slinging large and heavy pieces of equipment as well as bundles of supplies underground.

It is unfortunate that there are few, if any, “standard designs” for circular concrete shafts. Typically, each new shaft is designed “from scratch” to accommodate the particular requirements envisioned by the mine planners.

9.2 Rules of Thumb

Shaft Location

- The normal location of the shaft hoisting ore (production shaft) is near the center of gravity of the shape of the orebody (in plan view), but offset by 200 feet or more. *Source:* Alan O'Hara
 - For a deep orebody, the production and ventilation shafts are sunk simultaneously and positioned within 100m or so of each other. *Source:* D.F.H. Graves
-

Depth of Shaft

- The depth of shaft should be such as is able to develop 1,800 days mining of ore reserves. *Source:* Alan O'Hara
- The first lift for a near vertical orebody should be approximately 2,000 feet. If the orebody outcrops, the shaft will then be approximately 2,500 feet deep to allow for gravity feed and crown pillar. If the outcrop has been or is planned to be open cut, the measurement should be made from the top of the crown pillar. If the orebody is blind, the measurement is taken from its apex. *Source:* Ron Hafildson
- In the Canadian Shield, a rectangular timber shaft is satisfactory to a depth of 2,000 feet. From 2,000 to 4,000 feet, it's "iffy." At greater depths, rectangular timber shafts should not be employed at all. *Source:* Bob Brown

Shaft Orientation

- The long axis of a rectangular shaft should be oriented perpendicular (normal) to the strike of the orebody. *Source:* Ron Hafildson
- The long axis of a vertical rectangular shaft should be oriented perpendicular (normal) to the bedding planes or pronounced schistosity, if they are near vertical. *Source:* RKG Morrison
- The long axis of a rectangular shaft should be oriented normal to regional tectonic stress and/or rock foliation. *Source:* Jack Morris

Shaft Inclination

- In hard rock mines, shafts sunk today are nearly always vertical. Inclined shafts are still employed in some developing countries when the orebody dips or plunges at less than 60 degrees. *Source:* Jack de la Vergne

Shaft Lining

- The concrete lining in a circular shaft may be put into tension and shear by external forces where the horizontal ground stress in one direction is more than twice the horizontal stress in the other. If the lining is "stiffer" than the wall rock and/or is subjected to high pressure grouting, that may subject the lining to non-uniform compression. *Source:* Jack de la Vergne
- The stiffness of concrete (Young's Modulus of Elasticity, E) in a shaft lining is approximately 1,000 times the compressive strength of the concrete (i.e. for 3,600 psi concrete, E is approximately 3,600,000 psi, and for 25 MPa concrete, E is approximately 25 GPa). *Source:* Troxell and Davis
- The concrete lining in a circular shaft develops greater strength than is indicated by standard concrete cylinder tests, because it is laterally constrained. Tri-axial tests indicate this increase to be in the order of 20%. *Source:* Witold Ostrowski
- The pressure at which grouting takes place through a concrete lining should not exceed 50 psi (345 kPa) in the shaft collar near surface and at depth should not increase beyond the hydrostatic head by more than 25%. *Source:* Peter Grant
- Non-reinforced (no reinforcing steel) concrete linings in a circular shaft may be subjected to sufficient tension to result in crack propagation if the temperature environment is varied widely. This is especially relevant to design life if the temperature change routinely falls below the freezing point and moisture is present. It is known that concrete subjected to a tensile stress greater than 30 kg/cm^2 (425 psi) will crack. The lining of a circular concrete shaft will crack if it is subject to a fluctuation in temperature greater than 20°C (36°F). This is because the coefficient of linear expansion of concrete is $1 \times 10^{-5}/^\circ\text{C}$ ($0.56 \times 10^{-5}/^\circ\text{F}$) and the maximum allowable elongation of concrete is 2×10^{-4} . This explains why shafts in temperate climates will eventually sustain damage to the concrete walls if the ventilation air inside it is not heated during the winter months. *Source:* Prof. Yu Gonchum, China Institute of Mining and Technology
- A concrete lining may not be satisfactory in the long run for external pressures exceeding 500 psi (3.5 MPa). Concrete is not absolutely impermeable. When subjected to very high hydrostatic pressure, minute particles of water will eventually traverse the lining and as they approach the interior face (under high differential pressure) they will initiate spalling of small particles of the concrete wall. Eventually, over a period of years, repetitive spalling will destroy the integrity of the lining. Grouting through the lining may temporarily arrest this action, but it will eventually resume. *Source:* Fred Edwards
- A University of Texas study found that substituting 25 to 35% fly ash for Portland cement in high strength concrete could cut permeability by more than half, extending the life of the concrete. *Source:* Engineering-News Record, Jan/98

Shaft Lining (continued)

- The mode of buckling failure (collapse) of a steel hydrostatic liner installed in a tunnel displays three nodes while a vertical shaft produces only two (figure 8). This means that a steel shaft or (shaft collar liner) designed to tunnel design standards is likely to collapse (and has). *Source:* Jack de la Vergne
- A SF derived from building codes for a dead load (which may be 1.4) has proven inadequate by sorry experience when applied to steel hydrostatic shaft liners. For these, the minimum acceptable factor of safety is 1.7 for a temporary installation and 1.8 for a permanent structure that may be subject to corrosion (rust). *Source:* Jack de la Vergne

Ventilation Capacity

- The maximum practical velocity for ventilation air in a circular concrete production shaft equipped with fixed (rigid) guides is 2,500 fpm (12.7m/s). *Source:* Richard Masuda
- The economic velocity for ventilation air in a circular concrete production shaft equipped with fixed (rigid) guides is 2,400 fpm (12m/s). If the shaft incorporates a man-way compartment (ladder way), the economic velocity is reduced to about 1,400 fpm (7m/s). *Source:* A.W.T. Barenbrug
- The maximum velocity that should be contemplated for ventilation air in a circular concrete production shaft equipped with rope guides is 2,000 fpm and the recommended maximum relative velocity between skips and airflow is 6,000 fpm. *Source:* Malcom McPherson
- The "not-to-exceed" velocity for ventilation air in a bald circular concrete ventilation shaft is 4,000 fpm. *Source:* Malcom McPherson
- The typical velocity for ventilation air in a bald circular concrete ventilation shaft is in the order of 3,000 fpm to be economical. *Source:* Jack de la Vergne

Shaft Guides

- The single most important requirement of a guide string is to have near-perfect joints. Straightness is the second most important, and verticality probably the third. *Source:* Jim Redpath
- The force exerted on a fixed guide from a moving conveyance due to imperfections in the guide string varies (1) in direct proportion to the mass of the conveyance, (2) in direct proportion to the square of the speed of the conveyance, and (3) in inverse proportion to the square of the distance over which the deflection takes place. *Source:* Lawrence O. Cooper
- For purposes of design, the equivalent static lateral force from a shaft conveyance to the guide string may be taken as 10% of the rope end load (conveyance + payload), provided the hoisting speed does not exceed 2,000 fpm (10m/s). *Source:* Steve Boyd
- For purposes of design, the calculated deflection of wood guides should not exceed 1/400 and that of steel guides 1/700 of the span between the sets supporting them. *Source:* German Technical Standards (TAS) 1977
- Acceleration values of 8% -10% obtained from a decelerometer test are reasonable rates to expect from a new shaft in good alignment. *Source:* Keith Jones
- In an inclined shaft, guides are required for the conveyance cars (to prevent derailing) when the inclination exceeds 70° from the horizontal. *Source:* Unknown

Shaft Sets

- Tests initiated at McGill University indicate that a rectangular hollow structural section (HSS) shaft bunton will have 52% of the resistance (to ventilation air) of a standard structural member (I-beam). *Source:* Bart Thompson

Shaft Stations

- At the mining horizon, the nominal interval for shaft stations is between 150 and 200 feet; however, with full ramp access to the orebody this interval can be higher, as much as 400 feet. *Source:* Jack de la Vergne
 - Above the mining horizons, shaft stations are not required for access, but stub stations should be cut at intervals of ± 1,000 feet, because this is a good distance for safely supporting steel wire armored or riser teck power cables. *Source:* Jim Bernas
-

Shaft Stations (continued)

- Above the mining horizons, full shaft stations are not required for access, but intermediate pumping stations are required at intervals not exceeding 2,500 feet (typically 2,000 feet) when shaft dewatering is carried out with centrifugal pumps. They may still be required for shaft sinking and initial development, even though the mine plans for using piston diaphragm pumps for permanent mine dewatering. *Source:* Andy Pitz
- The minimum station depth at a development level to be cut during shaft sinking is at least 50 feet (15m). *Source:* Tom Goodell

Shaft Clearances

- For a fixed guide system employing steel guides, the minimum clearance between a conveyance and a fixed obstruction (i.e. shaft dividers or shaft walling) is 1½ inches for small, square compartments; otherwise it is 2 inches. *Source:* Jack de la Vergne
- For a fixed guide system employing wood guides, the minimum clearance between a conveyance and a fixed obstruction (i.e. shaft dividers or shaft walling) is 2½ inches for small, square compartments; otherwise, it is 3 inches. *Source:* Jack de la Vergne
- For a rope guide system in a production shaft, the minimum clearance between a conveyance and a fixed obstruction is 12 inches and to another conveyance is 20 inches. These clearances may be reduced with the use of rub ropes. *Source:* George Delorme
- The side-to-side clearance between the skip shoes and guides should be designed ¼ inch and should not exceed 3/8 inch in operation. The total clearance face to face of guides should be ½ to 5/8 inches and not exceed ¾ inch. *Source:* Largo Albert

Shaft Spill

- For a well-designed skip hoist installation, the amount of shaft spill will equal approximately ½% of the tonnage hoisted. (This rule of thumb is based on interpretation of field measurements carried out at eight separate mines, where the spill typically measured between ¼% and 1% of the tonnage hoisted.) *Source:* Jack de la Vergne

Timber Shaft

- The classic three-compartment timber shaft employing one hoist for skip and cage service is normally satisfactory for production up to 1,000 tpd, although there are a few case histories with up to twice this rate of production. *Source:* Jack de la Vergne
- For a timber shaft, the minimum dimension of the space between the shaft timber and the wall rock should be 6 inches. *Source:* Alan Provost
- For a timber shaft, set spacing should not exceed 8 feet. *Source:* J.C. McIsaac
- For a timber shaft, catch pits are typically installed every six sets (intervals of approximately 50 feet). *Source:* Jim Redpath

9.3 Tricks of the Trade

- A part of the design for a shaft equipped with conveyances is the orientation of the shaft, which should consider both surface and underground layouts. Normally, a circular shaft has its sets oriented to best suit the desired underground station and loading pocket layouts and the surface structures subsequently oriented to fit. *Source:* Jack de la Vergne
- The old rule that says a vertical shaft should be located 200 feet from the crest of an open pit has been proven invalid by sorry experience. The set back distance should be determined by rock mechanics (and soil mechanics where applicable). *Source:* Jack de la Vergne
- In the case of a deep orebody, it has already been well proven that a twin shaft layout can be used to bring a new mine into a high rate of production at an early stage, which must be the aim of every new mining venture. Sinking two shafts simultaneously also provides desirable insurance against the possibility of one shaft encountering serious sinking difficulties. *Source:* L.D. Browne
- A twin shaft layout for a deep mine that is significantly offset from a single mining horizon will require twin cross cuts to the orebody to complete the ventilation loop. It may be better to set the shafts far apart to provide an efficient ventilation circuit. *Source:* Jozef Stachulak

- Hot dip galvanizing of shaft steel has so far provided the best practical protection from corrosion, when compared with epoxy, coal tar, or polymer based paints. Galvanized steel is not scratch resistant, but this is not required since zinc in the immediate vicinity of the scratch will prevail against the propagation of rust. Source: Jack de la Vergne
- The process of hot dip galvanizing involves temperatures almost identical to the standard procedure for stress relieving. This means that a significant cost saving can be had by purchasing Grade C HSS tubing instead of the more expensive Grade H (stress-relieved). Source: Ron Elliot
- Equipped circular concrete shafts have often been designed with a divider beam between the cage and counterweight. In most cases, this member is not required and represents an unnecessary expense. Source: Jack de la Vergne
- A frequently overlooked item is the large diameter of flanges that may be required for a high-head pump column to fit into a shaft. The flange diameter should be determined at the design stage to avoid later problems. Source: Gord Stewart.
- In the elastic (stiff) rocks found in hard rock mines, horizontal loads on concrete shaft linings are relatively small and never attain the values that occur as lateral loads on lined tunnels. The rock loads themselves (against the concrete shaft lining) may be zero in the case of strong elastic rock formations. Source: Peter Grant
- The concrete lining in a circular shaft is normally subjected only to compressive forces and is alleviated from the effects of shrinkage because of its bond to the wall rock. Hence, in a stable temperature environment, the concrete lining should require no reinforcing steel and normally none is employed. Source: Jack de la Vergne
- The influence of light reinforcing is not taken into account in the stiffness calculation for a concrete lining. Reinforcement, such as mesh in shotcrete or light reinforcing steel in concrete, may play an important role in controlling and distributing stresses and cracks, but it does not significantly increase the stiffness. Source: Hoek and Brown
- The compressive strength of a circular concrete lining may be increased by the addition of reinforcing steel, but this procedure is inefficient. It is normally easier and less expensive to simply employ a higher strength concrete. Source: Witold Ostrowski
- It is convenient to assume that the increase in concrete lining strength due to confinement of the lining is equal to that required for resisting grouting pressures. Therefore, both can normally be ignored in design calculations. Source: Jack de la Vergne
- For a timber shaft, bearing sets are usually placed beneath each station and loading pocket. Source: Jim Redpath
- For a timber shaft, the function of the hanging rods is to assist in hanging and aligning the sets. They do not contribute to the integrity of the permanent installation. Integrity is accomplished with the blocking and bearing sets. Source: Del Anderson

9.4 Function of Concrete Lining in a Circular Shaft

9.4.1 Curb Rings

The first shafts sunk in hard rock mines had no lining. When some were sunk deep, problems developed during the sinking and subsequent operations. These problems were principally related to ground control. The way to overcome this problem was to do what others had already done in mines that had to traverse soft ground formations – sink them circular and line them with masonry. Because it is difficult to lay masonry upside down, the procedure was to pour concrete curb rings at intervals so that the masonry could be laid up between them as the shaft sinking advanced.

9.4.2 Continuous Lining

Following World War II, a procedure was developed in South Africa where the curb ring pour was simply continued up to the next ring. This procedure was used in achieving extraordinary rates of advance and was soon copied elsewhere. In North America, this procedure and the circular shaft section were quickly adopted in hard rock mines to replace the concrete lined rectangular shaft and, in many cases, to replace the traditional rectangular timber shaft.

9.4.3 Role of Lining

For a circular shaft in a hard rock mine, the wall rock is *stiffer* than the concrete so ground stresses are not transmitted to the concrete from the country rock. The only structural role of the concrete is a passive one. The concrete has little effect on the stress distribution in the surrounding strata; however, the concrete can have a considerable effect on the strength of the wall rocks, even if it only stops the development of loose and prevents the wall rock from unraveling or sloughing. This allows the wall rock to continue to support even though fractured. The advance of the concrete lining of a shaft sunk in a hard rock mine is normally kept 2-3 diameters above the advancing shaft bottom to permit relaxation of the wall rock; however, when a hard rock mineshaft encounters bad ground, the lining may be expected to provide active structural support. To maximize this support (by taking advantage of the slight wall closure), the concrete should normally be placed as close to the bottom of the excavation as practical (there are exceptions). Even for purposes of this support, the concrete rarely needs be very thick at all, especially when unavoidable over-break is taken into account.

9.4.4 Concrete Lining Advantages

The concrete lining has other advantages. Perhaps the most important is to provide an anchor for the shaft steel and utility hangers. The regular dimensions of the shaft means that the shaft steel and hardware can be shop-fit to the shaft on an 'assembly line' basis as opposed to field-fitting on a one-of-a-kind basis. Inserts placed in the concrete (using dummy bolts in the shaft forms) eliminate the requirement for drilling anchors to support the hangers for sets and utilities.

Another advantage is that the concrete lining provides a smooth surface for ventilation air. The resistance of a concrete lined ventilation shaft is about ¼ that of a raw raise of the same diameter.

In wet shafts, the concrete lining is of assistance in controlling and collecting the flow of groundwater and provides benefit to dry wall grouting.

9.5 Stiffness of Concrete

The stiffness of concrete (Young's modulus of elasticity, E) to compare with the stiffness of the rock to be sunk through and can be calculated from the following formula.

$$E = 57,000 (f'c)^{1/2}$$

American Concrete Institute, 1977

Example

Find the modulus of elasticity for 3,600 psi (25 MPa) concrete.

Solution: $E = 57,000 (3,600)^{1/2} = 3.4$ million psi (23.5 GPa)

Check calculations Lloyd Rangan formula, $E = 3,320 (f'c)^{1/2} + 6,900$, [values in MPa]

Solution: $E = 16,600 + 6,900 = 23,500$ MPa = 23.5 GPa

9.6 Stiffness of Rock

Minimum and typical values for the stiffness of rocks typically encountered in shaft sinking are tabulated in metric units in the following tabulation (Table 9-1). Hard rocks are normally stiffer than a concrete lining. It should be noted that the values given are for sound rock and do not consider decomposition (degenerative alteration) that may sometimes occur.

Table 9-1 Stiffness of Common Rocks in GPa

(1 GPa = 145,000 psi)

		Minimum	Typical
Igneous	Gabbro and Norite	40	70
	Basalt and Dolerite	40	60
	Andesite	35	55
	Granite	30	50
Metamorphic	Quartzite	50	70
	Gneiss	30	50
	Marble	30	50
	Schist	4	10
Sedimentary	Limestone and Dolomite	20	45
	Sandstone	15	35
	Shale	5	20

9.7 Concrete Liner Design

Concrete liners are not usually “designed” for hard rock applications. As previously explained, the stiffness of the concrete is normally less than the wall rock; therefore, the concrete will not be subjected to ground stress. Conditions do exist where the concrete lining for a hard rock mineshaft must be “engineered.” One common example is the collar of a circular concrete shaft that is sunk in a deep soil overburden. In this case, the concrete liner of the shaft section in overburden is designed to resist the soil pressure and the ground water pressure.

The pressure from ground water (hydrostatic pressure) is readily determined if the maximum height of the ground water table is known. The soil pressure is simple to calculate for granular soils (sand and gravel), but for overburden containing cohesive soils (silts and clays) or a mixture of granular and cohesive soils, determining the design pressure is better left to a soil mechanics expert.

A concrete cylinder subjected to a uniform pressure (radial) around its outer circumference will develop an internal compressive stress tangential to its circumference. If the pressure is applied suddenly, the concrete will react elastically and the stress near the interior wall of the lining will be greatest and gradually reduce towards the outer wall. The formula to be employed for this case is the Lamé or “thick wall” formula.

If the pressure is great and applied slowly, the concrete may react plastically and the stresses will tend to redistribute themselves evenly across the thickness of the concrete wall. A number of formulae have been developed to account for this plastic or visco-elastic property of concrete, the best recognized of which is the Huber formula.

Hard rock miners are more comfortable with the elastic analysis (Lamé) because it is more conservative (safer) and miners find it difficult to imagine that concrete can deform to a plastic condition. Furthermore, miners are not satisfied with the SF employed in concrete design codes for a “dead” load (which may be 1.4). For good reason, miners prefer to use a SF of approximately 2 to design a concrete lining. Miners will not allow a shaft collar lining less than 18 inches (450mm) thick.

For the design of the liner shaft collar in deep overburden, it is wise to assume the ground water table is at surface elevation and/or that (to account for arching) at least 70% of the maximum theoretical active soil pressure is applied throughout the total height of the collar.

$$t = r \cdot \left(\left[\frac{f'c/F}{f'c/F - 2p} \right]^{1/2} - 1 \right)$$

Lamé Formula

$$t = r \cdot \left(\left[\frac{f'c/F}{f'c/F - \sqrt{3} \cdot p} \right]^{1/2} - 1 \right)$$

Huber Formula

Example (Imperial Units)

Determine the required concrete thickness for the lining of a circular concrete shaft subjected to external pressure using the Lamé formula.

- Facts:
1. The circular concrete shaft has a 20-foot inside diameter
 2. The circular concrete shaft is subjected to an external pressure of 200 psi
 3. The concrete is to have a 28-day strength of 3,500 psi

- Solution:
1. $f'c = 3,500$ psi = UCS of the concrete
 2. $F = 2.0 = SF$ with respect to compressive strength of concrete.
 3. $P = 200$ psi = external pressure
 4. $r = 120$ inches = inside radius of the circular shaft
 5. $t = ? =$ thickness required measured in inches

$$t = 120 \cdot \left(\left[\frac{1750}{1750 - 400} \right]^{1/2} - 1 \right) = 16.6 \text{ inches (use 18 inches)}$$

Example (Metric Units) (same problem with comparable values):

Determine the required concrete thickness for the lining of a circular concrete shaft subjected to external pressure using the Lamé formula.

- Facts:
1. The circular concrete shaft has a 6.1m inside diameter
 2. The circular concrete shaft is subjected to an external pressure of 1,400 kPa
 3. The concrete is to have a 28-day strength of 25 MPa

Solution:

1. $f'c = 25$ Mpa= UCS of the concrete
2. $F = 2.0 = SF$ with respect to compressive strength of concrete.
3. $p = 1400$ kPa = external pressure
4. $r = 3050$ mm = inside radius of the circular shaft
5. $t = ? =$ thickness required measured in millimeters

$$t = 3050 \cdot \left(\left[\frac{12.5}{12.5 - 2.8} \right]^{1/2} - 1 \right) = 412\text{mm (use 450mm)}$$

Example (Check Calculations)

Determining the ultimate strength (implosion pressure), P_{ult} of the thickness designed and comparing it to the design pressure provides a SF based on the ratio of these values. Checking the design calculation may be worthwhile by employing the Haynes formula (empirical) in the following form.

$$P_{ult} = f'c (2.17t/D_o - 0.04), \text{ in which } D_o = \text{outside diameter of the lining}$$

$$P_{ult} = 25 (0.14 - 0.04) = 2.5 \text{ MPa} = 2,500 \text{ kPa}$$

$$\text{Safety factor with respect to ultimate strength} = 2,500/1,400 = 1.8$$

9.8 Steel Liner Design

Besides the standard monolithic concrete liner, three additional types of shaft liners exist, each incorporating a steel plate into its design.

- Steel plate and concrete composite (“sandwich liner”)
- Perforated steel liner (“leaky liner”)
- Steel hydrostatic liner (water-tight)

9.8.1 Sandwich Liner

The sandwich liner takes advantage of the strength of steel and the inertia of the concrete. For the composite to act together, there should be a near equality of the ratios of strength to stiffness for each of the components. Shear connectors (similar to the “Nelson studs” used in bridge construction) help ensure composite action. These liners are rarely encountered and are yet to be applied to a hard rock mineshaft, so are not discussed further.

9.8.2 Leaky Liners

Leaky liners have occasional application where the wall rock of the shaft (or raise) must be kept from unraveling. Upon installation, the annulus between the liner and the rock is filled, normally with pea gravel. The perforations ensure that no pressure builds up due to ground water. The design of the leaky liner need only concern the minimum thickness required for handling. This aspect (handling) is not as severe a problem as it is for the hydrostatic liner. A plate thickness equal to the radius/144 (PG&E formula) is normally satisfactory.

9.8.3 Hydrostatic Liner

The steel hydrostatic liner (HSL) has a number of applications in hard rock mine shafts that have a horizon of running ground above the orebody or severe groundwater conditions. A "big-hole" rig equipped for reverse circulation drilling is employed to drill the shaft in one pass. The procedure temporarily supports the ground with a heavy drilling fluid ("mud") that contains additives such as bentonite and barite. Upon the completion of the drilling, the hole is left full of fluid and the hydrostatic lining (sealed at the bottom with a hemi-spherical plate section) is "floated" into it. The first length of HSL casing ("can") is filled with water until it has sunk far enough that the top is just above collar level. Then, the second can is welded to it and in turn filled with water to make it sink further. This procedure is repeated until the liner has reached the bottom of the shaft. The HSL is then grouted into place through small pipes on the outside that are retracted towards surface as the annulus is filled with cement grout. Finally, the liner is pumped dry and the bottom seal opened up to the mining horizon.

This method of shaft drilling and lining was first developed at Los Alamos, New Mexico for the purpose of detonating hydrogen bombs. The deepest HSL application was for the 7,000-foot (2,133-m) shaft drilled on Amchitka Island in Alaska during the Nixon administration. The steel hydrostatic liner for this shaft had no stiffening rings on the lower cans because the plate thickness required to resist compression from the hydrostatic pressure at that depth was already sufficient to resist buckling.

Hydrostatic Liner Design

The typical hydrostatic liner consists of a cylindrical steel shell reinforced with stiffening rings. The shell is designed for compressive strength and the rings provide added resistance to buckling. Mild steel is recommended because it is the least affected by residual stresses.

Since it makes little difference anyway, it is accepted practice to assume the ground water table is at surface (shaft collar elevation). The hydrostatic pressure (design pressure) is equal to a water column of height equal to the distance between any reference elevation of the lining and the shaft collar. It is precisely 62.43 Lbs. per square foot/foot of depth (imperial system) or 9.807 kPa/m (metric system).

No official standards or guidelines exist for the design of these mineshaft liners. The following procedure was developed in a technical paper¹ that, in turn, drew upon recognized procedures developed for the design of industrial pressure vessels, ocean-going drill rig platform legs and submarines.

The procedure is to first design the shell thickness required to resist the hydrostatic pressure, employing a suitable factor of safety (refer to the rules of thumb at the beginning of the chapter). The plate thickness required for each "can" is thus determined. The thickness is increased at shallow depths to meet the minimum required for handling. The "critical" depth with respect to general instability (total collapse) is then determined and a suitable ring spacing (that is an even division of the can length) calculated. With this spacing determined, the width of the ring itself (for this elevation) is determined, assuming a maximum practical height of the ring (normally 4 inches). The rings are designed to go on the outside of the shell to facilitate fabrication and to provide a smooth-walled shaft suitable as a ventilation airway. The placement conditions of the liner require a rugged design. For this reason, the liners consist of solid bands of steel, rectangular in cross-section. (Inverted channel sections as used on pressure vessels have proven unsuitable by sorry experience.) In the ring design, a portion of the adjacent shell is assumed to act with the ring in providing stiffness by reason of their combined moment of inertia. For this reason, the rings (bands of steel) are wrapped snug around the shell and firmly welded to it. It is convenient to continue the ring spacing, once established, throughout. Finally, the design is checked for the possibility of local buckling (between the rings) and for each can the ring size is adjusted as required.

¹ de la Vergne and Cooper, *A Simplified Procedure for the Design of the Full Hydrostatic Steel Mine Shaft Liner*, SME Transactions, Vol. 274, 1983

9.9 Shaft Design Tolerances

Following are typical tolerances permitted for shaft sinking and drilling contracts.

Timber Shafts

Set to set distance	$\pm 1/2$ inch
Sets	$\pm 1/8$ inch
Face to face of guides	$\pm 1/8$ inch
Clearance to wall rock	6-inch to 24-inch
Overbreak	Blocks exceeding 24 inches in length to be pinned to the wall rock

Concrete Shafts (with steel sets)

Concrete forms (circumference)	- $1/4$ / +0 inch
Concrete lining (out of plumb)	$\pm 1/2$ inch
Set to set distance	$\pm 1/4$ inch (but not allowed to be cumulative)
Sets	$\pm 1/8$ inch
Face to face of guides	$\pm 1/16$ inch
Minimum concrete thickness	6 - 9 inches (typical overbreak is 9 – 12 inches)

Drilled Shafts (with steel hydrostatic liners)

Drilled Shaft (out of plumb)	$\pm 1/2$ hole diameter
Liner shell (out of round)	$\pm 1/4\%$ of diameter (or as determined by analysis)

10.0 Shaft Sinking

"Now when a miner finds a vena profunda, he digs a shaft collar, sets up a hoist, and builds a headframe.... Then a shaft is sunk, 10 feet long by three and one-half wide."

Georgius Agricola, 1556

10.1 Introduction

Of all the headings driven in hard rock mines, shafts are the most costly and time consuming. Moreover, the shaft sinking procedure is intricate and arduous.

While a few shafts are advanced by big-hole drilling methods, the great majority employs the traditional "drill and blast" cycle to which this chapter is devoted.

In North and South America, shafts for smaller mines are traditionally sunk rectangular and rely on timber for support. Larger mines typically employ circular shafts lined with concrete poured in place as the sinking advances.

Today, independent mining contractors sink most shafts. While there have been significant technical advances, no world records have been broken for rate of shaft-sinking advance in hard rock since 1962. Part of the problem is that mining contractors have no discretionary funds to invest in research and development, while mining companies and government agencies have other priorities for what little resources are available.

Except at great depth, shafts sunk in hard rock mines do not normally require special considerations to maintain wall stability. A few shafts require the ground freezing method to traverse a water-bearing horizon (discussed separately in Chapter 12 – Collars and Portals).

10.2 Rules of Thumb

Schedule

- From time of award to the start of sinking a timber shaft will be approximately five months. A circular concrete shaft may take three months longer unless the shaft collar and headframe are completed in advance. *Source:* Tom Anderson
- The average rate of advance for shaft sinking will be two-thirds of the advance in the best month (the one everyone talks about). *Source:* Jim Redpath

Hoist

- The hoist required for shaft sinking needs approximately 30% more horsepower than for skipping the same payload at the same line speed. *Source:* Jack de la Vergne
- Without slowing the rate of advance, a single drum hoist is satisfactory to sink to a depth of 1,500 feet at five buckets per foot, 2,000 feet at four buckets per foot, and 2,500 feet at 3½ buckets per foot. For deeper shafts, a double-drum hoist is required to keep up with the shaft mucker. *Source:* Jack de la Vergne

Bucket

- For sinking a vertical shaft, the bucket size should be at least big enough to fill six for each foot of shaft to be sunk; five is better. *Source:* Marshall Hamilton
 - For the bucket to remain stable when detached on the shaft bottom, its height should not exceed its diameter by more than 50%. *Source:* Jim Redpath
 - Tall buckets can be used safely if the clam is used to dig a hole in the muck pile for the buckets. *Source:* Bill Shaver
 - A bucket should not be higher than 7½ feet for filling with a standard *Cryderman* clam (which has an 11-foot stroke). *Source:* Bert Trenfield
 - A bucket should not be higher than 6 feet when mucking with a 630, which has a 6-foot-6-inch discharge height. *Source:* Alan Provost
 - You can load a tall bucket using a 630 if you slope the muck pile so that the bucket sits at an angle from the vertical position. *Source:* Fern Larose
-

Bucket (continued)

- In a wet shaft, the contractor should be able to bail up to 10 buckets of water per shift without impeding his advance. *Source:* Paddy Harrison

Water Pressure

- For any shaft, the water pressure reducing valves should be installed every 250 feet. “Toilet tank” reducers are more reliable than valves and may be spread further apart. *Source:* Peter van Schaayk
- Water pressure reducing valves may be eliminated for shaft sinking if the water line is slotted and the drill water is fed in batch quantities. *Sources:* Allan Widlake and Jannie Mostert

Compressed Air

- One thousand cubic feet per minute (cfm) of compressed air is needed to blow the bench with a two-inch blowpipe. *Source:* Bill Shaver
- Twelve hundred cfm of compressed air is needed to operate a standard Cryderman clam properly. *Source:* Bill Shaver

Shaft Stations

- The minimum station depth at a development level to be cut during shaft sinking is 50 feet. *Source:* Tom Goodell
- A shaft station will not be cut faster than 2,000 cubic feet per day with slusher mucking. It may be cut at an average rate of 3,500 cubic feet per day with an LHD mucking unit. *Source:* Jim Redpath

Circular Shaft

- The minimum (finished) diameter of a circular shaft for bottom mucking with a 630-crawler loader is 18 feet. *Source:* Tom Goodell
- With innovation (use a tugger), a 15-foot diameter shaft can be mucked with a 630 crawler-loader. *Source:* Darrel Vliegenthart
- For a circular concrete shaft, the minimum clearance between the sinking stage and the shaft walls is 10 inches. *Source:* Henry Lavigne
- A circular concrete lined shaft sunk in good ground will have an average overbreak of 10 inches or more, irrespective of the minimum concrete thickness. *Source:* Jim Redpath
- For a rope guide system in a shaft being sunk to a moderate depth, the minimum clearance between a conveyance (bucket and crosshead) and a fixed obstruction is 12 inches and to another bucket is 24 inches. At the shaft collar, the clearance to a fixed obstruction may be reduced to 6 inches due to slowdown, or less with the use of fairleads or skid plates. In a deep shaft, 18-24 inches is required to clear a fixed obstruction and 30-36 inches is required between buckets, depending on the actual hoisting speed. These clearances assume that the shaft stage hangs free and the guide ropes are fully tensioned when hoisting buckets. *Various Sources*
- When hoisting at speeds approaching 3,000 fpm (15m/s) on a rope guide system, the bonnet of the crosshead should be gridded instead of being constructed of steel plate to minimize aerodynamic sway. *Source:* Morris Medd
- The maximum rate at which ready-mix concrete will be poured down a 6-inch diameter slick line is 60 cubic yards per hour. *Source:* Marshall Hamilton
- To diminish wear and reduce vibration, the boot (“velocity killer”) at the bottom end of the concrete slick line should be extended in length by 6 inches and the impact plate thickened by one inch for each 1,000 feet of depth. *Source:* R. N. Lambert

Timber Shaft

- For a timber shaft, the minimum clearance to the wall rock outside wall plates and end plates should be 6 inches; the average will be 14 inches in good ground. *Source:* Alan Provost
 - For a timber shaft that encounters squeezing ground, the minimum clearance outside wall plates and end plates should be 12 inches. *Source:* Dan Hinich
 - For a timber shaft, the blocking should not be longer than two feet without being pinned with rock bolts to the wall rock. *Source:* Jim Redpath
-

10.3 Tricks of the Trade

- For a circular concrete shaft, the bigger the bucket, the better. Source: Jim Redpath
- A bail of a shaft sinking bucket built from four chains and paired on each side permits smoother dumping and requires less overwind clearance in the headframe than does the typical three-chain bail. Sources: Fern Larose and Gabriel Juteau
- If the pull cord system fails, shaft signals can be transmitted between the collar and a sinking bucket or the Galloway stage at the shaft bottom by tapping on a steel pipe in the shaft. Source: Jack Brooks
- In an emergency, fresh concrete may be prevented from setting solid by mixing in several bags of ordinary sugar kept on site in case of such an event. Source: Jim Redpath
- To reduce segregation of concrete poured down a slick line, "grease" the line with half a ready-mix truckload of grout before starting the pour. Source: Bob Dengler
- The most practical way to handle the unavoidable segregation of concrete poured down a slick line is to wet the empty line and then direct the first concrete to the shaft bottom. After less than one cubic yard is wasted, the shaftmen can plainly see that segregation has ceased and direct the remainder of the pour into the forms. Source: Tom Goodell
- With the long shaft rounds used today, the average overbreak will be 12-14 inches, unless perimeter drilling and smooth-wall blasting is employed. Source: Jack de la Vergne
- Ready mixed concrete for a shaft (or tunnel) lining is not cheap, but what's really expensive is the cost of delays due to a short order or removal of tight (underbreak). Source: Darrel Vliegthart
- A small circular concrete shaft can be slashed successfully on a raisebored hole as small as 4 feet diameter when hand-held sinker drills are employed. Source: Bob Hendricks
- A shaft of large diameter employing a long-steel drill jumbo is better slashed on a raisebored hole of 8-10 feet diameter. Source: Bill Shaver
- Horsepower demanded by the shaft-sinking hoist is greatest at the start of the sink and slowly decreases until a great depth has been reached. This is one reason not to be overly concerned about a hoist motor running hot at the onset of shaft sinking. Source: Bob Pronovost
- If an AC hoist motor overheats while sinking and equipping a concrete shaft in one pass, the problem is often traced to the long creep from the lower chairs to the galloway caused by leaving the shaft equipping too far behind. Source: Jack de la Vergne
- If a hoist motor stalls when lifting a full bucket off the bottom, the problem can often be traced to voltage drop. The torque of an AC motor varies with the square of the voltage. A 10% loss in voltage results in a 21% reduction in torque and hence rope pull. Source: Jarvis Weir
- A hoist satisfactory for shaft sinking will invariably have sufficient capacity to subsequently hoist the muck from pre-production development. Source: Jack de la Vergne
- One good location for the stage winches is in the sub-collar. The winches can be arranged to pay the rope directly down the shaft or, if necessary, deflected with a Teflon slide thereby removing the requirement for head sheaves and problems with fleet angles. The bucket cross heads ride on the return ropes (two parts of line), which are anchored high in the headframe. Source: Bert Trenfield
- A good way to ensure that the galloway stage hangs plumb is to employ four stage winches, each with one part of line. The four ropes are arranged offset at an angle from the shaft centerline to provide guides for the shaft buckets. Sources: Doug McWhirter and Vic Whalen
- The best way to ensure that the galloway stage hangs plumb is to employ three stage winches, each with two parts of line. The ropes are located at the stage in a manner that provides equal weight distribution to each rope. Source: Jim Tucker
- The doors on a galloway stage (required to pass the vent duct when hoisted to clear for a blast) are better built of aluminum to facilitate manhandling. Source: Tony Campbell
- Corrosion of stage ropes is inhibited by employing zinc bushings in addition to, or instead of, the normal HDP plastic bushings on the crosshead attachment. Source: OML (Ontario Ministry of Labor, Mines Branch)
- The best way to hang rigid vent duct when shaft sinking to moderate depths is to install an extra tigger hoist or small winch on the surface, the rope from which hangs inside the string of duct already in place. It is then a simple matter to thread the rope down through a section of duct to be installed and hoist it neatly into place for fastening. Source: Bert Trenfield

- In a frozen shaft, the easy way to anchor a rock pin required to support screen on the shaft walls is to drill the pin hole slightly downwards and fill the annulus with plain water poured from an oil can after the pin is inserted. *Source:* Herb Fredrickson
- When de-stressing is required for a deep shaft, long drill holes are loaded and sprung (toe-blasted). The best stemming (to prevent rifling) is water poured into the drill hole. *Source:* John Stevenson
- Deep shafts employing hydraulic drills only need compressed air for mucking, rock bolt holes, and cleaning the bottom. This means that a large compressed air plant is virtually idle throughout a large portion of the cycle time. This spare capacity can be put to use very easily by using air as a refrigerant and providing a standard expansion valve to cool service water required for drilling, etc. before resorting to air conditioning. *Source:* Jack de la Vergne

10.4 Types of Shafts

Shafts sunk today in hard rock mines are mostly limited to the standard three-compartment timber shaft and the circular concrete shaft.

The standard three-compartment timber shaft has two hoisting compartments that measure six feet by six feet inside the timbers. The third compartment, used for a manway and utilities, is sometimes slightly shortened from the six-foot width. These timber shafts are still contemplated for exploration entries in general and production shafts for small hard rock mines. For remote sites, the shaft timber may be replaced with steel sets to save on weight and the cost of transportation. It is now widely believed that any savings thus realized are later lost in the shaft sinking costs and schedule, mainly due to the increased difficulty in installing blocking (which cannot be nailed), catch pits, and launders (water rings). In addition, omission of hanging rods makes the sets more difficult to hang and align. Although a number of ingenious methods have been developed for timber shafts to successfully traverse bad ground conditions (jacket sets, pony sets, squeeze blocking, etc.), timber shafts are no longer considered when bad ground or highly stressed ground is anticipated. In North America, suitable timber has become scarce and expensive. For this and other reasons, shaft sinking by this method is now mainly confined to deepening existing timber shafts.

The circular concrete shaft, sunk vertical, is invariably employed for large shafts and most often employed for any deep shafts. The circular shafts may be as little as 12 feet in diameter for shallow applications, but deep shafts are better tooled for shaft sinking if they are of larger diameter. At hard rock mines, only a few shafts of appreciable depth have been sunk larger than 26 feet in diameter outside of South Africa.

For additional information on shaft types and design considerations, please refer to Chapters 1 and 9 of this handbook.

10.5 Planning and Preparations – Recipe for Success

Today, contractors sink most mineshafts; however, this does not relieve the owner of significant responsibilities. An interesting statistic reveals that most large mining companies, long experienced with shaft sinking, are invariably successful with new projects, as would be expected. On the other hand, there are a few of these companies that are rarely successful, no matter which contractor they select. It is also notable that deep civil shafts seldom achieve satisfactory advance rates. (Shafts sunk in France for atomic waste isolation facilities provide a striking example of what not to do.) Following is a list of tasks and procedures suggested as the basis for a successful shaft-sinking strategy.

- Appoint one individual (project manager) at the outset to direct the work.
- Appoint a small advisory committee to help the project manager with planning.
- Engage an outside individual expert to join the planning group.
- Perform a search of comparable shaft-sinking projects.
- Make site visits to comparable sinking projects already in progress.
- Enter into a dialogue with potential contractors to review the shaft design and provide advance notice of the project.
- Make a list (similar to this one, but more comprehensive) appropriate to the particular project requirements.
- Pre-qualify potential contractors to a short list of five or less.
- Locate the shaft collar on high ground, not in a natural watercourse.
- Provide adequate survey monuments and benchmarks.
- Drill and log a shaft pilot hole and provide a formal report to be included with the contract tender documents.
- Consider slim-line grouting from the pilot hole where ground water is encountered.
- Allocate a budget cash flow that can accommodate better than anticipated performance by the contractor.

- Pre-grout the shaft collar to provide an impervious curtain around its perimeter.
- Consider inclusion of a sub-collar in the shaft design.
- Review the contract documents to ensure that the risks are shared appropriately between owner and contractor.
- Consider a contract clause that rewards good advance and safety record by the contractor with a financial incentive (bonus).
- Limit penalties for poor performance to a modest amount, or none at all.
- Ensure that the contract documents fully accommodate a breach or bankruptcy requiring a changeover to a new contractor after the work is in progress.
- Ensure that the tender call period is adequate (usually six weeks is appropriate).
- Ensure that there are outside accommodations available for contractor's personnel within a twenty-minute drive of the work, otherwise consider a bunkhouse or trailer park at the site.
- Provide for a separate dry facility (changehouse) adjacent to the shaft.
- Appoint an appropriate team on site to assist the project manager in administering the sinking contract, including a geologist, shaft inspector, and procurement officer.
- Ensure there are adequate office facilities for the field management team.
- Have the contract between owner and contractor signed before the work is well underway.
- Crack down on quality control at the outset of the work.
- Limit visits in the shaft to the appropriate part of the sinking cycle.

10.6 Hoist Selection for Shaft Sinking

Table 10-1 identifies the size of a double-drum hoist satisfactory to sink a typical shaft at an acceptable rate of advance.

Table 10-1 Selection (diameter) of Double-Drum Hoist for Shaft Sinking

Shaft Depth	Standard Three-Compartment Timber Shaft	Inside Diameter of Circular Concrete Shaft (feet)					
		14	16	18	20	22	24
1,000 feet	5'Ø	6'Ø	6'Ø	8'Ø	8'Ø	10'Ø	10'Ø
2,000 feet	6'Ø	8'Ø	8'Ø	8'Ø	10'Ø	10'Ø	10'Ø
3,000 feet	8'Ø	8'Ø	8'Ø	10'Ø	10'Ø	10'Ø	10'Ø
4,000 feet	8'Ø	8'Ø	10'Ø	10'Ø	10'Ø	10'Ø	12'Ø
5,000 feet	-	-	10'Ø	10'Ø	12'Ø	12'Ø	14'Ø
6,000 feet	-	-	-	12'Ø	12'Ø	14'Ø	14'Ø
7,000 feet	-	-	-	12'Ø	14'Ø	14'Ø	16'Ø
8,000 feet	-	-	-	-	-	16'Ø	16'Ø

10.7 Shaft Concrete

The ready-mix concrete required for the shaft lining is lowered in the shaft by one of two means:

- Concrete bucket (similar to those used in surface construction), or
- Slick line (a vertical pipe that is extended as the shaft deepens).

The slick line was first used in South Africa to enable concrete to be poured at the same time that the shaft bottom is mucked out. There, the concrete mix was adjusted to have a smaller coarse aggregate size for it to flow freely in a six-inch diameter pipe installed with flanged connections. The problem of segregation was largely overcome by installing a boot ('velocity killer') at the pipe bottom that provides some re-mixing of the concrete. Today, the flanges are replaced with Victaulic® style "low-profile" couplings and, in some cases, the slick line diameter is increased from 6 to 8 inches to accommodate a larger aggregate size.

The following two characteristics of concrete dropped down a slick line should be noted.

- As a slug of concrete falls, it creates a vacuum behind it that sucks out moisture explaining why the slump (measured at the collar) is reduced at the shaft bottom.
- As the concrete drops, its loss of potential energy is converted to heat explaining why the temperature of the concrete (measured at the collar) is increased at the shaft bottom.

Shaft contractors today are divided in opinion as to which method is best to use. In hard rock mines, the concrete quality is normally not critical (refer to Chapter 9 - Shaft Design) and so the slick line is usually satisfactory. An important consideration is that the slick line may later become very useful to the mine. A slick line may be desired to deliver ready-mix concrete or shotcrete mix required for initial and ongoing construction underground after the shaft is sunk.

A common misconception is that the slick line must be hung perfectly vertical. The slick line must be installed perfectly straight and the easiest way to do this is to hang it vertically with plumb lines. When a slick line is installed (or partly replaced) in an already existing shaft, the procedure is to align the pipe column with straight lines anchored at each end, not with plumb lines.

10.7.1 Coriolus Effect

The ready-mix concrete (that free-falls in the slick line) does not tend to fall perfectly vertically; instead it rubs against the East wall of the pipe due to Coriolus effect (the tangential velocity of the earth due to rotation is greater at the shaft collar than it is deep in the mine). While this phenomenon is not significant to placement of a slick line, it confirms that perfect verticality is not a requirement. The Coriolus effect is important in other aspects of mining (such as drift of tailropes and dropping material down a vertical raise or borehole). The drift, x off the vertical is easily calculated with the following formula:

$$x = 2/3 w[2h^3/g]^{1/2} \cos\gamma$$

In which

x = Horizontal drift, meters

w = angular velocity of the earth, radians/second

h = depth dropped, meters

g = acceleration of gravity, meters/sec/sec

γ = □Latitude of the minesite, degrees

10.8 Solved Problems

10.8.1 Coriolus Effect

Example

Find the drift, x , off the vertical of an object dropped in an open shaft when it reaches a depth of 300m (1,000 feet) below the collar.

- Facts:
1. The angular velocity of the earth, $w = 0.0000729$ r/s
 2. The depth dropped, $h = 300$ m
 3. The Latitude at the minesite = 48 degrees N

Solution:

$$x = 2/3 \times 0.0729 [2 \times 300^3/9.81]^{1/2} \cos 48^\circ = 76\text{mm (6 inches)}$$

10.8.2 Overbreak Measurement

Example One

Find the concrete volume.

- Facts:
1. The shaft has a 20-foot inside diameter
 2. The minimum lining thickness will be 12 inches
 3. Overbreak will be 10 inches

Solution: $V/\text{foot} = \pi/27[R_2^2 - R_1^2] = \pi/27[11.83^2 - 10^2] = 4.65$ cubic yards/foot

Example Two

Find the average overbreak.

- Facts:
1. 78 cubic yards of concrete was poured for a 16-foot lift
 2. The shaft is 20-foot diameter
 3. A minimum of 12 inches of concrete is required

Solution: $\text{Overbreak} = [R_1^2 + V/\pi H]^{1/2} - (R_1 + t)$
 $= [100 + (78 \times 27/16\pi)]^{1/2} - 11$
 $= 11.91 - 11 = 0.91\text{ft} = 10.9$ inches

11.0 Lateral Development and Ramps

11.1 Introduction

For underground hard rock miners, the term “lateral development” means the horizontal headings in a mine, such as the drifts and cross cuts at a mine level. Lateral development includes the inclined headings (ramps and declines) between levels. Because it constitutes by far the major portion of mine development, lateral development is of significant consequence.

Pre-production mine development concerns are well recognized by the mining community (and discussed in other chapters of this handbook). Ongoing development during operations is not given similar attention. Part of the reason is that the major portion of the development costs in an operating mine are capitalized and not accounted for in mining costs statements. As a result, the significance of ongoing lateral development is partially disguised.

Despite significant efforts directed at developing new equipment, techniques, and procedures, the productivity and advance rates of lateral development have shown no significant gain during the past twenty-five years. Part of the reason is that most research and development efforts have been directed at modifying mechanized equipment, such as the tunnel boring machine (TBM), continuous miner (gathering arm mucking unit), and the road header. Such machinery is capable of achieving acceptable advance rates in hard rock; however, other problems remain unresolved. These include dealing with high silica dust counts, poor visibility, low cutter wear life, squeezing ground, highly stressed ground, difficult equipment access, poor equipment mobility, difficulty in mechanizing ground support, and inflexibility with respect to gradient and curvature.

As a result, the traditional drill and blast method remains the least expensive and most practical means of advancing lateral headings. For this reason, the balance of this chapter is primarily devoted lateral headings driven by drill and blast.

No universally accepted standard definitions exist for terms that refer to inclined lateral headings. In this chapter, a “ramp” is a heading containing horizontal curves used as a transport corridor for rubber-tired mobile equipment. A “decline” is a straight heading suitable for installation of a belt conveyor that may also permit travel of mobile equipment.

11.2 Rules of Thumb

General

- Laser controls should be used in straight development headings that exceed 800 feet (240m) in length. *Source: Tom Goodell*

- The overall advance rate of a lateral drive may be increased by 30% and the unit cost decreased by 15% when two headings become available. *Source: Bruce Lang*

- The overall advance rate of a lateral drive will be increased by 2m/day when a second heading becomes available and an additional 2m/day with a third heading. *Source: Steve Flewelling*

Trackless Headings

- Approximate productivity for driving trackless headings (drill, blast, scale, muck and bolt) is as follows: 0.3-0.5m/manshift for a green crew; 0.7-0.8m/manshift for competent crews; and 1.0-1.25m/manshift for real highballers. *Source: Robin Oram*

 - The minimum width for a trackless heading is 5 feet wider than the widest unit of mobile equipment. *Source: Fred Edwards*

 - The back (roof) of trackless headings in hard rock should be driven with an arch of height equal to 20% of the heading width. *Source: Kidd Mine Standards*

 - The cost to slash a trackless heading wider while it is being advanced is 80% of the cost of the heading itself, on a volumetric basis. *Source: Bruce Lang*

 - For long ramp drives, the LHD/truck combination gives lower operating costs than LHDs alone and should be considered on any haul more than 1,500 feet in length. *Source: Jack Clark*

 - LHD equipment is usually supplemented with underground trucks when the length of drive exceeds 1,000 feet. *Source: Fred Edwards*

 - With ramp entry, a satellite shop is required underground for mobile drill jumbos and crawler mounted drills when the mean mining depth reaches 200m below surface. *Source: Jack de la Vergne*
-

Trackless Headings (continued)

- With ramp and shaft entry, a main shop is required underground when the mean mining depth reaches 500m below surface. *Source: Jack de la Vergne*
- A gradient of 2% is not enough for a horizontal trackless heading. It ought to be driven at a minimum of 2½% or 3%. *Source: Bill Shaver*
- Wet rock cuts tires more readily than dry rock. To prevent ponding and promote efficient drainage, trackless headings should be driven at a minimum gradient of 2½ - 3%, if at all possible. *Source: John Baz-Dresch*
- The minimum radius of drift or ramp curve around which it is convenient to drive a mobile drill jumbo is 75 feet. *Source: Al Walsh*
- For practical purposes, a minimum curve radius of 50 feet may be employed satisfactorily for most ramp headings. *Source: John Gilbert*
- The gathering arm reach of a continuous face-mucking unit should be 2 feet wider than the nominal width of the drift being driven. *Source: Jim Dales*
- Footwall drifts for trackless Blasthole mining should be offset from the ore by at least 15m (50 feet) in good ground. Deeper in the mine, the offset should be increased to 23m (75 feet) and for mining at great depth it should be not less than 30m (100 feet). *Source: Jack de la Vergne*
- Ore passes should be spaced at intervals not exceeding 500 feet (and waste passes not more than 750 feet) along the draw point drift, with LHD extraction. *Source: Jack de la Vergne*
- The maximum practical air velocity in lateral headings that are travelways is approximately 1,400 fpm (7m/s). Even at this speed, a hard hat may be blown off when a vehicle or train passes by. At higher velocities, walking gets difficult and road dust becomes airborne. However, in pure lateral airways, the air velocity may exceed 3,000 fpm. *Various Sources*
- The limiting air velocity for decline (ramp) truck haulage is 6m/s (1,200 fpm). *Source: McCarthy and Livingstone*
- In practice, the maximum air velocity found employed in lateral headings used for two-way trackless haulage seldom exceeds 1,000 fpm (5m/s). *Source: Derrick May*
- The typical range of ventilation air velocities found in a conveyor decline or drift is between 500 and 1,000 fpm. It is higher if the flow is in the direction of conveyor travel and is lower against it. *Source: Floyd Bossard*
- The maximum velocity at draw points and dumps is 1,200 fpm (6m/s) to avoid dust entrainment. *Source: John Shilabeer*

Track Headings

- Track gage should not be less than ½ the extreme width of car or motor (locomotive). *Source: MAPAO*
- The tractive effort, TE (Lbs.) for a diesel locomotive is approximately equal to 300 times its horsepower rating. *Source: John Partridge*
- Wood ties should have a length equal to twice the track gage, be at least ¼ inch thicker than the spike length, and 1 3/8 times spike length in width. *Source: MAPAO*
- Typical gradients for track mines are 0.25% and 0.30%. *Source: MAPAO*
- A minimum clearance of three feet should be designed between the outside of the rails and the wall of the drift to permit safe operation of a mucking machine when driving the heading. *Source: MAPAO*

11.3 Tricks of the Trade

- Compared with LHDs used for haulage, underground trucks have longer life and carry more tons per horsepower with lower maintenance costs, lower tire costs, and higher availability. *Source: Jack Clark*
- When an underground haul truck is stuck or hung up, place blocking behind it and raise the box just enough to lift the rear wheels. *Source: Bill Middleton*
- Haulage ramps should be widened on curves by 600mm (2 feet) for 50-tonne capacity trucks to prevent damage to vehicle and utility lines at high-speed travel. *Source: Tom Lamb*

- If the back of a heading is secured with split set rock bolts, screen is easily applied by using smaller diameter “utility” split sets that are driven inside the existing bolts to a depth of 18 inches (0.45m). *Source:* Towner and Kelfer
- The gradient of a trackless haulage ramp (decline) should be decreased at intersections to save the differentials on four-wheel-drive mobile equipment making a turn. *Source:* Ken Hill
- Internal ramps are better laid out in a figure eight or oval configuration. Spiral (corkscrew) ramps are difficult to survey, provide less advance warning of oncoming traffic, continually scruff the tires of mobile equipment, and make roadway grading difficult. *Source:* Menno Friesen
- Where it is not practical to design a curve at a location that will experience only occasional traffic, remember that LHD equipment is bi-directional, so a switchback may be employed instead. *Source:* Bill Middleton
- In some jurisdictions, a long ramp drive requires in-line run away safety bays. These may be built at modest cost by first using the safety bay as a muck bay (that is usually required anyway), then subsequently filling the bay with empty oil drums to cushion impact. *Source:* Ross Gowan
- The advance rate of a lateral heading may be significantly improved by using a side-dump crawler mounted loader to fill haul trucks at the face. *Source:* John Newman
- When the heading is at least 20 feet (6m) wide, a lateral drive may be better served with a skid mounted gantry jumbo (drive-through) rather than the typical mobile drill jumbo. The gantry is easily moved to another face by lifting and hauling it with the bucket of an LHD or the box of a haul truck. *Source:* Ron Vaananen
- It should be considered that a high back is difficult to scale and keep safe. It may be better to dispense with arching and drive with a flat back when ground conditions permit. *Source:* Douglas Duke
- In burst prone ground, top sills are driven simultaneously in a chevron (“V”) pattern. Outboard sills are advanced in the stress shadow of the leading sill with a lag distance of 24 feet. *Source:* Luc Beauchamp
- Front-end loaders are excellent for mucking but poor for haulage; LHD units are designed to perform both functions but do not perform either of them really well. *Source:* Ron Vaananen
- One practical means of obtaining road dressing underground at the size desired (-1½ inches) is to install a tuning fork grizzly (or similar device) at a suitable location to divert a portion of the undersize material in the waste rock stream for use as roadbed dressing. *Source:* John Gilbert and Jack de la Vergne
- When the floor of a ramp heading is to be paved with monolithic concrete to handle heavy traffic loads, it must be cleaned to the rock surface before pouring concrete. Otherwise, the pavement will fail due to the pumping action of the wheel loading. *Source:* Ed Cantle
- The floor of a steep ramp heading should not be paved with asphalt. The problem is that the asphalt surface will rill with the application of wheel brakes. *Source:* George Greer
- On the initial drive, the rail should be installed beneath its final grade. It is a lot easier to lift and ballast the track to its final surveyed grade than it is to dig out and lower it. *Source:* Marshall Hamilton
- The braking power of a battery-operated locomotive is limited by the weight of the locomotive itself. This restricts the train speed and the number of cars that can be safely hauled. *Source:* Jack Burgess
- When selecting locomotives and cars for underground application, size the loco to the payload in one car. The train will be 10 - 12 cars long. Appropriate adjustment can be made if shorter trains are needed. *Source:* Kirk Rodgers

11.4 Track versus Trackless

A “track” mine refers to one that has rail installed in its lateral headings to provide travel for trains drawn by battery-operated, trolley, or diesel locomotives. A “trackless” or “mechanized mine” refers to the use of rubber tired mobile equipment to advance the lateral development and haul the ore. The basic component of an operation is the LHD unit. Of course, some mines employ a combination of track and trackless headings and many employ conveyors in drifts and declines for ore handling.

The trend for some time has been away from track development. Even the smallest of mines are now considered best served by trackless methods, mainly due to flexibility. At the larger mines, rail haulage has been largely displaced by conveyor transport fed from an underground crusher placed near the orebody so that it can be gravity fed by trackless equipment enjoying a short haul distance.

Trackless headings have other significant considerations besides flexibility. Both the productivity (i.e. feet per man-shift) and rate of advance (i.e. feet per month) are normally significantly higher for trackless headings than for rail headings.

Following are the principal disadvantages of trackless headings.

- The need more ground support because trackless headings are larger in cross section
- The equipment that drives trackless headings requires more ventilation
- The roadway is more difficult to maintain

Employing electric powered LHD units and trolley-line truck haulage reduces ventilation requirements; however, flexibility is impaired.

11.5 Design and Function of Lateral Headings

The design starts with determining the cross-section of the drift, cross cut, ramp, or decline. Lateral headings are contoured to the minimum dimensions required to safely permit passage of the largest vehicle while providing space for roadway dressing (or rail and ballast), ditches, utility lines and ventilation duct. Safe clearance must be provided for pedestrian traffic, especially if no safety bays are to be cut. The minimum clearances and the spacing of safety bays are usually specified in the applicable statutory mine regulations. If the heading is to become a main airway, its cross section may have to be enlarged for this purpose.

In the recent past, the size of typical lateral headings has continued to increase because larger and larger haulage vehicles are employed. The philosophy has been to reduce costs by economy of scale. Larger headings are not advanced as rapidly as smaller headings, which has the effect of slowing the pre-production development schedule for a new mine and ongoing development at an existing operation.

Employing remote operation and guidance systems that enable one operator to run two or three units of equipment simultaneously allow greater productivity improvement than further increasing equipment size. In this regard, a unique system employed at the Savage Zinc mine in Tennessee may have good application elsewhere (the mine employs a trackless "road train" with a 75-ton payload that travels underground at speeds of 25 miles per hour in a relatively small heading at a gradient of 6%). High-speed haulage is also employed at several underground operations in South America using a "throw-away" haul truck. For this purpose, the mines have dispensed with the typical slow-moving articulated underground truck and replaced it with one designed for highway travel. The truck is a stock model modified with a supercharger and oversize inter-cooler. After a useful service life of only two to three years on mine grades of 10%, a truck is sold to the after market for light duty and replaced with a new one. Some of these same mines employ surface-type front-end loaders underground instead of LHD units to muck from draw points and load the haul trucks with apparent great success. The Australians have employed relatively high-speed truck haulage for many years using off-road haulage trucks modified for underground service at typical gradients of 9:1 or 12%. (Refer to Chapter 4 for more information on truck haulage in Australia.)

Track headings are normally fully arched with a vent duct hung at the crown when driven. For trackless headings, it is common practice to hang the vent duct and utility lines on the ditch side to save space and help protect them from wayward vehicles. When a very large vent duct is required, two ducts are used instead. These are hung from the back on either side of the heading, leaving the central portion open to permit passage of the heaped load on a haul truck. The back of these headings may be gently arched or driven flat backed, depending on the ground conditions (mine company standards may dictate an arched back).

11.6 Laser Controls

Historically, both conventional and trackless development headings were driven using standard line and grade plugs as a means of controlling the azimuth and gradient of the heading. As the distance between the control points and the face increases, the quality of control diminishes. This is particularly important in the conventional headings as the grade control line is used for rail installation. Typically, line and grade plugs are useful for about 280 feet (85m) and then new controls must be installed.

Grade plugs are installed in the walls of the heading. Line plugs are installed in the back, and may or may not include a survey control point. Both types of controls are frequently damaged during regular mining practice. The damage may occur due to neglect or by accident. In either case, re-installation of these controls generates additional work for the surveyors; therefore, additional delays for the mining crews. Furthermore, line and grade plugs are prone to inaccuracy, depending on the diligence and skill of the persons who use them.

For straight development headings that exceed 800 feet (240m) in length, the solution to these problems is the use of laser beams. Following are the benefits of using laser survey controls.

- A single installation will remain useful for a much greater distance than with conventional line and grade plugs reducing the overall amount of production shut down due to surveying.
- A single laser installation provides both line and grade control.

- A laser installation provides more accurate basis for each crew to correctly determine the orientation required for each drill hole.
- A laser installation is less likely to be damaged than conventional line and grade plugs.
- A laser installation can be mounted in such a manner that will allow traffic to pass by without disturbing the setup.
- A laser installation is not affected by ventilation.
- Check points can be installed to verify the laser's alignment prior to marking the face.
- Laser lines provide a ready source of control points for starting additional excavation control.

12.0 Collars & Portals

12.1 Introduction

On the surface of an underground mine, a collar is required for a shaft or raise entry, while a portal refers to the entrance for an adit, decline, or ramp.

Collar

Besides providing a mine entrance, a shaft collar for a production shaft performs the following functions.

- Keeps the shaft watertight.
- Provides a top anchor for the shaft sets and the plumb lines required for shaft surveying.
- Provides space for the shaft sinker to install equipment before the main excavation process begins.
- May support a portion of the headframe.

Collars are also required for ventilation shafts, service shafts, and for all raises that reach surface. Constructing collars in a rock outcrop or in shallow overburden is relatively straightforward; however, if the soil overburden is deep and especially if it is water bearing, collar construction can become a major project. The same is true of a portal, but in this case, if the overburden is deep and water bearing, the construction may be more difficult or even impractical.

Shaft and raise collars are normally lined with concrete. The design of a concrete lining for shafts and shaft collars is discussed in Chapter 9, Shaft Sinking.

Portals

Portals may be left open to the elements in tropical zones; however, the entrance is normally enclosed with a weather-tight structure in temperate or arctic climates. This structure was once built with timber or reinforced concrete, but now miners usually employ corrugated metal archways similar to those used for large highway culverts. For a ramp entry in overburden, this structure can become very long. In the case where the portal carries a conveyor, the archway is designed with enough strength to accommodate hangers that suspend the conveyor support frames.

Portals for ramps and declines usually incorporate a reverse slope at the start to prevent surface water from running into the mine.

12.2 Rules of Thumb

Collars

- The elevation of a shaft collar should be 2 feet above finished grade. *Source:* Heinz Schober
 - The typical thickness of a concrete lining for a production shaft collar is 24 inches in overburden and 18 inches in weathered bedrock. For a ventilation shaft collar, it is 18 inches in overburden and 12 inches in weathered bedrock. *Source:* Jack de la Vergne
 - The finished grade around a shaft collar should be sloped away from it at a gradient of 2%. *Source:* Dennis Sundborg
 - A shaft collar in overburden, completed by any means other than ground freezing (which may take longer), will be completed at an overall rate of 1 foot per calendar day. *Source:* Jim Redpath
 - For a shaft collar in deep overburden, the minimum depth of socket into bedrock is 3m (10 feet) in good ground, more if the rock is badly weathered or oxidized. *Source:* Jack de la Vergne
 - The minimum depth for a timber shaft collar is 48 feet (15m). *Source:* Jack de la Vergne
 - The minimum depth for a concrete shaft collar is 92 feet (28m). If a long round jumbo is to be employed for sinking, it is 120 feet. *Source:* Jack de la Vergne
 - For a ground-freezing project, the lateral flow of subsurface ground water in the formation to be frozen should not exceed 1m per day. *Source:* Khakinkov and Sliepcevich
 - To determine the diameter of a proposed circle of freeze pipes around a shaft collar, 60% should be added to the diameter of the proposed excavation. *Source:* Sanger and Sayles
-

Collars (continued)

- When ground freezing is employed for a shaft collar, the area of the proposed collar excavation (plan view) should not be greater than the area to remain inside the circle of pipes (area that is not to be excavated). *Source:* B. Hornemann

- The minimum practical thickness for a freeze wall is 4 feet (1.2m). *Source:* Derek Maishman

- The maximum practical thickness for a freeze wall with a single freeze circle is 16 feet (5m). Concentric circles of freeze pipes should be employed when a thicker freeze wall is required. *Source:* Derek Maishman

- The radiation (heat transfer) capacity of a freeze pipe containing brine may be assumed to be 165-kilocalories/square meter of pipe surface. However, if the brine velocity is too slow (laminar flow), this capacity will be reduced by 40%. *Source:* Jack de la Vergne

- The capacity of the freeze plant selected for a ground freezing project should be 2-2½ times the capacity calculated from the radiation capacity of the total length of freeze pipes installed in the ground. *Source:* Berndt Braun

- Groundwater movements over 3 to 4 feet per day are significant in a ground freezing operation. *Source:* U.S. National Research Council

- If the drill casing is left in the ground after installing the freeze pipes, it will cost more but the freeze pipes will be protected from blast damage or ground movement and the heat transfer will be increased due to the greater surface area of the steel casing. *Source:* Jim Tucker

- The heat gain from circulating brine is equal to the sum of the friction losses in the pipes plus the heat generated due to the mechanical efficiency of the brine pump. The value calculated for the heat gain should not exceed 10% of the refrigeration plant capacity. *Source:* Jack de la Vergne

- The amount of liquid nitrogen (LN) required to freeze overburden at a shaft collar is 1,000 Lbs. of LN/cubic yard of material to be frozen. *Source:* Weng Jiaye

- Due to the heat of hydration, the long-term strength of concrete poured against frozen ground will not be affected if the thickness exceeds 0.45m (18 inches). Below this thickness, designers will sometimes allow a skin of about 70-mm (2¾ inches). *Source:* Derek Maishman

Portals

- The minimum brow for a portal in good ground (sound rock) is normally equal to the width of the decline or ramp entry. It may be reduced in steeply sloped terrain or leaving “shoulders” (instead of a vertical face) and/or by proper ground support with resin grouted rebar bolts. *Various Sources*

 - When slurry walls, freeze walls, or sheet piling are employed for portal entries in deep, saturated overburden, they should be placed to a depth 50% greater than the depth of the excavation to avoid uplift on the bottom. *Source:* Jacobs Engineering

 - The maximum practical depth for sheet piling in cohesive soils approximately 60 feet (18m). In granular soils, it is usually little more than 40 feet (12m). *Source:* Jack de la Vergne

 - Standard well point systems are based on suction (vacuum) lift and the practical limit for lowering the groundwater is normally about 5m (16 feet). It is typical to provide a second stage of well points to lower it further. *Source:* Stang Dewatering Systems

 - Well point systems employing jet eductor pumps are capable of lowering the ground water by 12 to 15m (40 to 50 feet) in one lift. *Source:* Golder Associates
-

12.3 Tricks of the Trade

- Excavating a shaft collar in rock may be expedited by pre-drilling blast and cut holes to the full depth. The drill holes are filled with an inert material a portion of which is blown from the holes for each successive blast cycle. Coarse sand has been used as the agent, but it tends to pack. Better results are obtained by employing pea gravel or the “micro-balloons” used as a bulking agent in explosives. *Source:* Bill Shaver and others
- No deep excavation in overburden should be executed without first obtaining a comprehensive soils report that will include recommendations for excavation methods to be employed. *Source:* Steve Boyd

- Shaft collars in soil overburden should be excavated with a circular cross section even if the shaft is to be rectangular or square. *Source:* Proctor and White
- For the design of the liner shaft collar in deep overburden, it is expedient to assume the ground water table at surface elevation and/or (to account for soil arching) that at least 70% of the maximum theoretical active soil pressure is applied throughout the total height of the collar. *Source:* Karl Terzaghi
- Shaft collars and ramp portals in overburden less than 20 feet (6m) deep are almost always most economically excavated by open cut. If the existing ground water table is beneath the depth of excavation, they may be economically excavated to depths of 50 feet (15m) by open cut; however, it is a rare event that the ground water table at a minesite is found deep. In most circumstances, the water table is near surface and the following guidelines will apply.
 - If the soils are granular (coarse grained sand or gravel) and “clean” (no fines), they can be economically excavated up to 40 feet (12m) deep by open cut. In this case, dewatering can take place from within the excavation and side slopes may be laid out as steep as 1½:1.
 - In typical glacial till with minimal water flow, they may also be economically excavated up to 40 feet (12m) deep by open cut. In this case, it is normally required that the water table be lowered with the use of well points (in stages, if necessary) on the perimeter of the excavation to minimize the flow of water into the excavation. In this case, the side slopes of the excavation can usually be laid out at approximately 2:1.

Various Sources

- When well points or deep wells are employed for dewatering it is important to provide a standby generator and spare pumps at the job site. *Source:* Joe Evans
- Well point headers should not be placed at the surface of the excavation. They will be more effective if they are placed just above the existing water table because this will reduce the suction lift to a minimum. *Source:* Edward Johnson
- If the soils to be excavated contain distinct horizontal layers of coarse sand or gravel (with relatively high permeability), deep wells with ITH pumps are very effective and should be considered as an alternative to well points. *Source:* Harry Cedergen
- Shaft collars in granular soils may normally be dewatered as deep as 65 feet (20m) with the use of deep wells. Deeper collars are normally frozen to keep the excavation watertight and support the walls of the excavation until the permanent lining is placed. *Source:* Jack de la Vergne
- Dewatering is not normally a practical method for fine-grained soils such as clays and silts, unless they occur in thin horizontal beds within a granular matrix. Either ground freezing or big-hole drilling is normally an economical and practical choice for this circumstance. *Source:* Terry McCusker
- The ground water in silt, silty sand, or very fine-grained sand that does not respond to normal gravity draw down, may be lowered using electro-osmosis. This method employs an existing line of metal well points as cathodes and a line of steel rods placed on the excavation side of the well points used as anodes. When an electrical current is introduced, water flows toward the cathodes where it is pumped to surface. *Source:* Leo Casagrande
- Sinking caissons are rarely employed today for shaft collars because they are no longer considered economical or practical when compared with other methods. In the past, significant problems have occurred with this method, the main one being obtaining a seal at the bedrock elevation. *Source:* Jim Redpath
- Shaft collars in deep overburden should be advanced with an excavation radius at least 5 feet larger than the proposed excavation radius of the shaft. This is to account for overbreak at the rock entry and to permit an integral concrete bearing ring to be poured at the interface instead of down deeper into bedrock. *Source:* Steve Boyd and others
- Shaft collars in deep overburden can be excavated at less expense if the excavation is first advanced by open cut down to the elevation of the water table (to a maximum of 40 feet of depth) by open cut. It is important to provide a level working area and space for a collection ditch and sump of at least 10 feet (3m) around the perimeter of the planned excavation at the bottom of the cut. The open cut should include an access roadway to the bottom of the excavation at a gradient of approximately 10%. *Source:* Redpath and Dengler
- Most shaft collars in deep overburden are most economically excavated by using liner plate segments to support the walls. If the excavation is of large diameter, the liner plates are reinforced with ring beams. *Source:* Joe Evans
- If provided with a soils report and the required dimensions, suppliers of liner plates and ring beams will often provide useful advice and perform the necessary engineering calculations to ensure a safe design (at no cost) in support of their quotation to supply the materials. *Source:* George Martin
- Liner plate collars can be prevented from shifting off vertical during excavation by drilling and installing a pipe casing at the four quadrants of the excavation circle. *Source:* George Martin

- When the stand-up time is too short to install the next ring in a liner plate collar, the excavation may proceed under cover of spiling. If the spiles to be driven are made by tapering the end of pipe or square structural tubing (HSS), they may be later used for nitrogen freezing, if you get into real trouble. *Source:* George Martin
- When using sheet piling to excavate a shaft collar in overburden, it is advantageous to build a scaffold inside the ring to guide the piles. *Source:* Jim Redpath
- When using sheet piling to excavate a shaft collar beneath the water table, it is advisable to chemical grout around the outside perimeter of the piling, especially at the soil/rock interface. *Source:* Burt Eastman
- Soldier piles (H-beams) and lagging are rarely employed for shaft collars in deep overburden, mainly because this method is not considered suitable for working beneath the water table in close confinement. It is virtually impossible to lower the water table right to bedrock horizon due to the draw-down cone between well screens or points. For portal entries in saturated overburden, they may be employed (with cross bracing or tiebacks) when there is no room for an open cut excavation. In this case, they typically require well points to lower the ground water to well beneath the depth of the excavation. *Source:* Jack de la Vergne
- Slurry walls are rarely employed for shaft collars in deep overburden, mainly because this method is too expensive. The high cost is partly due to the fact that a second concrete lining is normally found to be required inside the slurry wall. For portal entries in saturated overburden, slurry walls may be employed (with cross bracing or tiebacks) when there is no room for an open cut excavation. They have an advantage over soldier piles and lagging for this procedure because they are supposed to be watertight. Most contractors will construct a water-tight slurry wall in cohesive soils. In glacial till or other soils containing cobbles and boulders, the contractor (that submitted the low bid) for a slurry wall is often not successful in providing a 100% watertight diaphragm. In one extreme case, there were holes later found in a slurry wall large enough to drive a truck through. *Source:* Moretrench American Corporation
- Big-hole drilling is not normally employed for shaft collars in deep overburden due to the expense of mobilization and the high cost of the lining; however, they are competitive for small shaft collars (finished inside diameter 4m, or less) in very deep overburden (over 50m) that is water bearing. *Source:* Louis Donolo
- Using blankets of filter cloth or selected granular (filter) material on portal excavation side slopes where seepage is emerging will often aid in holding the soil in place and prevent sloughing. *Source:* Harry Cedergen
- When necessary, the bottom slopes of an open cut portal excavation may be kept stable even when they penetrate the water table by employing a rip-rap support constructed of boulders or oversize shot rock. *Source:* John Seychuck
- When necessary, the bottom slopes of an open cut portal excavation may be kept stable when they penetrate the water table by installing horizontal drains consisting of 1½-inch diameter PVC plastic pipes machined with fine slots that are as narrow as 0.010-inch (¼mm). *Source:* U.S. Patent No. 3,391,543
- Ground freezing with liquid nitrogen should only be considered for temporary or emergency conditions (1-2 weeks). For the longer term, conventional freezing with brine is less expensive. *Source:* George Martin
- The freezing method may be simply applied to a small problem by laying bags of solid carbon dioxide (“dry ice”) against the problem area and covering it with insulation. In this manner, ground may be frozen to a depth of up to 1.5m (5 feet). *Source:* C.L. Ritter
- When making the calculations required for ground freezing, it is necessary to have a value for the natural temperature of the ground. If this temperature is not available, the average or mean annual surface temperature at the project may be used for this value without sacrificing accuracy. *Source:* Jack de la Vergne
- The brine circuit employed for a ground-freezing operation requires a surge chamber. The best one consists of an elevated tank (open to the atmosphere) in a short tower. It provides simple visual observance of the pumping head and, if equipped with a sight gage, gives precise changes in the volume of brine in the system and early notice if a leak should occur. Slight losses in brine volume will occur as it becomes colder (coefficient of volumetric thermal expansion is 0.00280 per degree Fahrenheit). *Source:* Leo Rutten
- When freezing a shaft collar with a conventional brine system, you can tell when the freeze wall cylinder has built up to the point of closure by noting a sudden rise of the water level in the pressure relief hole drilled in the center. Excavation may normally commence soon afterwards, since the ground pressure against the freeze wall is smallest near surface. *Source:* Derek Maishman
- When freezing a shaft collar with a conventional brine system, the freeze pipe headers must be bled of any air accumulation, once a day. *Source:* Leo Rutten
- When freezing a shaft collar with a conventional brine system, thermometer instruments should be re-calibrated once a week by inserting a thermocouple into a container filled with water and ice (temperature exactly equal to the freeze point of water). *Source:* John Shuster
- If the freeze wall does not close when calculated, the problem may be due to a flow of ground water. If the return temperature of the brine from holes on opposite sides of the freeze circle is slightly higher than the average, there is very

likely a significant lateral flow of ground water. The elevation of this flow in the ground strata may be determined by stopping the brine flow to one or more of the "problem" freeze holes, waiting two hours and then measuring the standing brine temperature at vertical intervals (usually 2 feet). The water is flowing where the brine temperature is slightly higher than the rest of the measurements. If the return temperature of the brine from only one hole is higher than average, it can mean that ground water is flowing from the bedrock where it is penetrated by the freeze pipe. In either case, the default remedy is to grout from holes drilled to the vicinity of the problem area(s). If the return temperature from one hole is lower than average, it usually means there is a short circuit in that hole. (The inner freeze pipe, usually plastic, was not installed to the bottom of the hole, or it has come apart at a splice.) The proof is to pull the inner freeze pipe from the hole so it can be measured and examined. *Source:* Jack de la Vergne

- When a liability rider is incorporated in the contract documents for a ground-freezing project, the contractor will often extend the ground freezing cycle. For a shaft collar, this often means that the excavation will be frozen solid inside the freeze circle before releasing it for excavation. While this procedure provides added safety, it increases the costs and delays the project because excavation is much more difficult in frozen ground than it is in a soft core. *Source:* Derek Maishman
- An acoustic instrument has been developed to measure the thickness of a freeze wall under construction. (The speed of sound is different in frozen and unfrozen ground.) This instrument is not reliable (and its use may lead to great confusion) unless it is employed by a single experienced operator and is properly calibrated before the freezing process begins on a particular project. *Source:* Jack de la Vergne
- If a brine freeze plant does not cool to the expected final temperature [at least -25°C (-13°F)], the most likely causes in order of greatest frequency are as follows.

Cause	Remedy
– Low level of refrigerant	Top up
– Clogged water spray holes	Remove and clean piping over condenser
– Oil build-up in refrigerant	Bleed off at bottom
– Air in refrigerant	Bleed off at top
– Vacuum feed to compressor	Adjust to positive feed
– Faulty valves in brine line	Replace
– Faulty expansion valve	Replace
– Undersize brine mains	Replace
– Oversize brine pump	Replace

Source: Jack de la Vergne

- If the freeze wall ruptures during excavation of a shaft collar, it will occur near the bottom of the excavation. Normal practice is to immediately clear personnel and equipment from the bottom and dump a truck load(s) of fine gravel or coarse sand in the excavation to prevent further inflow of soil through the freeze wall. It is then typical practice to drill from surface and chemical grout in the vicinity of the breach. Then, drill and install another freeze hole in the vicinity of the breach to accelerate and reinforce its closure, after which the excavation may resume. The new freeze hole may be frozen with liquid nitrogen to minimize the delay. *Source:* Leo Rutten
- If a freeze wall rupture occurs in a section of the excavation that is in very compact granular soil, undisturbed glacial till, or in the bedrock, normally only water will flow into the excavation. In this case, it is typical procedure to allow the excavation to flood. When the level of the water in the shaft collar has peaked, ready-mix concrete is tremied or pumped down through the water to form a concrete pad on the bottom. Once the concrete has set and sufficiently cured, the shaft collar is pumped dry and grout is injected through the pad. When the grouting is completed and the freeze wall restored, the pad is broken up and the excavation can safely resume. *Source:* Jack de la Vergne

12.4 Well Points and Well Pump Dewatering

The primary function of a well points or deep well is to lower the level of the ground water within the working area of a proposed excavation in soil (overburden). The ground water is lowered by collecting and pumping it to surface in wells adjacent to the excavation perimeter. The procedure is generally referred to as "dewatering." The procedure works very well in coarse-grained sands. It can be much less efficient with fine-grained sands and is usually not practical for cohesive soils (silts and clays) unless they occur in horizontal layers underlain by permeable coarse-grained soils.

Some dewatering contractors may engage in "creative engineering" to sell a contract for dewatering a particular project, when in fact, the procedure is not practical for the application.

When it is effective, dewatering benefits the excavation procedure in a number of ways.

- It greatly reduces or eliminates the requirement to pump ground water from within the advancing excavation.
- It prevents the bottom of the excavation from becoming “quick” or heaving.
- In open cut excavation, it raises the angle to which the side slopes can be safely cut without danger of sloughing or slope failures significantly reducing the amount of material to be excavated.
- In vertical excavations, it removes the hydrostatic pressure against temporary ground supports or sheet piles.
- In vertical collar excavations (that are sunk), it normally provides sufficient stand-up time on the exposed walls for temporary supports to be installed.

Well point systems are usually defined as groups of closely spaced wells connected to a header pipe (manifold) and pumped by suction lift. The riser casing in the well usually consists of a 1½ -inch diameter steel pipe. A screen section is incorporated at the bottom of the casing (usually 2-inch diameter) referred to as the “point.” The point is specially designed for water jetting the well casing in place (without drilling). The jetting consists of forcing water under pressure down through the riser pipe and out through orifices in the tip of the point. After a well point has been advanced to the full depth, a ball valve automatically provides a seal at the orifices and restricts the flow of ground water to the slotted section.

Once the well points are in place they are connected on surface to a manifold line leading to a centrifugal pump(s). An air separation chamber ensures that the pump is kept full of water at all times. In some soil conditions, point jetting does not work and in this case either a separate jet pipe is first employed or the wells are drilled. Once the excavation and construction work is completed, the well casings (and points) are extracted for re-use on the next project.

Deep wells are the same as ordinary drilled water wells that incorporate conventional ITH pumps. While there are few contractors experienced with well points, there are hundreds of well drilling contractors well experienced in drilling and installing deep wells. It is usually the case that a local drilling firm is employed for providing deep wells because his experience in drilling similar terrain in the area of the project can be of great value. Unfortunately, a typical well drilling contractor is normally concerned only with the yield of a drilled well and not with its capacity for dewatering a proposed excavation. He may have to be “educated” in advance about the special requirements for successful deep wells on a dewatering project.

12.5 Big Hole Drilling

A large number of big-hole drilling contractors are equipped and experienced for drilling in overburden on civil projects. These firms may believe and propose that a shaft collar need only to be drilled to the rock horizon. When such a proposal is executed, it often leads to difficulties because the rock horizon is where acute problems are most likely to occur. These include obtaining an adequate seal at the soil/bedrock interface and unavoidable overbreak when sinking into the rock from the bottom of the drilled shaft.

To drill a shaft collar successfully, a contractor should be selected whose rig and procedure is readily capable of drilling and lining the excavation at least 5m (16 feet) into the bedrock. The contractor’s procedure should ensure that the installation of the permanent lining (casing) extends to the bottom of the hole in the bedrock and includes provision a good seal between it and the walls of the socket into the bedrock.

While these precautions help to reduce risk, this procedure remains extremely expensive for a deep collar. The reason for the added expense is that the standard procedure does not permit stiffening rings on the steel casing. The casing is usually a watertight (hydrostatic) lining¹ and, therefore, must be made very thick to avoid buckling. The cost of such a casing can easily exceed \$500,000. In certain cases, an inexpensive “leaky liner” may be installed that eliminates the hydrostatic head.

¹ Refer to Chapter 9 for definition and design of the steel hydrostatic liner and “leaky liner.”

12.6 Ground Freezing

Ground freezing is considered the most reliable means to support a collar excavation in deep overburden. The method may be used for ramp entries; however, ground freezing is unusual for deep entries due to the large number of pipes required and because of the difficulty in arranging the piping to obtain a freeze in the overburden above and beneath the proposed excavation.

Ground Freezing Procedure

Shaft collars have been sunk employing ground freezing for over a century and so today the procedure is well understood and straightforward. Normal practice is to engage a contractor that specializes in ground freezing. A number of vertical freeze holes will be drilled around the perimeter of the proposed excavation to form the "freeze circle." The spacing between the freeze holes varies from 2½ feet (0.8m) for shallow excavations with small freeze pipes and to 6½ feet (2m) for very deep excavations with larger freeze pipes. Each freeze column extends into the bedrock. Two pipes are installed in each freeze hole, one inside the other. The larger pipe is sealed at the bottom so that chilled brine directed in a continuous flow down the inner pipe will return to surface in the annular space between the pipes. Having taken up heat in the ground, it is then re-cooled in a refrigeration plant. Traditionally, the brine velocity in the annular space was designed high enough to obtain turbulent flow and assure good heat transfer. More recently, it has been determined that the transfer will not be affected if the velocity is lowered into the "mixed-flow" region; however, it should not be so slow that the flow is laminar. The brine selected is almost always calcium chloride (road salt), which in theory is capable of lowering the freeze point of the brine to a minimum of -51°C (-60°F) at a concentration of 29.6 % calcium chloride (SG =1.290).

Ground Freezing for a Frozen Shaft Collar

Following is a procedure and an example for designing the ground freezing for a frozen shaft collar.

To design the required thickness of the freeze wall, it is first necessary to determine the strength of the soil once it is frozen. Normally, the soil is saturated. In the rare case that a portion of the freezing is in dry soil, it is wetted when the freezing takes place. The strength of wet soil when it is frozen depends on the temperature (the colder, the harder) and the type of soil to be frozen (frozen sand is stronger than frozen clay).

The actual temperature of the freeze wall varies from the temperature of the brine near the freeze pipes to the freezing point of water (which is zero on the Celsius scale and 32 degrees on the Fahrenheit scale) at the perimeters. To simplify the calculations, one temperature is assumed for the whole cross-section of the freeze wall. For normal brine freezing, this temperature is +14°F (-10°C). At this temperature, the strengths may be assumed for the freeze wall from Table 12-1.

Table 12-1 Approximate Unconfined Compressive Strengths of Frozen Ground

(Interpreted from the results of tests taken at various laboratories)

Temperature (degrees Fahrenheit)	26		20		14		8	
Temperature (degrees Celsius)	-3.3		-6.7		-10.0		-13.3	
	psi	MPa	psi	MPa	psi	MPa	psi	MPa
Sand	1,200	8.3	1,500	10.3	1,800	12.4	2,000	13.8
Clayey Sand	700	4.8	1,000	6.9	1,150	7.9	1,250	8.6
Sandy Clay	450	3.1	600	4.1	750	5.2	900	6.2
Clay	350	2.4	550	3.8	700	4.8	-	-
Silty Sand	-	-	-	-	1,000	6.9	1,200	8.3
Silty Clay	-	-	-	-	600	4.1	900	6.2
Silt	270	1.9	400	2.8	500	3.4	-	-
Ice	300	2.1	500	3.4	650	4.5	850	5.9

The ground pressure against the freeze wall to be designed is best obtained from the soils report, or a soil mechanics specialist. For relatively shallow collar excavations, a minimum practical thickness of freeze wall (roughly equal to the distance between the freeze pipes) is usually thicker than required for strength. For preliminary calculations on deeper excavations, the ground pressure beneath the water table may be assumed as follows.

- Cohesive soils (clays and silts) 2.0 times the hydrostatic pressure
- Granular soils (sands and gravel) 1.5 times the hydrostatic pressure
- Bedrock 1.0 times the hydrostatic pressure

Note

The hydrostatic pressure is the pressure at the bottom of a column of water at the depth considered. It is equal to 0.4335 psi multiplied by the depth in feet (9.807 kPa multiplied by the depth in meters).

With the strength of the freeze wall and the ground pressure against it determined, the required thickness of the freeze wall is most often calculated by the Domkë formula, which contains an appropriate factor of safety and provides the dimension (S) equal to half the total thickness required.

$$S/R = 0.95 P/K + 7.54 (P/K)^2 \dots \text{Domk\"e (metric or imperial units)}$$

- In which
- R = Radius of the collar excavation (select any unit of length)
 - S = Freeze wall thickness inside the ring (same unit of measure as R)
 - P = the ground pressure (select any unit of pressure)
 - K = compressive strength of frozen ground (same unit of pressure as P)

Example

Find the required freeze wall thickness (t).

- Facts:
1. R = 3.75m (includes an allowance for overbreak)
 2. P = 1.38 MPa (Maximum Ground Pressure)
 3. K = 6.9 MPa (Silty Sand)

- Solution:
1. $P/K = 1.38/6.9 = 0.20$
 2. $S = 3.75[(0.95 \times 0.2) + (7.54 \times 0.2 \times 0.2)]$
 3. $S = 3.75[0.19 + 0.30] = 1.84\text{m (6 feet)}$
 4. Freeze wall thickness, $t = 2S = 3.68\text{m (12 feet)}$

A concrete lining is designed to be poured in place against the frozen ground as the excavation proceeds (or in some cases, afterwards). The lateral design pressure against the concrete lining is the same as was determined for the freeze wall. The thickness of this concrete lining is determined by the method detailed for shaft linings in Chapter 9 Shaft Design. In most cases, the calculated result will be less than the standard minimum thickness of 18 inches (450mm), so this dimension may be assumed correct unless the shaft collar is extremely deep.

The size of the freeze wall circle is then calculated by determining its radius, which is the sum of the excavation radius (R = 3.75m) plus the thickness (S = 1.84m), calculated for the thickness of the freeze wall inside the ring plus a small allowance for contingency. In this case, these dimensions will add up to 5.6m. Therefore, the diameter of the freeze circle is calculated at 11.2m. This diameter can be enlarged to provide the contingency. In this case, the diameter, D, of the freeze circle may be determined at D = 12m (40 feet).

With all of the dimensions of the required freeze wall determined; the distance between the freeze holes and the size of the freeze plant required may be calculated. Since these values are interdependent, it is convenient to tabulate a series of results from different pipe spacings. The tabulation will include the time required to freeze the wall for each case. With these results, the most economical spacing may be estimated.

To complete these calculations, the diameter of the outer freeze pipe must first be determined. For shallow excavations, it can be assumed that a 3-inch diameter pipe will be used because it is the largest diameter that will fit inside a standard 5-inch diameter drill casing. (By convention, the casing dimension often refers to the outside diameter while the pipe dimension always refers to the inside diameter.) For deeper shaft collar excavations, it may be assumed that the outside freeze pipe will be 5 to 6 inches in diameter. For the purposes of the following calculations, it is assumed to be 5.5 inches in diameter, since this is the outside diameter of a standard sized well pipe commonly used as the freeze pipe for deeper shaft collar projects. For very deep ground freezing projects where the shaft as well as the collar is to be frozen, great attention is paid to the specifications for the selection of the freeze pipe and its couplings. The reason for this is mainly due to the fact that the coefficient of thermal contraction of the pipe is less than the ground to which it adheres. For this purpose, D.I.N. (German) and American Petroleum Institute (API) specifications are relied upon. In one case where freeze pipes ruptured, it was necessary to replace the calcium chloride with lithium chloride (freeze point of -83°F) to freeze the contaminated ground.

The most difficult part of the calculations can be determining the heat transfer from the ground to the cold brine through the freeze pipe wall. It is convenient (and common practice for shaft collars) to simply use a rule of thumb for this figure. Another rule of thumb provides the capacity of the refrigeration plant required. The time required to complete the freeze wall is calculated by the following formula.

$$T = (V\gamma/q) \left[\frac{1}{\pi d L N} \right] W (80 + t_2 - 0.5t_1) \dots \text{Fritz Mohr (metric units)}$$

- In which
- T = Time to complete freeze wall hours
 - V = volume of ground to be frozen (dm)³
 - γ = Dry bulk density of soil kg/(dm)³
 - q = radiation capacity of freeze pipes k cal/m³
 - Cg = Specific heat of soil material dimensionless
 - d = outside diameter of freeze pipe m
 - L = length of each freeze pipe m
 - N = number of freeze holes dimensionless

To facilitate calculations, they can be simplified by substituting known values and given criteria. Following are the known values (constants).

- Latent heat of freezing water = 80 cal/ gm = 144 BTU /Lb. (1 k cal = 3.968 BTU)
- Specific heat of water = 1.00 Specific heat of ice = 0.50
- Specific heat of soil = 0.23 Specific heat of rock = 0.23

Example

Calculate the time required to freeze the ice wall and refrigeration plant capacity required for several likely hole spaces (4, 5 and 6 feet). The calculations will be based on the previously described collar excavation, with the following additional facts.

- Facts:
1. The depth of overburden is 240 feet
 2. The holes are drilled 22 feet into bedrock (freeze pipe length, h= 262 feet or 80m)
 3. The natural temperature of the ground is 41°F (5°C)
 4. Water content, w = 20%
 5. Bulk dry density, γ = 106 Lbs./cubic foot (1.7 kg/dm³)

- Solution:
1. The Mohr formula may then be employed – the volume of the completed ice wall, V as designed is first calculated:
 - a. Outside radius of freeze wall cylinder, R_o = 6 + 1.84 = 7.84m
 - b. Inside radius of freeze wall cylinder, R_i = 6 - 1.84 = 4.16m
 2. $V = \pi h(R_o^2 - R_i^2) = 80\pi (7.84^2 - 4.16^2) = 11,100m^3 = 11,100,000 \text{ dm}^3$
 3. $T \times N = (11,100,000 \times 1.7/165\pi \times 80 \times 0.14) \times [0.23(5 + 10) + 0.20 (80 + 5 + 10/2)]$
 4. $T \times N = 3,250 [3.45 + 18] = 69,720 \text{ hours} = 415 \text{ weeks}$

Table 12-2 Freeze Pipe Spacing (1)

Freeze Pipe Spacing, z	4 feet	5 feet	6 feet
Normal Freeze holes, N = πD/z = 40π/z	31	25	21
Time to complete freeze wall = 415/N	13 weeks	17 weeks	20 weeks
Extra freeze holes to close gaps (assumed)	3	3	3
Total length freeze pipes = (N+3)L = (N+3)80	2,720m	2,240m	1,920m
Surface area of freeze pipes/m = πD = 0.14π	0.440 m ² /m	0.440 m ² /m	0.440 m ² /m
Radiation capacity of freeze pipes @165 k cal/hr	197,470	162,620	139,400
Radiation capacity (1 k cal = 3.968 BTU)	789,888	645,290	553,110
Radiation capacity (1 ton = 12,000 Btu/hr)	65.8	53.8	46.1
Refrigeration Plant capacity @ 2.5 x radiation	165 tons	134 tons	115 tons

This tabulation provides the freeze plant capacity and the time taken to complete the total freeze wall; however, excavation may begin shortly after the freeze wall is closed. The overall schedule for a ground-freezing project (and hence the cost) is more dependent on the freezing time elapsed until the excavation may start than it is for completing the full thickness of the freeze wall. The time of ground freezing required until excavation can begin is provided by the following formula.

$$T = R^2/4KV_S \{ (L + C_1V_0 + 3C_2V_0) (2 \ln R^{-1}) + C_1V_S \}$$
 Sanger (imperial units)

In which	T= Time to complete freeze wall	hours
	R= ½ the maximum actual pipe spacing	(z+2)/2 feet (1 foot deviation)
	K = conductivity of frozen ground	1.4 BTU/hr/ft ² /°F/foot
	V _s =degrees below freezing (brine)	32 - (-4) = 36° F
	V ₀ =degrees above freezing (soil)	41 – 32 = 9° F
	L = Latent heat of fusion of water in soil	144 x 0.2 x 106 = 3,053 BTU/ft ³
	C ₁ = Thermal capacity of frozen soil	0.5 x 0.2 x 106 +0.23 x106 = 35 BTU/ft ³ /° F
	C ₂ = Thermal capacity of thawed soil	1.0 x 0.2 x 106 +0.23 x106 =56 BTU/ft ³ /° F
	R' = R/radius of freeze pipe	12 x2R/5.50 =4.36R

Table 12-3 Freeze Pipe Spacing (2)

Freeze Pipe Spacing, z	4 feet	5 feet	6 feet
R = (z+2)/2 - assuming 1 foot deviation of holes	3 feet	3.5 feet	4 feet
$R^2/4KV_S = R^2/(4 \times 1.4 \times 36) = R^2/201.6 =$	0.0446	0.0607	0.0794
$(L+C_1V_0+3C_2V_0) = 3,053+(35 \times 9) + (3 \times 56 \times 9) =$	4,480	4,480	4,480
$(2 \ln R^{-1}) = 2 \ln(4.6R) - 1$	4.14	4.45	4.72
$C_1V_S = 35 \times 36$	1,260	1,260	1,260
$(L + C_1V_0 + 3C_2V_0) (2 \ln R^{-1}) + C_1V_S$	19,800	21,200	22,400
T = time until excavation can start (hours)	883	1,287	1,800
Time until excavation can start (Sanger formula)	5.3 weeks	7.7 weeks	10.6 weeks

Selecting a suitable brine pump completes the design exercise. Normally, a single stage centrifugal pump is employed; however, a sliding vane pump is better suited to the application. The ideal design has the flow of brine in the annulus just into the turbulent range while the flow of brine in the inner pipe is laminar. In practice, it is only necessary (and provides for lower heat loss due to friction) if the annular flow is just in the mixed flow range. Usually, it is not practical to provide an inner pipe of the diameter required to obtain laminar flow. The characteristics of the pump required are determined as it is for pumping water, considering Reynold's Number; however, an adjustment is made to account for the different viscosity of brine that varies with the temperature, as follows (for the optimum concentration of 29.6 %).

Table 12-4 Viscosity Compared to Temperature

Viscosity (centipoise)	Fahrenheit	Celsius
19.5	-20°F	-29°C
16.0	-10°F	-23°C
12.8	0°F	-18°C
9.8	10°F	-12°C

The maximum head loss calculated of the pump selected for the application above should be roughly 13 feet (4m). The heat loss can be converted to tons of refrigeration (TR) as shown in the following formula.

$$Q = F \cdot H_f \dots \dots \dots (\text{Cooper})$$

In which	Q = Heat loss (foot-Lb./second)
	F = brine flow (Lb./second)
	H _f = head loss (feet)

Q is then converted to tons of refrigeration (TR) with the appropriate conversion factors:

- 1 BTU = 778.2 foot-Lbs.
- 1 TR = 12,000 BTU/hour

Q is then increased to account for the mechanical efficiency of the brine pump. The value thus obtained should normally be less than 10% of the capacity of the refrigeration plant selected.

13.0 Drum Hoists

13.1 Introduction

Drum hoists are employed in mines on tuggers, slushers, stage winches, cranes, rope tensioners, and even for long plumb line winches. Chapter 13 is mainly devoted to drum hoists that serve as mine hoists (winders). These machines are the most significant hoists in a mine, used for hoisting the ore and waste rock as well as moving personnel, equipment, and materials into and out of the mine.

The drum hoist is the most common type of mine hoist employed in North America, South Africa, and South America. In Europe, Asia, and Australia the friction hoist is predominant (Chapter 14 deals with friction hoists).

Single-drum mine hoists are satisfactory for limited application; however, most are manufactured double drum to facilitate balanced hoisting of two conveyances in the shaft. Balanced hoisting can be accomplished with a single-drum hoist for shallow applications that require a single layer of rope on the drum. In this case, the rope being wound is wrapped in the same grooves that are vacated by the other rope being unwound. Single-drum hoists used to be built with a divider flange and even with the drums of different diameter on either side of the flange ("split-differential") to accomplish balanced hoisting – these designs are no longer manufactured. Recently, large single-drum hoists were installed so that power regenerated in the hoist cycle may be recovered. This chapter is largely devoted to the double-drum mine hoist because it remains by far the most common type of drum hoist employed today.

All mine hoists manufactured today are driven electrically by motors that have an independent ventilation source. Having an independent source reduces the horsepower requirements by more efficient cooling of the windings especially during slow-speed operations and permits filtering of the air that reaches the motor.

Until recently, DC drives with solid-state converters (thyristors) were almost exclusively employed. Lately, larger mine hoists are manufactured with AC drives that are frequency controlled (cyclo-converter).

Typically, the larger double-drum hoists are direct driven with overhung armatures, while double helical gears drive those of medium size. Gearboxes, once employed only on smaller hoists are now found on hoist drives up to 2,000 HP.

For mine applications, drum hoists compete with friction hoists (refer to Chapter 14). The decision concerning which one is best employed for a particular application is discussed as an example of a side study in Chapter 6 – Feasibility Studies. Some hoisting parameters explained in this chapter (e.g. hoist cycle time) have equal application to friction hoists.

For historical reasons, drum hoists (unlike friction hoists) are still thought of in terms of imperial rather than metric units. To describe the size of a drum hoist, miners will say "a 10-foot hoist" rather than "a 3m hoist." For this reason, the explanations and calculations that follow are mainly performed in imperial units.

The Blair multi-rope (BMR) hoist (a variation of the double-drum hoist) employed for extremely deep shafts is not discussed in this chapter.

13.2 Rules of Thumb

Hoist Speed

- The maximum desirable speed for a double-drum hoist with fixed steel guides in the shaft is 18m/s (3,600 fpm).
Source: Peter Collins
- The maximum desirable speed for a drum hoist with wood guides in the shaft is 12m/s (2,400 fpm). *Source: Don Purdie*
- An analysis of the theory developed by ASEA (now ABB) leads to the conclusion that the optimum speed is a direct function of the square root of the hoisting distance. Applying the guideline of 50% and assuming reasonable values for acceleration and retardation leads to the following rule of thumb equation for the optimum economic speed for drum hoists, in which H is the hoisting distance.

Optimum Speed (fpm) = $44H^{1/2}$, where H is in feet

Or, Optimum Speed (m/s) = $0.405 H^{1/2}$, where H is in metres

Source: Larry Cooper

Hoist Speed (continued)

- Assuming reasonable values for acceleration gives the following rule of thumb equations for the design speed of drum hoists, in which H is the hoisting distance (feet).

Design Speed (fpm) = $34 H^{1/2}$, hoisting distance less than 1,500 feet

Design Speed (fpm) = $47 H^{1/2}$, hoisting distance more than 1,500 feet

Source: Ingersoll-Rand

- The hoist wheel rotation at full speed should not exceed 75 revolutions per minute (RPM) for a geared drive, nor 100-RPM for a direct drive. *Source: Ingersoll-Rand*
 - For a direct drive with a DC motor, 100-RPM is an optimum speed rather than a maximum speed. *Source: Sigurd Grimestad*
 - For a skip hoist, the acceleration to full speed should not exceed 1.0m/s^2 (3.3fps^2). For a hoist transporting persons, it should not exceed 0.8m/s^2 (2.5fps^2) as a matter of comfort to the passengers. *Source: Sigurd Grimestad*
-

Hoist Availability

- With proper maintenance planning, a drum hoist should be available 19 hours per day for a surface installation, 18 for an internal shaft (winze). *Source: Alex Cameron*
 - A drum hoist is available for production for 120 hours per week. This assumes the hoist is manned 24 hours per day, 7 days per week, and that muck is available for hoisting. *Source: Jack Morris*
-

Hoist Availability (continued)

- The total operating time scheduled during planning stages should not exceed 70% of the total operating time available, that is 16.8 hours per day of twenty-four hours. *Source: Tom Harvey*
 - In certain exceptionally well organized shafts, utilization factors as high as 92% have been reported, but a more reasonable figure of 70% should be adopted. With multi-purpose (skipping and caging) hoists, the availability will be much lower. *Source: Fred Edwards*
-

Rope Pull

- The manufacturer's certified rope pull rating for a drum hoist assumes the rope flight angle is 25 degrees or more from the horizontal. The rope pull rating should be reduced by 10% for an installation where the ropes run horizontally between the hoist and the head sheave. *Source: Ingersoll-Rand*
-

Hoist Drums

- The hoist drum should be designed to coil rope for the hoisting distance plus an allowance equal in length to 10 dead wraps on the drum. *Source: John Stephenson*
 - The hoist drum should be designed to coil sufficient rope for the hoisting distance plus an allowance of 500 feet, for most applications. Very deep shafts may need 600 feet of allowance. *Source: Jack de la Vergne*
 - The hoist drum should be designed to coil sufficient rope for the hoisting distance plus the statutory three dead wraps, the allowance for rope cuts and drum pull-ins for the life of the ropes plus at least 200 feet of spare rope. (At least 250 feet of spare rope is desirable for deep shafts.) *Source: Largo Albert*
 - The depth of rope groove on the drum should be between 0.30 and 0.31 times the rope diameter. *Source: South African Bureau of Standards (SABS 0294)*
 - The pitch distance between rope grooves on the drum face (of older European hoists) is the rope diameter plus one-sixteenth of an inch for ropes up to $2\frac{1}{2}$ inches diameter. *Source: Henry Broughton*
 - The pitch distance between rope grooves on the drum face on the hoists that we manufactured is the rope diameter plus one-sixteenth of an inch for ropes up to $1\frac{3}{4}$ inches diameter, then it increases to one-eighth of an inch. *Source: Ingersoll Rand*
 - The pitch distance between rope grooves on the drum face of older hoists may be taken at the rope diameter plus 4% for ropes of any diameter, when calculating rope drum capacity of the drum. *Source: Larry Cooper*
-

Hoist Drums (continued)

- Newly manufactured drum hoists (and replacement drum shells) invariably employ half-pitch crossover parallel grooving for which the pitch distance should exceed the rope diameter by 7%. *Source:* Largo Albert
- The pitch distance on drum winders (hoists) should be between 5.5% and 7% larger than the nominal rope diameter. *Source:* South African Bureau of Standards (SABS 0294)
- The maximum allowable hoop stress for drum shells is 25,000 psi; the maximum allowable bending stress for drum shells is 15,000 psi. *Source:* Julius Butty
- The flanges on hoist drums must project either twice the rope diameter or 2 inches (whichever is greater) beyond the last layer of rope. *Source:* Construction Safety Association of Ontario
- The flanges on hoist drums should project at least 2½ rope diameters beyond the last layer of rope. *Source:* South African Bureau of Standards (SABS 0294)
- The flanges on hoist drums must project a minimum of 30mm beyond the last layer of rope. *Source:* Swedish Code of Mining Practice

Shafts and Gearing

- At installation, the allowable out-of-level tolerance for the main shaft of a drum hoist is one thousandth of an inch per foot of length. *Source:* Gary Wilmott
- Square keys are recommended for shafts up to 165mm (6½ inches) diameter. Rectangular keys are recommended for larger shafts. Standard taper on taper keys is 1:100 (1/8 inch per foot). *Source:* Hamilton's Gear Book
- The width of a key should be ¼ the shaft diameter. *Source:* Jack de la Vergne
- Drum shafts (or other shafts for frequently reversed motion) should not have any key at all. Hubs, couplings, and the like should instead be shrink fitted to the shaft. Removal by the oil injection method is recommended. *Source:* Sigurd Grimestad
- For geared drives, pinion gears should have a minimum number of 12 teeth and preferably not less than 17. If the pinion has less than 17 teeth, undercutting may occur and the teeth should be cut *long addendum* ("addendum" is the distance between the pitch line and the crown of the tooth). *Source:* Hamilton's Gear Book
- For geared drive drum hoists, pinion gears should have a minimum number of 14 teeth. *Source:* Ingersoll Rand

Overwind and Underwind

- The overwind distance required for a drum hoist is one foot for every hundred fpm of hoist line speed. *Source:* Tad Barton
- The overwind distance required for a drum hoist is 1.6 feet for every hundred fpm (1m for every 1m/s) of hoist line speed, to a maximum of 10m. *Source:* Sigurd Grimestad
- The overwind distance required for a high-speed drum hoist is 7m. *Source:* Peter Collins
- The underwind distance required is normally equal to ½ the overwind distance. *Source:* Jack de la Vergne

Hoist Inertia

- The residual inertia of a double-drum hoist (including the head sheaves and motor drive, but not ropes and conveyances), reduced to rope centre, is approximately equal to the weight of 10,300m (33,800 feet) of the hoist rope. For example, the approximate inertia (WR^2) of a 10-foot double-drum hoist designed for 1½ inch diameter stranded ropes weighing 4 lbs. per foot, will be:

$$5 \times 5 \times 4 \times 33,800 = 3,380,000 \text{ lbs-feet}^2.$$

Source: Tom Harvey

- The inertia of a single-drum hoist may be assumed to be 2/3 that of a double-drum hoist of the same diameter. *Source:* Ingersoll-Rand
-

Hoist Inertia (continued)

- The inertia (in lbs-feet²) of the rotor of a direct current (DC) geared drive hoist motor is approximately equal to 1,800 times the horsepower of the motor divided by its speed (RPM) to the power of 1.5:

$$WR^2 = 1800 [\text{HP/RPM}]^{1.5}$$

Source: Khoa Mai

- The inertia (in lbs-feet²) of the rotor of a DC direct drive hoist motor is approximately equal to 850 times the horsepower of the motor divided by its speed (RPM) to the power of 1.35:

$$WR^2 = 850 [\text{HP/RPM}]^{1.35}$$

Source: Khoa Mai

Root Mean Square Power

- Power consumption (energy portion of utility billing) of a drum hoist is approximately 75% of root mean square (RMS) power equivalent. Source: Unknown
- In calculating the RMS horsepower requirements of a drum hoist, it is not important to determine a precise value for the inertia. A 10% error in inertia results in a 2% error in the RMS horsepower. Source: Tom Harvey

Peak Power

- For a DC hoist motor, the peak power should not exceed 2.1 times the RMS power for good commutation. Source: Tom Harvey
- For a DC hoist motor, the peak power should not exceed 2.0 times the rated motor power for good commutation. Source: Sigurd Grimstad
- A typical AC induction hoist motor is supplied with a 250% breakdown torque. In application, this means that the peak horsepower should not exceed 1.8 times the RMS power. Source: Larry Gill

Delivery

- The delivery time for a new drum hoist is approximately 1 month per foot of diameter (i.e. for a 12-foot double-drum hoist, the delivery time is approximately 12 months). Source: Dick Roach
- The delivery time for new wire ropes for mine hoists is approximately four months for typical requirements. For special ropes manufactured overseas, delivery is near six months. Source: Khoa Mai

13.3 Tricks of the Trade

- The easy way to design a drum hoist is to first determine the required hoisting speed and payload, then determine the rope that is needed to meet the SF. The hoist parameters can then all be determined only considering the hoist rope and line speed. Source: Tom Harvey
- For purposes of initial design, the hoist line speed should be 40% of the highest speed that is theoretically obtainable over the hoisting distance (even though the most economic speed is 50%). This value leaves room to increase the speed at some future date to as high as 60% without seriously compromising power costs. Source: ASEA (now ABB)
- The statutory minimum drum diameter to rope diameter ratios have been deleted from MSHA regulations; however, the ratios remain intact in the ANSI guidelines and these should be incorporated into the specifications for a proposed drum hoist installation at normal hoisting speeds. Source: Julian Fisher
- Where guidelines indicate an 80:1 drum to rope ratio, it may be reduced to 72:1 at hoisting speeds up to 2,000 fpm (10m/s) without significant loss of rope life when employing stranded wire ropes on drum hoists. For speeds exceeding 3,000 fpm (15m/s), the minimum drum diameter to rope diameter ratio is 96:1. At this minimum, the head sheave diameter to rope diameter ratio may be increased to 120:1 as an inexpensive means to help maintain good rope life. Source: Largo Albert
- The overwind distance is normally first calculated for the minimum statutory requirement and then increased if required to meet good engineering practice. Source: Jack de la Vergne
- For deep shafts, the overwind distance calculated must include an allowance for less turns of the hoist drum that result from hoisting an empty skip. Hoist controllers don't know where the conveyance is; they precisely track the revolutions of the hoist drum. Source: Largo Albert

- A modern hoist with automatic compensation of the rope stretch and variations in drum diameter does not require an overwind allowance related to hoisting an empty skip. *Source:* Sigurd Grimestad
- The inertia of the drive motor rotor must be multiplied by the square of the gear ratio for the effect at drum radius. *Source:* John Maude
- An easy way to obtain an accurate value for the RMS horsepower of a counterweight hoisting system (round trip) from a computer program designed for balanced skip hoisting (one-way trip) is by making two runs. The first run hoists the full payload and the second hoists the counterweight while lowering the empty conveyance. The RMS horsepower for the round trip may then be obtained from averaging the heating values:

$$\text{RMS HP} = [(\text{HP}_1^2 + \text{HP}_2^2)/2]^{1/2}$$

Source: Jack de la Vergne

- An easy way to obtain a value for the RMS horsepower of a double-drum sinking hoist from a computer program designed for balanced skip hoisting is to substitute the sums of the stop and creep times in the sinking cycle for those of the skipping cycle. *Source:* Jack de la Vergne
- The RMS horsepower calculation is not always the criteria for selecting the drive for a drum hoist installation. When hoisting single from a deep horizon (or balanced hoisting from great depths), if the peak horsepower exceeds the RMS by a wide margin, the peak horsepower may be the basis for selecting the size of the hoist drive. *Source:* Jack de la Vergne
- In the selection of a suitable motor for any hoist, the peak demand, RMS demand, and creep speed demand should be considered. Also, selection should be based on torque rather than power. *Source:* Sigurd Grimestad
- For drum hoists, fleet angles of 1 in 45 (1° 16') or 1 in 50 (1° 9') are desirable. *Source:* Henry Broughton
- The fleet angle for drum hoists should not exceed 1° 30'. *Source:* Ingersoll Rand
- In mine-shaft hoisting, the maximum fleet angle should be as close as possible to 1° 20'. Excessive drum wear and poor spooling will result if this angle is exceeded. *Source:* Wire Rope Industries
- Ideally, the fleet angle should not exceed 1° 15'. Some line scrubbing will occur in the zone between this angle and 1° 30', but at a wider angle the rope may pull away from the flange or jump at high speed. *Source:* Lebus International
- The maximum fleet angle should not exceed 2°. *Source:* South African Bureau of Standards (SABS 0294)
- For large hoist installations, vibration analysis is likely to reveal that to avoid excessive rope whip, a drum hoist should be closer to the headframe than the traditional maximum desirable fleet angle will allow. In such a case, it may be considered that selection of the appropriate rope lay (right hand or left hand), a wide pitch distance for the rope grooves, and the installation of a miscoil detection device may permit employment of a wider fleet angle than the limits once thought to be necessary. *Source:* Jack de la Vergne
- A minimum fleet angle of 30' for a drum hoist will ensure that the rope will cross back and start a new layer without piling. *Source:* Fred Edwards
- Ideally, the minimum fleet angle should not be less than 15'. In the zone between this angle and zero, there may be trouble to kick or turn the rope back for the next layer. *Source:* Lebus International
- The minimum fleet angle should not be less than 15'. *Source:* South African Bureau of Standards (SABS 0294)
- You have only to consider a tower mounted auxiliary drum hoist over a deep shaft (that operates without an intermediary sheave) to realize that the minimum acceptable fleet angle is zero. *Source:* Cass Atkinson
- In practice, the minimum fleet angle must never be negative, but it may be near to zero at slow hoisting speeds. *Source:* Jack de la Vergne
- Optimization of fleet angle geometry is obtained when the axes of the head sheaves are aligned to aim the sheave flight at the center of the face of the hoist drums rather than have the flights exactly parallel. *Source:* Largo Albert

13.4 Hoist Cycle Time "T"

One of the important aspects of hoisting is determining the cycle time. For an existing installation, it may be measured with a stopwatch or determined with a portable hoist trip recorder. The cycle time must be determined to design and specify a proposed hoist and, for this purpose, a simulated hoist cycle is calculated. The simulated cycle enables prediction of the hoist production and the capacity of the drive motor(s).

The hoist cycle time is the time taken for one complete trip. It is usually measured in seconds. The cycle is different for skipping, caging, or shaft sinking. For balanced hoisting (i.e. two skips), it is a one-way trip. For single hoisting or counterweight hoisting, the cycle is a round trip (up and down).

The cycle consists of the following components.

- Creep speed – typically 2 feet/second, except for cage hoists that creep at 1 foot/second.
- Acceleration – rate typically varies with line speed.
- Full speed – maximum rated or controlled line speed of hoist.
- Retardation – rate typically varies with line speed.
- Rest – Stop: 10-15 seconds for skip, 30-45 seconds for cage.

For hoisting skips or sinking buckets in balance, the cycle time, T (in seconds), can be accurately simplified to the following formula.

$$T = H/V + V/a + \text{stops} + \text{creep times} \dots \dots \dots (1)$$

In which

- H is the hoisting distance in meters (or feet)
- V is the full line speed in meters/second (or feet per second)
- a is the average of acceleration and retard rates in m/s/s (or feet per second/second)

Stops are rest periods at the pocket, dump, or hanging mark (in seconds), and creep times are the sum of the duration of travel at creep speed (in seconds).

The acceleration and retard rates may be adjusted for a particular installation. Only for purposes of general cycle calculations, it can be assumed that they are equal and proportional to the hoist speed.

$$a = V/15$$

In which

- a is feet/second/second (or m/s/s)
- V is feet per second (or m/s)

This permits a further simplification that is satisfactory to determine the hoist cycle for balanced hoisting.

$$T = H/V + 15 + \text{stops} + \text{creep times}$$

13.4.1 Stops

The stops for balanced hoisting with skips include simultaneous loading and dumping. This is traditionally assumed to be 10 or 12 seconds but ought to be increased to 15 seconds or more when automatic hoisting is employed. The extra time is required for PLC proving before and after the skip is loaded. The stop time for cage hoisting is taken at 30 seconds for a small cage and 45 seconds for a large one. The sum of the stop times for double-drum shaft sinking may be taken as 45 seconds.

13.4.2 Creep Times

The creep times for skip hoisting applications is usually taken as equal to 5 seconds at the beginning and 5 seconds at the end of the wind (“creep out” and “creep in”). For deep shafts, the creep out can be omitted, but the creep in is typically increased to 15 or even 20 seconds for high-speed hoisting from deep shafts, to provide an extra safety margin. For cage hoisting, the creep out can be omitted, but the creep in may be increased to 10 seconds to allow for spotting the deck. The sum of the creep in times for shaft sinking in North America with a double-drum hoist may be taken as 65 seconds, and for creep out it totals about 40 seconds.

With these considerations, formulae for the hoisting cycles (in seconds) of different drum hoisting applications (valid for use with either metric or imperial units) can be derived as follows.

Typical shaft skip hoisting in balance

$$T = H/V + 35 \quad (\text{manual})$$

Typical shaft skip hoisting in balance

$$T = H/V + 40 \quad (\text{automatic})$$

Deep shaft skip hoisting in balance

$$T = H/V + 45 \quad (\text{automatic})$$

Shaft sinking in balance

$$T = H/V + 165 \quad (\text{North America})$$

Shaft sinking in balance

$$T = H/V + 135 \quad (\text{South Africa}^*)$$

Small cage and counterweight hoisting

$$T = 2H/V + 100 \quad (\text{round trip})$$

Large cage and counterweight hoisting

$$T = 2H/V + 130 \quad (\text{round trip})$$

Single drum shaft sinking (North America)

$$T = 2H/V + 215 \quad (\text{round trip})$$

* South African shaft sinkers employ a creep speed higher than 2 feet/second.

Note

At installations where skips are hoisted on rope guides, the cycle time may have to be modified to account for slow down at the ends of travel required for the transition from rope guides to fixed guides. An entry speed of 300 fpm (1.5m/s) is considered desirable although there are installations that have been carefully engineered to permit a faster transition speed (as high as 1,100 fpm).

13.5 Maximum Line Speeds for Drum Hoists

The speed selected for a proposed drum hoist installation is first selected on the basis of economics. This speed is determined with sufficient accuracy by applying a rule of thumb formula (Cooper or Ingersoll Rand formulae provided above). A practical limit exists to the hoisting speed that may be employed. This maximum speed may be determined by rule of thumb and by investigating the maximum speeds employed at existing operations elsewhere.

13.5.1 Case Histories

Tables 13-1 and 13-2 show case histories on hoisting speeds on wood and fixed guides.

Table 13-1 Hoisting Speeds on Wood Guides – Exceeding 10m/s (2,000 fpm)

Mine	Shaft	Skip Capacity	Hoisting Speed	Hoisting Speed	Guide Type
INCO-Copper Cliff ¹	North	15.00 tons	15.2 m/s	3,000 fpm	Wood
INCO –Stobie*	7	10.00 tons	15.2 m/s	3,000 fpm	Wood
INCO-Levack	2	12.00 tons	14.2 m/s	2,800 fpm	Wood
INCO- Garson	2	10.00 tons	11.2 m/s	2,205 fpm	Wood
INCO- Froot	3	12.00 tons	12.2 m/s	2,400 fpm	Wood
Teck Corona	David Bell	7.00 tons	11.4 m/s	2,250 fpm	Wood
Macassa	No.3		11.2 m/s	2,200 fpm	Wood
Pamour	14	5.00 tons	12.2 m/s	2,400 fpm	Wood
Rio Algom	Stanleigh	15.00 tons	14.6 m/s	2,880 fpm	Wood
Lac Dufault	Corbet	10.00 tons	13.2 m/s	2,600 fpm	Wood

¹ These shafts are now operated at a slower line speed than reported in the table.

Table 13-2 Hoisting Speeds on Fixed Guides (Steel), Exceeding 15m/s (3,000 fpm)

Mine	Shaft	Skip Capacity	Hoisting Speed	Hoisting Speed	Guide Type
INCO-Creighton	No.9	16.00 tons	16.8 m/s	3,300 fpm	HSS
INCO-Copper Cliff	South	17.00 tons	16.8 m/s	3,300 fpm	HSS
Falco - Onaping	Craig		18.3 m/s	3,600 fpm	HSS
Buffelsfontein	East Primary	13.10 tons	18.3 m/s	3,600 fpm	Top Hat
West Driefontein	4	9.00 tons	16.0 m/s	3,150 fpm	Top Hat
West Driefontein	6	10.00 tons	16.0 m/s	3,150 fpm	Top Hat
East Driefontein	2	17.20 tons	18.3 m/s	3,600 fpm	Top Hat
East Driefontein	1	13.60 tons	18.0 m/s	3,550 fpm	Top Hat
Deelkraal	1	21.00 tons	18.3 m/s	3,600 fpm	Top Hat
Elandsrand	Rock Vent	12.50 tons	16.0 m/s	3,150 fpm	Top Hat
Western Holdings	Saaiplaas 2	11.80 tons	17.8 m/s	3,500 fpm	Channel
Western Holdings	Saaiplaas 3	21.00 tons	16.0 m/s	3,150 fpm	Top Hat
President Brand	3	9.10 tons	16.0 m/s	3,150 fpm	Top Hat
South Deep	man/mat	27.00 tons	18.0 m/s	3,550 fpm	HSS
Vaal Reefs	7	9.25 tons	16.0 m/s	3,150 fpm	Top Hat
Vaal Reefs ¹	11	skip	19.2 m/s	3,780 fpm	HSS
Vaal Reefs ¹	11	cage	19.0 m/s	3,740 fpm	HSS

¹ Now named Moab Khotsong

13.6 Production Availability

Confusion and controversy exists in the mining industry when defining the word “availability” as applied to mine hoists. For hoist maintenance personnel, it may mean the percent of the time the piece of equipment is available to work compared with the total time available. On the other hand, those engaged in selecting and evaluating hoists for mine service must consider the availability of the total hoist system, taking not only maintenance downtime into account, but also downtime due to shaft repairs, power outages, rope dressing, skip change-out, etc. This chapter is concerned with the availability of the total system, and for this purpose, it is described as “production availability.”

To determine the production availability of a double-drum hoist for purpose of estimating hoisting capacity per day, a detailed calculation should be made for each case, taking into account the total hoisting system. This will include allowances for empty loading pocket, full bin, hoisting spill, etc. It will usually be equivalent to approximately 16 hours of hoisting per day (67%), for a seven day per week operation. For a five or six day per week operation, it may be 18 hours per day (75%) because some maintenance work can be performed on the weekend.

Example

- Facts:
1. Estimate is based on a seven-day workweek
 2. Automatic hoisting is assumed.
 3. No cage service is required
 4. 12-day annual shutdown is assumed

Solution:

Hoist plant availability is shown in Table 13-3.

Table 13-3 Hoist Plant Availability – Double-Drum Hoist (Seven Days per Week Operation)

Activity	Skipping Continued?	Frequency	Duration (hours)	Factor	Equivalent Hrs/Week	Remarks
Work in Shaft						
Shaft Inspection	no	weekly	8	1.000	8.00	
Manway Inspection	N/A	monthly	N/A	0.000		During inspection
Hoist from spill pocket	yes	N/A	N/A	1.000		No spill pocket
Hoist spill from spill ramp	yes	weekly	0.9	1.000	0.90	½% spill
Skip Hoisting						
Shift change	yes	daily	N/A	0.000		Automatic hoist
Lunch time	yes	daily	1.5	0.000		Automatic hoist
21st shift in the week	no	weekly	8	1.000	8.00	
Change from ore to rock	no	daily	0.5	7.000	3.50	
Change back to ore hoisting	no	(in above)				
Electrical/Mechanical						
Daily mechanical hoist inspection	no	daily	1	7.000	7.00	
Inspection of skips and attachments	no	daily	(included above)			
Inspection of ropes	no	daily	(included above)			
Weekly mech. running tests	no	weekly	1	1.000	1.00	
Weekly electrical inspection	no	weekly	4	1.000	4.00	
Grease both ropes	no	monthly	2	0.231	0.46	
Replace scroll wear plates	no	annually	During Annual Shutdown			
EM Test of the ropes	no	quarterly	2	0.077	0.15	
Cage Drop Test	no	quarterly	2	0.077	0.15	
Recap hoist ropes	no	semi-annual	12	0.038	0.46	
Major Hoist Electrical	no	annually	During Annual Shutdown			
Major Drive Electrical	no	annually	During Annual Shutdown			
Major Hoist Mechanical	no	annually	During Annual Shutdown			
Change skip @ 500,000 tons	no	500,000 tons	12	0.098	1.17	
Change-out cage	no	5 years	During Annual Shutdown			
Change Counterweight	no	5 years	During Annual Shutdown			
Annual maintenance allowance for shaft signals	no	annually	During Annual Shutdown			
Headframe Annual Inspection maintenance	no	annually	During Annual Shutdown			
Inspect & adjust head sheaves for 2 skip ropes	no	annually	During Annual Shutdown			
Change one skip rope & groove head sheaves	no	36 months	During Annual Shutdown			
Change other skip rope & groove head sheaves	no	36 months	During Annual Shutdown			
Change cage rope	no	4 years	During Annual Shutdown			
Change counterweight rope	no	4 years	During Annual Shutdown			
NDT on hoist brakes, pins, shafts, etc.	no	annually	During Annual Shutdown			
Delays						
Load-out delays, Ore Bin full	no	per week	2	1.000	2.00	
Repairs to underground ore handling	no	per month	4	0.231	0.92	
Loading Pocket delays	no	per week	6	1.000	6.00	
Loading Pocket maintenance and repair	no	per month	8	0.231	1.85	
PLC proving bugs	no	per week	4	1.000	4.00	

Table 13-3 Hoist Plant Availability – Double-Drum Hoist (Seven Days per Week Operation) (continued)

Activity	Skipping Continued?	Frequency	Duration (hours)	Factor	Equivalent Hrs/Week	Remarks
Delays (continued)						
Fault Finding	no	per week	2	1.000	2.00	
Repairs to surface conveyors, bins, etc.	no	per month	4	0.231	0.92	
Delays for slinging	no	per week	0	1.000	0.00	use cage hoist
No muck - system empty	no	per month	4	0.231	0.92	
Power outages	no	per month	3	0.231	0.69	
Shaft bottom pumps repair	no	weekly	0	1.000	0.00	
Shaft bottom clean-up	no	quarterly	8	0.077	0.62	
Misc. delays (unidentified)	no	weekly	4	1.000	4.00	
Total Weekly Downtime (hours)					59 hours	
Total Hours in a Week (7 days x 24 hours)					168 hours	
Remaining Time to Skip (hours/week)					109 hours	
PRODUCTION AVAILABILITY					65.0%	

Example

Determine the skip capacity required for a double-drum hoist.

- Facts:
1. Production Availability = 65%
 2. Production capacity required = 4,500 tpd (ore and rock)
 3. Hoisting distance (lift), H = 2,025 feet
 4. Fully automatic hoisting
 5. 24 hours per day operation

- Solution:
1. Optimum line speed, $V = 44 \times \sqrt{2025} = 1,980 \text{ fpm} = 33\text{FPS}$
 2. Cycle Time, $T = H/V + 40 = 2025/33 + 40 \approx 100 \text{ seconds}$
 3. Trips per hour = $3,600/100 = 36$
 4. Trips per day = $36 \times 24 \times 65\% = 562$
 5. Skip capacity = $4,500/562 = 8 \text{ tons}$

Notes

- Refer to Chapter 15 to determine the hoist rope required for a skip capacity of 8 tons and subsequent determination of drum hoist design parameters for this example.
- Refer to Chapter 23 for electrical considerations and the determination of power consumption of a drum hoist drive.

Appendix

1.0 Derivation of formula for hoist cycle time:

$$T = H/V + V/a + \text{stops} + \text{creep times} \dots \dots \dots (1)$$

Nomenclature (Imperial or metric units)

- a = acceleration
- H = hoisting distance = $2s_1 + s_2$.
- r = retardation
- T = cycle time (seconds) = $2t_1 + t_2 + \text{creep time} + \text{stop time}$
- V = full line speed

Procedure:

1. Assume $a = r$
2. Determine distance traveled during acceleration and retardation, s_1 .
3. Determine distance traveled at full speed, s_2 .
4. Determine time elapsed during acceleration and retard, t_1 .
5. Determine time elapsed during full speed, t_2 .
6. Add up the elapsed time, $2t_1 + t_2$.

Solution:

1. $t_1 = V/a$
2. $t_2 = (H - 2s_1)/V = H/V - at^2/V = H/V - at^2/V = H/V - aV^2/Va^2 = H/V + V/a$
3. $2t_1 + t_2 = 2V/a + H/V - V/a = H/V + V/a$

Therefore:

$$T = H/V + V/a + \text{stops} + \text{creep times} \dots \dots \dots (1)$$

14.0 Koepe / Friction Hoists

14.1 Introduction

The friction (or Koepe) hoist is a machine where one or more ropes pass over the drum from one conveyance to another, or from a conveyance to a counterweight. In either case, separate tail ropes are looped in the shaft and connected to the bottom of each conveyance or counterweight. The use of tail ropes lessens the out-of-balance load and hence the peak horsepower required of the hoist drive. When compared with a drum hoist for the same service, the tail ropes reduce the required motor HP rating by about 30%, but the power consumption remains virtually the same. Tail ropes have been used for a few double-drum hoist installations to the same effect, but this practice has not gained acceptance by the mining industry.

Because they normally use several hoisting ropes, the largest friction hoists can handle heavier payloads than the largest drum hoists. The drum hoists are normally limited to the capacity of a single rope.

By statute, friction hoists usually require a higher SF on the hoist (head) ropes and most experts consider them impractical for very deep shafts.

For mine applications, Koepe hoists compete with drum hoists and the decision concerning which one is best suited for a particular application is considered in the example presented as a side study in Chapter 6 – Feasibility Studies.

Drum hoists are discussed separately in Chapter 13. The hoist cycle times developed for drum hoists in that chapter have equal application to friction hoists.

For historical reasons, friction hoists (unlike drum hoists) are usually thought of in terms of metric rather than imperial (British) units. To describe the size of a friction hoist people will say “a 3m wheel diameter” rather than “a 10-foot hoist.” For this reason, the explanations and design calculations that follow are mainly performed in metric units of measure.

14.2 Rules of Thumb

Hoisting Distance

- A friction hoist with two skips in balance is normally suitable for hoisting from only one loading pocket horizon and for a hoisting distance exceeding 600m (2,000 feet). Otherwise, a counter-balanced friction hoist (conveyance and counterweight) is usually employed (for multi-level, shallow lifts, or cage hoisting). *Source:* Ingersoll-Rand

- A friction hoist with two skips in balance may be suitable for a hoisting distance as shallow as 400m (1,300 feet). *Source:* Sigurd Grimstad

- The practical operating depth limit for a friction hoist is 1,700m (5,600 feet) for balanced hoisting and 2,000m (6,600 feet) for counterweight hoisting. Beyond these depths, rope life may be an expensive problem. *Source:* Jack de la Vergne

- The hoisting ropes (head ropes) for a friction hoist are not required to be non-rotating for depths of hoisting less than 800m (2,600 feet) provided right hand and left hand lays are employed to cancel rope torque effect. Tail ropes must always be non-rotating construction and connected with swivels at each end. *Various Sources*

Static Tension Ratio

- For a tower-mounted skip hoist, the calculated static tension ratio (T_1/T_2) should not exceed 1:1.42, but 1:1.40 is preferable. For a ground mounted skip hoist, the calculated static tension ratio should not exceed 1:1.44 but 1:1.42 is preferable. For a cage hoist installation, these values may be exceeded for occasional heavy payloads of material or equipment transported at reduced speed. *Various Sources*

- Twenty-two years of experience with operation of seven tower mount Koepe hoist installations has taught me that the T1/T2 ratio should be kept below 1.4:1 to avoid slippage and unsafe operation as a consequence. *Source:* Alex Murchie

Tread Pressure

- Tread pressure should not exceed 17.5 kg/cm² (250 psi) for stranded ropes and 28 kg/cm² (400 psi) for locked coil ropes. *Source:* A.G. Gent
-

Tread Pressure (continued)

- For lock coil hoist ropes, the tread pressure calculated for skip hoists should not exceed 2,400 kPa (350 psi), or 2,750 kPa (400 psi) for a cage hoist when considering occasional heavy payloads of material or equipment. *Source:* Jack de la Vergne
- For stranded hoist ropes, the tread pressure calculated for skip hoists should not exceed 1,700 kPa (250 psi) or 2,000 kPa (275 psi) for a cage hoist when considering occasional heavy payloads of material or equipment. *Source:* Largo Albert
- For flattened (triangular) strand headropes hoisting in balance, a tread pressure up to at least 2,200 kPa (319 psi) seems to be quite satisfactory. *Source:* Sigurd Grimestad

Tail Ropes

- The natural loop diameter of the tail ropes should be equal to or slightly smaller than the compartment centres. *Source:* George Delorme

Hoist Wheel Rotation

- The total number of friction hoist wheel revolutions for one trip should be less than 100 for skip hoists, but may be as high as 140 for cage hoists. *Source:* Wire Rope Industries and others
- To keep the load distribution between the ropes to an acceptable limit, the number of revolutions of the hoist wheel for one trip should not exceed 125 for any multi-rope friction hoist. *Source:* Sigurd Grimestad
- The hoist wheel rotation at full speed should not exceed 75 RPM for a geared drive, or 100-RPM for a direct drive. *Source:* Ingersoll-Rand

Position

- The distance between the hoist wheel and the highest position of the conveyance in the headframe should not be less than 1.5% of the distance from the hoist wheel to the conveyance at the lowest point of travel. *Source:* Largo Albert
- At full speed, a time increment of at least ½ a second should exist as any one section of rope leaves the hoist wheel before experiencing the reverse bend at the deflector sheave. *Source:* George Delorme
- The clearance between the bottom of the conveyance at the lowest normal stopping destination in the shaft, and the top of the shaft bottom arrester (first obstruction) is usually 5 feet. This arrangement ensures that the weight of the descending conveyance is removed from the hoist ropes. *Source:* Largo Albert
- The tail rope loop dividers are generally placed below the arrester. The bottoms of the tail rope loops are then positioned 10 to 15 feet below the dividers. Beneath this, a clearance of about 10 feet will allow for rope stretch, etc. *Source:* Largo Albert

Hoist Speed

- Where the hoist line speed exceeds 15m/s (3,000 fpm), the static load range of the head ropes should not be more than 11.5% of their combined rope breaking strength. The (ratio of) hoist wheel diameter to rope (stranded or lock coil) diameter should not be less than 100:1, and the deflection sheave diameter to rope diameter should not be less than 120:1. *Source:* E J Wainright
- The maximum desirable speed for a friction hoist is 18m/s (3,600 fpm). *Source:* Jack Morris
- The maximum attainable speed for a friction hoist that can be safely obtained with today's (1999) technology is 19m/s (3,800 fpm). *Source:* Gus Suchard
- In North America, the desirable speed for cage service is approximately 2/3 of the optimum speed calculated for a skip hoist for the same hoisting distance. *Source:* Jack de la Vergne

Hoist Wheel Specifications

- The hoist wheel diameter to rope (lock coil) diameter should not be less than 100:1 for ropes up to 1-inch diameter, 110:1 for ropes to 1½ inches diameter, and 120:1 for ropes to 2 inches diameter. *Source:* Glen McGregor
 - A ratio of 100:1 (wheel diameter to lock coil rope diameter) is adequate for ropes of 25-35mm diameter. This should increase to 125:1 for ropes of 50-60mm diameter. *Source:* Jack Morris
-

Hoist Wheel Specifications (continued)

- Rope tread liners on the hoist wheel should be grooved to a depth equal to one-third (1/3) of the rope diameter when originally installed or replaced. The replacement (discard) criterion is wear to the point that there is only 10mm (3/8 inch) of tread material remaining, measured at the root of the rope groove. *Source: ASEA (now ABB)*
 - On most friction hoist installations, the maximum tolerable groove discrepancy is 0.004 inches, as measured from collar to collar. *Source: Largo Albert*
-

Production Availability

- A friction hoist is available for production for 108 hours per week. This assumes the hoist is manned 24 hours per day, seven days per week, and that muck is available for hoisting. *Source: Jack Morris*
 - With proper maintenance planning, a friction hoist should be available 126 hours per week (18 hours per day). *Source: Largo Albert*
-

Spacing

- The minimum distance (design clearance) between a rope and bunton or divider is 5 to 6 inches. This is mainly because the hoist rope vibration is normally 2 to 3 inches off centre; 4 inches is considered excessive. *Source: Humphrey Dean*
 - The spacing between head ropes should be 1 inch for each foot diameter of the hoist wheel to get an adequate boss for the deflection sheave. *Source: Gerald Tiley*
-

14.3 Tricks of the Trade

- The easy way to design a friction hoist is to first determine the required hoisting speed and payload then determine the ropes that are needed to meet the required SF. The hoist parameters can then all be determined only considering the hoist ropes and line speed. *Source: Tom Harvey*
- The distinguishing feature that should be recalled when designing or operating a friction hoist is that “weight is your friend.” In other words, heavier ropes and suspended loads mean higher force of friction and greater facility for braking, etc. *Source: Richard Mclvor*
- The rule of thumb (attributed to Wainright) that indicates a minimum SF of 7 for friction hoist head ropes is not correct. There are a very large number of hoist installations worldwide that have operated satisfactorily for many years at smaller SFs. In this respect, the regulations stipulated for the Province of Ontario in Canada are a good guideline, anywhere. *Source: Largo Albert*
- The problem of short rope life in very deep shafts may be alleviated by a high factor of safety on the headropes and/or reducing the tailrope mass by 10-15%. *Source: Sigurd Grimestad*
- To avoid stress concentrations, it is desirable to manufacture a friction hoist wheel in one piece. Wheels up to about 3m (10 feet) in diameter can be shipped complete with shaft to most locations. *Source: Gerald Tiley*
- When designing a tower-mounted friction hoist, consideration should be given to the possible avoidance of deflection sheaves, as they represent a maintenance headache. *Source: Richard Mclvor*
- At full speed, a time increment of 0.6 second should exist as any one section of rope leaves the hoist wheel before experiencing the reverse bend at the deflector sheave. This adds to the headframe height, but the added clearance is desirable for maintenance and change-out of the sheave wheels. *Source: Largo Albert*
- While it is better to have the rope spacing the same at the hoist wheel and the head sheaves for a ground mounted Koepe hoist, this is not necessary provided that the fleet angle of the outside ropes is 1° or less. This is known because there are single rope friction hoists in Europe with both head sheaves on the same headframe deck that operate satisfactorily, provided the fleet angle is maintained at 60 minutes (1°) or less. *Source: Tréfileurope*
- For a single rope ground-mounted Koepe hoist, it is better to have the head sheaves in the same plane as the hoist wheel. However, the head sheaves may be mounted on the same deck of the headframe tower, provided the fleet angle of the outside ropes is not more than 1½ to 2 degrees. *Source: Henry Broughton*
- While it is better to have the rope spacing the same at the hoist wheel and the skip attachment, this is not necessary provided the fleet angle of the outside ropes is 1° or less when the conveyance is at its upper end of travel. *Source: Borje Fredricksson*

- The arresters ("last resort") at the shaft bottom are designed to stop a full-speed conveyance at 2g, while an ascending conveyance must be stopped at less than 1g (i.e. 0.9g), although not necessarily from full speed if it exceeds 15m/s (3,000 fpm). *Various Sources*
- The tail ropes should be oriented to overcome the Coriolis effect. If placed in the East-West direction, the tail ropes will freely open and close. If the compartments are North and South, the ropes will foul the separating spacers (loop dividers) if not widely spaced. *Source: Gerald Tiley*
- The Coriolis effect can be neglected, as it is much smaller than the movement at acceleration/deceleration and due to rope torque of the tail ropes. *Source: Borje Fredricksson*
- High-speed friction hoists [over 12m/s (2,400 fpm)] are oriented with the wheel diameter East-West to minimize the effect of Coriolis acceleration on the tail ropes. *Source: Jack Morris*
- The effect of Coriolis acceleration on the tail ropes is diminished when a fixed guide system is employed, as opposed to using rope guides. *Source: Jack de la Vergne*
- The tail rope weight is normally designed equal to the head ropes; however, tail ropes slightly heavier than the head ropes will assist acceleration from the loading pocket. Slightly lighter tail ropes will provide a greater SF for the head rope section above the conveyance as it approaches the highest point of travel (the point at which uneven rope tension is most severe). *Source: Gerald Tiley*
- The distance between head ropes (spacing) varies between 8 inches and 12 inches. At 8 inches, some installations experience rope slap but this is not considered a serious problem, since the ropes are running at the same speed. (*Author note: regular slapping is said by others to lead to martensitic alteration, resulting in broken wires.*) Narrow rope spacing may require that the rope attachments at the conveyance be staggered. This can be accomplished by including a link at every other attachment. *Source: Humphrey Dean*
- The guideline for rope spacing is 8 inches up to $1\frac{1}{8}$ -inch rope diameter, 10 inches to $1\frac{1}{4}$ inches, 12 inches to $1\frac{1}{2}$, 14 inches to $1\frac{5}{8}$, and 16 inches to $1\frac{3}{4}$. Drawhead connections can be staggered but this is costly and complicates rope adjustment and maintenance. *Source: Largo Albert*

14.4 Friction Hoist Design

Listed below are the steps in designing and selecting a friction hoist.

1. Determine the SF required for the given hoist distance
2. Determine hoisting speed, V
3. Calculate the hoist cycle
4. Define (cage) or calculate (skip) the payload
5. Determine the weights of the conveyances required
6. Select hoist (head) ropes
7. Determine the wheel diameter of the hoist
8. Select balance (tail) ropes
9. Calculate the RMS power requirement

Example

Design and select two friction hoists at the same time. One is required for production hoisting and the other for cage service.

- Facts:
1. Both hoists will be tower mounted in the same headframe
 2. The skip hoist requires a capacity of 500 tonnes/hour
 3. The cage hoist requires a payload of 26 tonnes
 4. Each has a hoisting distance, H of 1,000m
 5. The statutory SFs of Ontario, Canada are to apply

Solution:

Step 1: Determine the SF required for the given hoist distance.

Following is the SF required by statute for the hoist ropes.

- $SF = 8 - .00164D$, but not less than 5.5, in which D = length of suspended rope.

- $D =$ approximately $H + 50\text{m}$ to account for rope suspended above the dump and beneath the loading pocket (in the case of a skip hoist) and similar extra rope length in the case of a cage hoist.
- $SF = 8 - (.00164 \times 1,050) = 6.3$

Step 2: Determine hoisting speed, V .

- The optimum skip hoisting speed, $V = 0.44 H^{1/2} = 14\text{m/s}$ (rounded)
- A suitable cage hoisting speed will be about $2/3 V = 10\text{m/s}$ (rounded up)

Step 3: Calculate the hoist cycle (refer to Chapter 13 for cycle formulae used).

Calculate the skip hoist cycle time, T and the number of trips per hour. (Since the hoisting distance exceeds 600m, balanced hoisting with two skips is determined.)

- $T = H/V + 45 = 1,000/14 + 45 = 116$ seconds
- Trips per hour $= 3,600/116 = 31.0$

Calculate the cage hoist cycle time, only (a cage and counterweight is assumed).

- $T = 2H/V + 130 = 330$ seconds

Step 4: Define (cage) and calculate (skip) payload.

The cage payload is given at 26 tonnes and the skip payload is calculated by dividing the capacity per hour by the trips per hour.

- Skip payload, $P = 500/31 = 16$ tonnes (rounded)

Step 5: Determine the weights of the conveyances required.

The weight of the cage for 26-tonne capacity will be approximately 20 tonnes if it is steel (steel is typical for friction hoists).

The weight of the counterweight will be made equal to the empty cage weight plus half the payload = 33 tonnes. (In this case, the counterweight will be designed to readily remove a portion of its weight for regular cage service with lighter payloads.)

The weight of the skip, S will be approximately 13 tonnes (refer to Table 15-2) for a steel bottom dump skip that would normally be used for this application. However, this weight might not be enough to maintain the required tension ratio (in this case, the skip would be "ballasted" with extra weight).

The empty weight of skip required to maintain a tension ratio of 1.40:1 follows.

- $S_t = P\{2.5 - (H \times SF/4,500)\} = 16 (2.5 - 1.4) = 17.6$ tonnes
- The skips will be ballasted to weigh 17.6 tonnes

Step 6: Select hoist (head) ropes.

Cage Hoist

Try 6 lock coil ropes of 32mm diameter weighing 5.58 kg/m and having a breaking strength (BS) of 890 kN.

- SF obtained = Number ropes \times BS/maximum suspended load
 $= 6 \times \text{BS}/\text{weight of ropes, payload and cage}$
 $= 6 \times 890/g (35.5 + 26 + 20) = 6.7$ (6.3 required)
- T_1/T_2 obtained = $(35.5 + 26 + 20)/(35.5 + 33) = 1.19$
- T_2/T_3 obtained = $(35.5 + 33)/(35.5 + 20) = 1.23$

Maximum total suspended load = $(35.5 + 26 + 20) + (35.5 + 33) = 150$ tonnes

Skip Hoist

Try four of the same lock coil ropes – 32mm diameter, 5.58 kg/m, and BS 890 kN.

- T_1/T_2 obtained = $(23.7 + 16 + 17.6)/(23.7 + 17.6) = 1.39$ (1.40, or less, desired)

Maximum total suspended load = $(23.7 + 16 + 17.6) + (23.7 + 17.6) = 98.6$ tonnes

- SF obtained = Number ropes \times BS/maximum suspended load
 $= 4 \times \text{BS}/\text{weight of ropes, payload and skip}$
 $= (4 \times 890/g(23.6 + 16 + 17.6) = 6.35$ (6.3 required)

Step 7: Determine the wheel diameter of the hoist, D.

The statutory requirement for lock coil ropes is 100 times the diameter of the hoist rope at this location.

Cage and Skip Hoist

(Statutory) $D = 100d = 100 \times 32 = 3,200\text{mm} = 3.2\text{m}$

The statutory diameter may not be sufficient. For example, the diameter should be increased if the permitted tread pressure is exceeded, the number of wheel revolutions per trip is too high, or the ropes are greater than 35-mm diameter.

The tread pressure is calculated by dividing the total suspended load by the projected contact area of the ropes on the hoist wheel. Tread pressure should not exceed 2,400 Kpa for a skip hoist or 2,750 kPa for a cage hoist with maximum payload.

- Cage hoist tread pressure = $150g \times 1,000 / (6 \times 3.2 \times 32) = 2394 \text{ kPa}$ (✓)
- Cage hoist revolutions = $H/\pi D = 1,000/3.2\pi = 99.5$ (✓)
- Skip hoist tread pressure = $98.6g \times 1,000 / (4 \times 3.2 \times 32) = 2360 \text{ kPa}$ (✓)
- Skip hoist revolutions = $H/\pi D = 1,000/3.2\pi = 99.5$ (✓)

A wheel diameter of 3.2m should be satisfactory for both hoists. (On detailed investigation, it may be increased to 3.5m to increase rope life).

Step 8: Select balance (tail) ropes.

Select non-rotating balance (tail) ropes matching the head rope weight and with a natural loop diameter equal to the compartment spacing.

Note

Tail ropes can be custom manufactured to meet precise weight requirements (i.e. kg/m).

For the cage hoist (assuming no deflection sheave), select three non-rotating ropes weighing twice the head rope weight.

The head ropes weigh 5.58 kg/m; therefore, the tail ropes will weigh 11.16 kg/m with a 53mm diameter. If the ropes are 34 by 7, the natural loop diameter will be $46 \times 53 = 2,438\text{mm}$ (unsatisfactory). If the ropes are 18 by 7, the natural loop diameter will be $60 \times 53 = 3,180\text{mm}$ (satisfactory).

For the skip hoist (assuming a deflection sheave is required to bring the conveyances closer together in the shaft, say 2m between compartment centres), select three non-rotating ropes of weight = $4/3 \times 5.58 = 7.44 \text{ kg/m}$ with a 43mm diameter. If they are 34 by 7, the natural loop diameter will be $46 \times 43 = 1,978\text{mm}$ (satisfactory).

Step 9: Calculate the RMS power requirement.

Assume there is a force-ventilated DC or cyclo-converter drive.

The skip hoist RMS power = a constant(k) x unit weight of the ropes x (speed)^{5/4}
SF obtained

- $k=24$ for a standard DC (FV) or cyclo-converter drive (FV)
- The skip hoist RMS power = $(24/6.35) \times 4 \times 5.58 \times 14^{1.25} = 2,284 \text{ kW}$ (3,064 HP)

Check

- Skip hoist RMS power = full speed power plus 5% = $16 \times 9.81 \times 14 \times 1.05 = 2,307 \text{ kW}$ (✓)
- The cage hoist RMS power = skip hoist factored for speed, cycle time and out-of-balance loads = $2,284 \times (10/14)^{1.25} \times (2 \times 116/330)^{0.5} \times 13/16 = 1,021 \text{ kW}$ (1,370) HP

This sample problem produces a result satisfactory for a basic engineering study. Where accurate design is required for the power train, it is recommended that a computerized hoist program be employed.

14.5 Tension Ratio

The tension ratio is the ratio between the suspended weight on the hoisting side and the descending side. It is referred to as the T_1/T_2 ratio, except in the case where a counterweight is hoisted while the empty conveyance descends (T_2/T_3). The determination of a safe ratio is an elegantly simple mathematical exercise; therefore, it is surprising that a controversy rages between European and North American hoisting experts as to the correct design value for this parameter.

50 years ago, when these hoists were first introduced to North America, it was universally agreed that a value of 1.45:1 was a safe, practical value. In the interim, Europeans maintained this value and even increased it (up to 1.50:1). At the same time, problems encountered in North America led to the adamant conclusion that the Tension Ratio ought not to exceed 1.40:1 to help ensure trouble-free operation of friction hoists (which at the time were all tower-mounted). Later, a number of ground-mounted friction hoists were installed in the USA with a value of 1.45:1, without subsequent problems. This phenomenon led to the logical conclusion that a ground-mounted friction hoist is less susceptible to problems blamed on the tension ratio employed. It is interesting to note that, while a credible argument is put forth to explain this position, an equally plausible argument demonstrates that a ground-mounted friction hoist ought to require a higher minimum tension ratio than a tower-mount.

Without going into details, it should be noted that there are a variety of related factors that affect the choice of tension ratios. Not the least of these is that European installations and USA ground-mount hoists employ stranded ropes, while North American tower-mount hoists usually employ full lock-coil ropes. These can withstand a higher tread pressure and thus are not as susceptible to limitations on the suspended load, which in turn relates to the tension ratio selection.

For purposes of this handbook, it is proposed that the conservative value (1.40:1) be employed as a design guideline for any friction hoist installation in North America. The increased cost (if any) normally only amounts to extra steel in the construction of the conveyance or counterweight (to make them heavier). In addition, the lower ratio is inherently safer since it permits a greater braking effort to be employed without the danger of incurring rope slip.

14.6 Production Availability

Confusion and controversy exists in the mining industry as to the meaning of the word “availability” when applied to mine hoists. For hoist maintenance personnel, it may mean the percent of the time the piece of equipment is available to work compared with the total time available. On the other hand, those engaged in selecting and evaluating hoists for mine service must consider the availability of the total hoist system, taking not only maintenance downtime into account, but also downtime due to shaft repairs, power outages, rope dressing, skip change-out, etc. This chapter is concerned with the availability of the total system, and for this purpose, it is described as “production availability.”

To determine the production availability of a friction hoist for the purpose of estimating hoisting capacity per day, a detailed calculation should be made for each case, taking into account the total hoisting system. This will include allowances for empty loading pocket, full bin, hoisting spill, etc. Availability will usually be slightly less than a drum hoist because the friction hoist demands a more sophisticated maintenance routine. Availability is higher in a five or six day per week operation (because some maintenance work can be performed on the weekend) than a seven day per week operating scenario.

Example

- Facts:
1. Estimate is based on a 7-day workweek
 2. Automatic hoisting is assumed
 3. Two skips are hoisted in balance
 4. No cage service is required
 5. 12-day annual shutdown is assumed

Solution:

The hoist plant availability is shown in Table 14-1.

Table 14-1 Hoist Plant Availability
(Friction/Koepe Hoist – Seven Day per Week Operation)

Activity	Skipping Continued?	Frequency	Duration (hours)	Factor	Equivalent Hrs/Week	Remarks
Work in Shaft						
Shaft Inspection	no	weekly	4	1.000	4.00	
LP inspection	no	weekly	2	1.000	2.00	
Shaft bottom inspection	no	weekly	2	1.000	2.00	
Manway inspection	N/A	monthly	N/A	0.000		During inspection
Hoist from spill pocket	yes	N/A	N/A	1.000		No spill pocket
Hoist spill from spill ramp	yes	weekly	0.9	1.000	0.90	½% spill

Table 14-1 Hoist Plant Availability (continued)

Skip Hoisting						
Lunch time	yes	daily	1.5	0.000		Automatic hoist
21st shift in the week	no	weekly	8	1.000	8.00	
Change from ore to rock	no	daily	0.5	7.000	3.50	
Change back to ore hoisting	no	(in above)				
Electrical/Mechanical						
Hoist brake test	no	shift	0.1	21.000	2.10	
Hoist over/underwind check	no	shift	(included above)			
Hoistman's shift inspection	yes	shift	(included above)			
Daily mechanical hoist inspection	no	daily	1	7.000	7.00	
Inspection of skips and attachments	no	daily	(included above)			
Inspection of ropes	no	daily	(included above)			
Dry run of skips	no	after shutdown	0.1	2.000	0.20	
Collar to collar test	no	weekly	1	1.000	1.00	
Rope stretch test	no	weekly	0.2	1.000	0.20	
Weekly mech. running tests	no	weekly	1	1.000	1.00	
Weekly electrical inspection	no	weekly	4	1.000	4.00	
Dress head ropes	yes	monthly	Dress while hoisting			Automatic
Dress balance ropes	no	monthly	5	0.231	1.16	
Replace scroll wear plates	no	annually	During Annual Shutdown			
EM Test of the ropes	no	quarterly	2	0.077	0.15	
Recap hoist ropes	no	semi-annual	12	0.038	0.46	
Major Hoist Electrical	no	annually	During Annual Shutdown			
Major Drive Electrical	no	annually	During Annual Shutdown			
Major Hoist Mechanical	no	annually	During Annual Shutdown			
Change skip @ 500,000 tons	no	500,000 tons	8	0.076	0.61	
Detailed check of rope attachments	no	semi-annual	8	0.038	0.30	
Change hoist tread liners	no	semi-annual	6	0.038	0.23	
Replace worn loop dividers	no	semi-annual	During shaft inspection			
Re-groove deflection sheave or change liners	no	semi-annual	8	0.038	0.30	
Annual maintenance allowance for shaft signals	no	annually	During Annual Shutdown			
Headframe Annual Inspection maintenance	no	annually	During Annual Shutdown			
Inspect & adjust deflection sheave	no	annually	During Annual Shutdown			
Change-out head ropes and adjust linkage	no	36 months	During Annual Shutdown			
Change-out tail ropes	no	48 months	During Annual Shutdown			
NDT on hoist brakes, pins, shafts, etc.	no	annually	During Annual Shutdown			

Table 14-1 Hoist Plant Availability (continued)

Delays						
Load-out delays, Ore Bin full	no	per week	2	1.000	2.00	
Repairs to underground ore handling	no	per month	4	0.231	0.92	
Loading Pocket delays	no	per week	6	1.000	6.00	
Loading Pocket maintenance & repair	no	per month	8	0.231	1.85	
PLC proving bugs	no	per week	4	1.000	4.00	
Fault Finding	no	per week	2	1.000	2.00	
Repairs to surface conveyors, bins, etc.	no	per month	4	0.231	0.92	
Delays for slinging	no	per week	0	1.000	0.00	use cage hoist
No muck - system empty	no	per month	4	0.231	0.92	
Power outages	no	per month	3	0.231	0.69	
Shaft bottom pumps repair	no	weekly	0	1.000	0.00	
Shaft bottom clean-up	no	quarterly	8	0.077	0.62	
Miscellaneous delays (unidentified)	no	weekly	4	1.000	4.00	
Total Weekly Downtime (hours)					63	hours
Total Hours in a Week (7 days x 24 hours)					168	hours
Remaining Time to Skip (hours/week)					105	hours
PRODUCTION AVAILABILITY					62.5%	

14.7 Comparisons

Following is a comparison of ground versus tower mount friction hoists.

Ground Mount Friction Hoist

Listed below are ground mount friction hoist advantages.

- Shorter headframe.
- Steel headframe (concrete is preferred in tower mounts for rigidity – reinforced concrete is not subject to residual stresses).
- An elevator is not required in the headframe.
- An overhead bridge crane may not be required.
- Easier access for maintenance.
- A heated headframe is not required.
- A water supply to the top of the headframe is not required.
- Shorter runs of power cables.
- Less susceptible to damage from overwinds, mine explosions, lightning, and earthquakes.
- The longer rope between the hoist and the highest point of conveyance travel makes rope surge and possible subsequent structural upset less likely.
- Most efficient use of available space in the shaft for conveyances.
- Generally believed to be less susceptible to operating problems. This may be partly due to the fact that it is more forgiving with respect to differential in hoist drum groove diameter because of the greater distance between the high point of travel for the conveyance and the hoist wheel.

Tower Mount Friction Hoist

Listed below are tower mount friction hoist advantages.

- Zero or one deflection sheave is required. Two are required for a ground mount – one is subject to reverse bending of the hoist ropes.
- Installing and changing head ropes is less complicated.
- Less real estate is occupied.
- The hoist ropes are not subject to the elements – icing is less of a concern.
- Rope vibration (whip) is less of a concern.
- The headframe tower may be more aesthetically pleasing.
- The headframe shell can be used for shaft sinking simultaneous with Koepe hoist installation above the sinking sheave deck.

15.0 Wire Ropes, Sheaves, and Conveyances

15.1 Introduction

This section is concerned with ropes, sheaves, and conveyances associated with mine hoists (discussed in the two previous chapters).

Wire ropes are fundamental to hoisting practice and, therefore, of great importance. What is not so evident is the role that ropes play in designing and selecting mine hoists. Hoist selection depends on having the ropes determined in advance. For a drum hoist, the ropes dictate the drum diameter, drum width, rope pull, and hoist inertia. For a friction hoist, the ropes dictate the wheel diameter, tread spacing, tread pressure, and wheel inertia.

Most non-mining people have a notion that breaking ropes is a constant danger. They feel more comfortable with a friction hoist because it has more than one rope (like an elevator). The fact is that a single rope in mine service very rarely breaks due to static overload. One reason is that when a rope is extended a great distance, it stretches elastically (not unlike a bungee cord). This yo-yo effect is the cause of a number of problems, none of which are normally life threatening. Unfortunately, non-mining people (politicians and bureaucrats) arbitrarily assign the SFs that govern rope selection. The result is that statutory SFs determining the use of ropes employed in mines are different from one place in the world to another. Because mine hoists are so dependent upon the ropes, a hoist that provides a certain production capacity at one location cannot be counted upon to provide the same service at a second mine elsewhere.

Standardization is impossible; therefore, all new hoists are custom-built for their application and second-hand hoists usually require extensive modifications before being employed at a new location.

Lack of standardization applies also to conveyances. Every mineshaft seems to have a different sized cage compartment and a mine-specific payload requirement; therefore, nearly every new cage is designed from scratch. Some standardization of skip compartment sizes exists based on the space provided in the old 6-foot by 6-foot rectangular timber shaft compartment, but even this convention is often forgotten when a new shaft is designed. The predictable result is that shaft conveyances are very expensive and the delivery time is long.

Sheaves are an exception to the lack of standardization problem. Satisfactory head sheaves for a new application can usually be built to off-the-shelf designs and suitable used sheaves are often obtained from the after-market without requiring modifications.

Recently, some important advances have occurred in wire rope design. One example is replacement of the old plastic core with a super plastic (such as Kevlar) applied beyond the core and into the strands resulting in a much stronger rope.

15.2 Rules of Thumb

Ropes

- The actual rope stretch when a skip is loaded at the pocket is almost exactly double that calculated by statics (PL/AE) due to dynamic effect. *Source:* L. O. Cooper

- The rope installed on a drum hoist or winch should be pre-tensioned to 50% of the working load. *Source:* George Delorme

- The tension required for a guide rope is one metric tonne (9.81 kN) for each 100m of suspended rope. *Source:* Tréfilunion

- The tension for a guide rope should be a minimum of 10 kN for each 100m of suspended rope. It is recommended to increase the tension further – up to the limit as set for the required SF of the rope. *Source:* Sigurd Grimestad

- The size of guide rope (steel area of cross section in mm², S) required is equal to 1½ times the length of suspended rope in metres, H. (i.e. S = 1.5 H). *Source:* Tréfilunion

- The pitch radius of a wire rope thimble should not be less than 3.5 times the rope diameter. *Source:* Largo Albert

- The length of a wire rope thimble should not be less than five times the pitch radius. *Source:* Largo Albert

Sheaves

- A change in direction of a rope (around a sheave) of 15° or more is generally accepted as constituting a complete bend. At lesser deflections, a grooved sheave should never be less diameter than one lay length (about seven times rope diameter), nor 1½ times lay length for a flat roller. *Source: African Wire Ropes Limited*
- For every increase in speed of 1 m/s (200 fpm), 5% should be added to the sheave or roller diameter. *Source: African Wire Ropes Limited*

Conveyances

- Conventional practice at hard rock mines is to employ “Kimberly” skips for a payload capacity of up to 5 tonnes and “bottom dump” skips for a payload between 5 tonnes and 20 tonnes. “Arc-door” skips are usually employed for payloads over 20 tonnes. *Source: Jack de la Vergne*
 - Aluminum alloy is as strong as mild steel and is three times lighter but six times more expensive. *Source: George Wojtaszek*
 - The centre of gravity of a loaded bottom dump skip should coincide with the geo-centre of the skip bridle. *Source: Coal Gold and Base Metals of South Africa*
 - The old rule stating that the bridle of a bottom dump skip should have a length equal to twice the set spacing has been demonstrated to be incorrect. *Source: Coal Gold and Base Metals of South Africa*
 - For a fixed guidance system, the bail (bridle) of a bottom dump skip or the length of an integral skip (between guide shoes) should be of minimum length equal to 1½ times the set spacing. For shaft sinking on fixed guides, the crosshead must be of minimum length equal to 1½ times the face-to-face distance between the guides, otherwise it will chatter. On rope guides, the length of the conveyance is of no concern. *Source: Jim Redpath*
 - A properly designed liner system should allow a skip to hoist 30,000 trips before the conveyance is removed from service for maintenance. *Source: Largo Albert*
 - A properly designed liner system should allow a skip to hoist 500,000 short tons before the conveyance is removed from service for maintenance. *Source: Largo Albert*
 - The regular maintenance refit and repair of an aluminum skip costs approximately 35% of the price of a new skip. *Source: Richard Mclvor*
 - A properly designed and maintained aluminum skip should have a total life of 5,000,000 tons (including refits and repairs). *Source: Richard Mclvor*
 - The cage capacity will be between 1.6 to 1.8 times the empty cage weight. *Source: Wabi Iron Works*
-

15.3 Tricks of the Trade

- The mass (unit weight) and strength of a hoist rope may be determined without benefit of a rope catalog (as follows).
 - Mass: If the diameter of the rope is d .. mm, then mass $m = k(d/10)^2$.. kg/m.
Where $k = 0.40$ for ‘flattened strand’ ropes, and $k = 0.55$ for ‘lock coil’ ropes
Example: For a flattened strand rope of 38mm, mass = 5.8 kg/m.
 - Strength: If the diameter of the rope is d .. mm, then strength $S = K(d/10)^2$.. kN.
Where $K = 70$ for ‘flattened strand’ ropes, and $K = 85$ for ‘lock coil’ ropes
The values of K are for steel of breaking strength 1770 MPa.
The value of K for steels of other strengths can be found by proportion.
Examples: For a flattened strand rope of 38mm & 1770 MPa, strength $S = 1011$ kN.
For a flattened strand rope of 38mm & 2000 MPa, strength $S = 1142$ kN.

Sources: Mike Gray and N. Brook

- When cutting a sample length (usually 8 feet) from a stranded hoist rope for statutory testing, it is often not practical to seize the rope ends with wire. Instead, the rope ends may be secured before cutting with punch-lock clamps placed side by side and in sufficient number to duplicate to length of the original wire seizing. *Source: George Delorme*

- A friction hoist counterweight conveyance should be designed to facilitate removal of weights with a forklift at the collar elevation. *Source:* Largo Albert
- New ropes installed on a winch or tugger hoist should be installed with no gap between rope coils on the first layer in order to provide better support for the next layer. *Source:* George Delorme
- When a stranded hoist rope goes slack, pigtails will form in the rope. A piece of 6-inch by 6-inch wood or piece of shaft timber inserted in a pigtail allows the rope to be drawn taught without fear of a permanent kink. *Source:* Bob Dengler
- A tail rope on a friction hoist frequently suffers a kink caused by ropes fouling each other or muck spilled from the loading pocket. The kink may be removed simply by drawing the rope through a post-forming tool four or five times. The tool consists of a bracket with a series of offset rollers that may be purchased from a hoist rope manufacturer. *Source:* Largo Albert
- Excess rope dressing on lock coil ropes is conveniently removed with neat Portland cement (powder). *Source:* George Delorme
- The outer layer of a lock coil rope consists of a number of “Z” shaped wires. They are interlocked to form a sealed outer cover so that lubricant cannot exude and water cannot enter. Occasionally, a wire will break and pop out of the cover. If this wire snags an obstruction, it can untwist to such a degree that it will damage the rope, requiring a complete replacement. As soon as a broken wire is discovered, it should be repaired by annealing and tapering so that the wires can be braised together and driven back into the rope to take its former position. This repair should last the life of the rope. *Source:* Largo Albert
- It has been found that when lock coil head ropes are disconnected, healthy ropes will spin out 1½ to two turns after each month’s operation; three or more turns generally indicates the onset of corrosion in the outer cover and means ropes should be dressed at more frequent intervals. Prior to reconnecting the ropes, it was considered good practice to tighten the outer wires by turning up to three turns to restrict entry of moisture and loss of internal lubricant. Because this action tends to loosen the inner wires (opposite lay), this practice is no longer recommended. A rope should be “dead” when connected. *Source:* Largo Albert
- In deep shafts, a stranded hoist rope will bunch up the rope lay at the bottom end while increasing the lay length at the top end. The torque build-up from this phenomenon can cause problems unless the rope is disconnected once a month or so and allowed to spin out twenty or more turns. *Source:* George Delorme
- Helicopter tires make good guide rollers. *Source:* Jim Robinson
- One problem with non-rotating ropes is that they have a constant lay length in operation. This means they get nicked at the same places with every cycle of the hoist. The nicked spots are quite visible on the rope string as it moves up and down the shaft. Non-rotating ropes were recommended as production ropes for very deep shafts in the RSA a few years ago, but this is no longer the case. *Source:* Bennett McLaughlin
- The non-rotating characteristic of stranded rope is derived from constructing the rope so that the inner strands are of opposite lay to the outer ones. The result is wear due to abrasion at the contact of crossed inner and outer strands when the rope is bent round a sheave or drum. *Source:* Richard Mclvor
- The construction of Lang lay ropes makes them better adapted to resist abrasion than regular lay ropes. *Source:* Robert E. Goodwin
- A significant portion of the height of a headframe is accounted for by the overwind distance that is required for the skips. This distance may be shortened in a practical manner by installing a “spot pneumatic discharge” instead of regular dump scrolls. *Source:* Len Deverell
- Ore skips may be used to lower material (such as road dressing or concrete aggregate) in the shaft to a dump pocket above the mining horizon. To clear the travel path required for ore hoisting, dump scrolls must be avoided. This may be accomplished by employing “guillotine-door” skips or a “spot pneumatic discharge” at the dump pocket. *Source:* Morris Medd
- In deep shafts, it is practical to eliminate the loading pocket and load the skips directly by conveyor. The batch function of the loading flask is replaced by a skip load of ore on the conveyor determined by a belt scale (weightometer). The slight increase in loading time is offset by a reduction in oscillation (bouncing skip), thus the total cycle time is maintained and the dynamic rope load is eased. *Source:* Jack de la Vergne
- Replacement of the steel liners at the back of the skip with 6-inch thick rubber liners has enabled skips to obtain a service life of up to one million tons before being changed-out for maintenance. *Source:* Largo Albert
- The specifications for a new cage should include provision of a trap door in the bottom deck. This will enable a cage tender to monitor a load slung beneath the cage as it travels through the shaft. *Source:* Largo Albert

- When faced with the lift of a heavy, long object that is relatively close (25-35 feet) to the “center-pin” of the crane, the crane should be roped with non-rotating cable (non-spin wire rope). The rated lift capacity of the crane should be a minimum of double the weight of the heaviest lift. A typical application is installing a casing (liner) in a newly bored ventilation raise where the liner sections will usually be five to ten feet in diameter and thirty to fifty feet in length. *Source:* Al Walsh

More tricks of the trade that relate to wire ropes, sheaves, and attachments are provided on a regular basis by a newsletter on the Internet. A free subscription may be obtained by contacting the publisher (georgedelorme@sympatico.ca).

15.4 Characteristics of Wire Ropes

The first wire ropes were constructed of drawn wire (like piano wire) that was braided together like ordinary fiber ropes. Individual wires were wound into strands and the strands were braided around a straight core. The strands in the rope were first put together with the wires and strands wound in the opposite direction (regular lay). It later discovered if they were wound in the same direction (Langs Lay), the rope would be more flexible and enjoy greater resistance to fatigue (although less resistant to kinking and untwisting).

These simple ropes became known as “round strand” ropes and were popular for mine hoists because they allowed for inspection for internal corrosion and broken wires. With the introduction of electro-magnetic non-destructive testing, this characteristic was no longer necessary. As a result of this technical advance, round strand ropes were replaced with ropes made from triangular (flattened) and oval wires. These “flattened strand” ropes were stronger and more wear resistant.

The core of stranded ropes once always consisted of fiber (sisal). Today, they are most often supplied with a plastic core. It is believed that the plastic core provides important structural support for the rope strands and hence reduces internal abrasion (wear). On the other hand, it has been proposed that fiber core should be specified mainly because the plastic core is believed unable to provide good lubrication to the rope's inner strands. This opinion is supported by the U.S. Corps of Engineers who report that the contact zone between steel strands and plastic provides opportunity for minute “corrosion cells” to develop. Another expert apparently resolves the dilemma when he states that fiber core should be employed in a wet shaft to fight corrosion, while a plastic core is the better choice for a relatively dry shaft.

The other type of rope employed in the mining industry is known as “lock coil.” The basic rope consists of a stranded rope core covered with a ring of alternating round and indented wires and is known as a half-lock coil rope. These ropes are employed mainly as guide and rubbing ropes. A full-lock coil rope consists of a half-lock coil rope covered with a concentric ring of Z shaped wires. Because these ropes are weaker in relation to their weight, they were not often used at hard rock mines except in North America where they were and are employed as headropes for friction hoists. Today, these ropes are more popular, especially for shaft sinking, because of their non-rotating characteristic and the fact that they are now manufactured with a high breaking strength despite the relatively large size of the wires they contain.

15.5 Diameter of Wire Ropes

Confusion sometimes exists in the mining industry with respect to rope diameter. It is well understood that rope diameter is measured as the largest reading on the rope circumference – the confusing part is the true meaning when a rope diameter is specified. For example, a rope manufacturer may build a rope that is slightly smaller than the nominal diameter when he knows it is to be fitted to a hoist with tight grooving on the drums. The rope provided still meets the strength criteria because manufacturers commonly build a “cushion” from 5-10% in the breaking strength published in their catalogues. Nobody notices the slight discrepancy and the rope remains identified by the diameter specified in the purchase order. Another problem occurs when the slack end of a rope is measured to determine its diameter; often the reading will be higher than the true diameter. To help overcome the confusion, it is helpful to provide definitions when reporting on rope diameters. The following definitions are accepted in South Africa and suggested for application elsewhere.

- *Actual Rope Diameter* – diameter of the rope when new and under a tensile load of 10% of the nominal rope strength.
- *Nominal Rope Diameter* – rope diameter as specified by the manufacturer.

15.6 Safety Factors for Wire Ropes

It is obvious that to maintain a maximum degree of safety, certain restrictions must be placed on the loads carried by hoisting ropes. The three significant stresses on a hoist rope are static, dynamic, and bending stresses.

The maximum static stress is the largest and is simply due to the maximum dead weight load on the rope. The dynamic stress is caused by the force due to acceleration that produces a maximum value of less than half the static stress. This is because the maximum acceleration/retard is less than ½ g, even with the severest braking effort. The bending stress is approximately equal to the modulus of elasticity of the rope divided by the ratio of bending diameter to the diameter of an individual wire in the rope. This typically amounts to a maximum of 5% of the static load.

The *statutory* factors of safety take only the static loading into account and do not directly address forces due to acceleration and bending. As stated in the introduction, the statutory factors of safety vary from one jurisdiction to another. In most cases, the rules provide for a lesser factor as the hoisting distance increases. For example, the MSHA (USA) regulations stipulate a factor of $7-0.001L$ to a minimum of 4 in which L is the hoisting distance measured in feet. In the Canadian provinces, the allowance for depth is accounted by the application of two SFs: one “at the head sheave” (capacity factor) and a second one (SF of 5) at the conveyance that takes the weight of the rope into account.

Several years ago, the statutory factor of safety was reduced significantly in the Republic of South Africa to $25,000/(4,000+L)$ in which L is the hoisting distance measured in meters. The new statute is the result of extensive study by a committee of experts. It should be noted that other factors (dynamic and bending) that have an effect on rope stress are required to meet specified rules, as are other factors that relate to good hoisting practice, all of which are strictly enforced.

The reduction is significant in very deep shafts and is being studied in other countries that mine deep. In fact, it is already employed in the Province of Quebec, Canada for production (skip) hoisting.

15.7 Selection of Wire Ropes

Since ropes are the major item of total cost and their selection the most difficult, specific criterion for selecting hoist ropes follows.

The lowest total cost of the hoisting ropes is directly proportional to the rope life. The maximum theoretical rope life is typically based upon the estimated fatigue strength of the ropes; however, the rope life will be shorter than the fatigue life (maximum life) if discard criteria are met as a result of one of the following situations.

- Corrosion
- Wear (abrasion and nicking)
- Plastic deformation (peening)
- Accidental damage (kink, burn, etc.)
- Pernicious damage (poorly designed riser, sheave tread, etc.)
- Structural upset (birdcage, spinout, etc.)
- Martensitic alteration (slap)
- Galvanic action

The classical failure mechanism was fatigue, and it still is in some cases, but not for stranded ropes on drum hoists, which is the most common application. Production (skip) hoist ropes are the major consideration because they are normally the largest ropes and do by far the most work when in operation. For these installations, rope life is most often determined by wear; therefore, the major criterion for the selection of the skip hoist ropes should be avoidance of *wear*.

“In reviewing the circumstances that led to the removal of ropes in recent times, I have now come to the conclusion that, especially for production hoisting, we should use galvanized ropes and forget about trying to protect the ropes’ interior. The galvanization will take care of this! We should then concentrate solely on the outside and protect the ropes against wear.”

George Delorme

Galvanized ropes are gradually becoming standard practice in the industry. Today, it is often recommended that new ropes be ordered galvanized. The extra cost for galvanizing is about 10%.

15.8 Selecting Rope Attachments

Several types of rope attachments are commonly employed in the industry.

- Thimble and clips
- Wire rope socket (spelter socket)
- Cappel (wedge cappel)
- Wedge thimble (thimble cappel)

The *thimble and clip* attachment is the most popular and may be employed for any size of rope, but is usually applied to smaller diameter ropes. Properly installed and maintained, the thimble and clip is a safe and reliable attachment. In the past, failures have occurred (dropped skip) that were later attributed to rope pinch from over-torquing of the clips, particularly the first clip. Today, the rope clip manufacturers have revised their instructions to overcome this condition. The disadvantage of this type of attachment with larger rope diameters is the large number of clips required and the increased spacing that results in some problems with daily inspection, overwind, and wasted rope (with each end cut).

The *wire rope socket* consists of a resin compound poured into and around the end of a wire rope inside a steel socket. The rope end is seized, broomed (splayed), and cleaned (each wire) before pouring the resin. The wire rope socket attachment is popular with shaft sinkers (who employ non-spin ropes) but is rarely employed for mine operations using stranded ropes. One reason is the potential hazard of the rope spinning out at no load condition. The following excerpt corroborates this concern.

"Sockets may fail from lack of grip of the wires to the compound, crumbling failure of the resin compound, or from (bending) fatigue (or internal corrosion) at the narrow end (neck). Wedges and thimbles with rope clips give indication of an overload by rope slip within the attachment. There is no such warning with a socket – failure is sudden."

OHSA, Mines Branch, Information Sheet No. R. S. 221

The *cappel* is popular for friction hoists and is also employed for larger drum hoist ropes at some mines. The reason most often given is that the cappel facilitates routine daily inspection. Its construction is such that when properly installed, it is probably the most reliable type of attachment; however, installation can be a problem due to the complicated procedure.

The *wedge thimble* is the most widely used rope attachment for larger hoist ropes. It is the simplest to install and does not require a specialist who may not be readily available when needed. Additionally, daily inspections are simple to perform on the wedge thimble.

One disadvantage is the weight of the wedge thimble. Another potential drawback to the use of this attachment is that it is reported that the wedge thimble does not develop 100% of the breaking strength of the rope (as does the rope socket or wedge cappel) (SME Handbook, page 1671 and WRI General Information Catalogue, page 46). It is believed that this information is based on an obsolete type of wedge thimble that did not incorporate a rope clip (block) on the rope end.

15.9 Minimum Drum and Sheave Diameters

For many years, it was thought that the drum (or sheave) to rope diameter ratio was a significant factor in determining rope life. Research carried out independently in South Africa and the USA has shown this hypothesis to be false. A report from the Battelle Institute at Columbus, OH summed it up as follows: "Bending fatigue is not the most dominant factor in rope degradation. Apparently, a corrosion-assisted fatigue process or corrosion itself is more influential on rope failure." As a result, the statutes relating to drum (and sheave) to rope diameter ratio were struck from MSHA regulations; however, the regulations relating to this ratio remain in effect in the Canadian provinces and elsewhere. In particular, the new regulations in South Africa specify that the ratio shall not be less than $40 + 4V$, where V is the rope speed in m/s, but does not have to exceed 140.

For mine hoists and sheaves, the minimum ratio is normally best determined by consultation with the selected rope manufacturer.

A concern still exists about the minimum sheave to rope diameter ratios for slow hoisting with stage hoists used for shaft sinking. These are not accounted for in mine regulations. Table 15-1 may be used as a guideline for hoisting speeds less than 1m/s (200 fpm).

Table 15-1 Hoisting Speeds Less than 1m/s

Rope Construction	Minimum Sheave Diameter
6 by 19 FS	26 x rope diameter
6 by 25 FS	23 x rope diameter
6 by 36 FS	20 x rope diameter
6 by 37 FS	19 x rope diameter
7 by 18 NR	30 x rope diameter
7 by 27 NR	28 x rope diameter
Fishback NR	28 x rope diameter
7 by 34 NR	26 x rope diameter
Lock Coil to 1-inch diameter	40 x rope diameter
Lock Coil to 1½-inch diameter	50 x rope diameter
Lock Coil to 2-inch diameter	60 x rope diameter

15.10 Typical Skip Factors for Mine Hoists

Skip factor is the ratio of the tare (empty) weight of a skip to the payload. An assumption of the skip factor is needed to determine the hoist rope(s) required. The values in Table 15-2 are for typical conditions and should be slightly modified for unusual situations (see notes that follow the table).

Table 15-2 Skip Factors

Skip Capacity	Steel Skip	Aluminum Skip
4 tons	0.90	0.54
6 tons	0.85	0.53
8 tons	0.78	0.49
10 tons	0.75	0.48
12 tons	0.74	0.48
14 tons	0.73	0.48
16 tons	0.72	0.47
18 tons	0.71	0.47
20 tons	0.70	0.46

Notes

- These factors are for standard skip compartments: 6 feet by 6 feet.
- These factors are for standard Lakeshore® bottom dump skips.
- These factors are for skips with steel liners.
- These factors are for an ore with an SG =2.67 (bulk density of broken ore approximately 100 Lbs./cubic foot = 20 cubic feet per short ton = 1.67 tonnes/m³).
- Adjust these figures slightly downwards for sulfide ore (heavy), rubber liners or “throw away” skips.
- Adjust these figures slightly upwards for skips equipped with safety dogs.
- These factors are not to be used for friction hoists that hoist two skips in balance from depths less than 4,000 feet (1,200m) without investigating the requirement for the skips to be ballasted with extra weight to maintain a safe tension ratio.

15.11 Clearances and Rub Rope Requirements for Rope Guided Hoisting Shafts

The following minimum spacing should be maintained in installations where rope guides are used.

- 300mm between a conveyance or counterweight and the shaft wall or shaft installations, except in areas of fixed guides at the ends of the travel range.
- 500mm between the conveyances or between conveyances and counterweights. This spacing can be reduced to 300mm if rubbing ropes are employed.

Source: George Delorme

These guidelines reflect North American practice. In Sweden, the guidelines are similar, except that in the first instance, 250mm is allowed between a conveyance and a lined (smooth) shaft wall, otherwise 400mm is required. (For shaft sinking clearances, refer to Chapter 10 – Shaft Sinking.)

15.12 Rope Stretch for Skip Hoist Ropes

The hoist rope will stretch at a station when the cage is loaded and even more at the loading pocket due to the dynamics of the ore falling and impacting on the suspended skip. To overcome this problem, chairs may be employed to hold the cage or skip in place while being loaded. Chairs are not normally required for friction hoists; however, they may be necessary for drum hoist installations in deep shafts.

Example

Calculate the rope stretch for the following case.

- Facts:
1. Skip payload = 18 short tons
 2. Collar to LP = 4,684 feet
 3. Collar to dump = 60 feet
 4. Sheave to dump = 33 feet
 5. Rope diameter = 2.25 in.
 6. Rope Construction = Flattened (triangular) strand

Solution: The static stretch, $\Delta_S = \frac{P \cdot L}{A \cdot E}$

P = Payload = 18 short tons = 36,000 Lbs.

L = Suspended Rope = 4,684 + 60 + 33 = 4,777 feet

A = Rope cross sectional area = 3.98 in.²

E = Modulus of elasticity of the rope = 10,000,000 Lbs./in.² (selected from the following tabulation)

E = Modulus of elasticity = 8,000,000 Lbs./in.² (round strand rope)

E = Modulus of elasticity = 9,000,000 Lbs./in.² (shaft sinking rope)

E = Modulus of elasticity = 10,000,000 Lbs./in.² (flattened/triangular strand rope)

E = Modulus of elasticity = 14,00,000 Lbs./in.² (lock coil rope)

E = Modulus of elasticity = 16,00,000 Lbs./in.² (½ lock coil rope)

$$\therefore \Delta_S = 36,000 \cdot 4,777 / 3.98 \cdot 10,000,000 = 4.3 \text{ feet}$$

The total (dynamic) rope stretch, $\Delta_d = 2 \times \Delta_S = 8.6 \text{ feet}$

16.0 Headframes and Bins

16.1 Introduction

Chapter 16 deals with headframes for mine hoists. Headframes are built with timber, steel, concrete, and a combination of steel and concrete. Wood headframes are no longer built in industrialized countries, but they still have application in the developing world. The question as to whether a steel or concrete headframe will be best for a particular project is a problem often encountered; therefore, this chapter examines this dilemma in detail.

The height of a headframe, for purposes of engineering, is defined as the vertical distance from the collar elevation to the center-line of the highest head sheave when ground mounted hoists are employed. For tower mounts, it is the distance from collar to the centerline of the highest hoist wheel or drum.

As a general rule, steel headframes are employed for drum hoists and ground mounted friction hoists while concrete headframes are employed for tower mounted friction hoists, sometimes including small drum hoists mounted in the same tower.

No standard designs exist for steel or concrete headframes – each one is custom built.

16.2 Rules of Thumb

Wood Headframe

- The maximum height of a wood headframe is 110 feet. The maximum rope size for a wood headframe is 1.25 inches diameter, which corresponds to an 8-foot or 100-inch diameter double-drum hoist. *Source:* Jack de la Vergne

Steel Headframe

- A headframe (for a ground mounted hoist) should be designed with the backlegs at an angle of 60 degrees from the horizontal and the rope flight from the hoist at an angle of 45 degrees. *Source:* Mine Plant Design, Staley, 1949
- It is better to design a headframe (for a ground mounted hoist) such that the resultant of forces from the overwound rope falls about 1/3 the distance from the backleg to the backpost. *Source:* Mine Plant Design, Staley, 1949
- No members in a steel headframe should have a thickness less than 5/16 of an inch. Main members should have a slenderness ratio (l/r) of not more than 120; secondary members not more than 200. *Source:* Mine Plant Design, Staley, 1949
- Main members of a modern steel headframe may have a slenderness ratio as high as 160 meeting relevant design codes and modern design practice. *Source:* Steve Boyd
- The cost of a steel headframe increases exponentially with its height while the cost of a concrete headframe is nearly a direct function of its height. As a result, a steel headframe is less expensive than a concrete headframe, when the height of the headframe is less than approximately 160 feet (at typical market costs for structural steel and ready-mix concrete). *Source:* Jack de la Vergne
- At the hoist deck level of a tower mount headframe for Koepe hoisting, the maximum permissible lateral deflection (due to wind sway, foundation settlement, etc.) is 3 inches. (This may favor a concrete headframe.) *Source:* R. L. Puryear
- A concrete headframe will weigh up to ten times as much as the equivalent steel headframe. (This may favor the steel headframe when foundations are in overburden or the minesite is in a seismic zone.) *Source:* Steve Boyd

Headframe Bins

- To determine the live load of a surface bin for a hard rock mine, the angle of repose may be assumed at 35 degrees from the horizontal (top of bin) and the angle of drawdown assumed at 60 degrees. *Source:* Al Fernie
-

Headframe Bins (continued)

- A bin for a hard rock mine will likely experience rat-holing (as opposed to mass flow) if the ore is damp, unless the dead bed at the bin bottom is covered or replaced with a smooth steel surface at an angle of approximately 60 degrees from the horizontal. *Source:* Jennike and Johanson
 - The live-load capacity of the headframe ore bin at a small mine (where trucking of the ore is employed) may be designed equal to a day's production. For a mine of medium size, it can be as little as one-third of a day's production. For a high capacity skipping operation, the headframe should have a conveyor load-out, either direct to the mill or elevated to separate load-out bins remote from the headframe. A conveyor load-out requires a small surge bin at the headframe of live load capacity approximately equal to the payload of 20 skips. *Various Sources*
-

16.3 Tricks of the Trade

- For Koepe (friction) hoist installations of modest capacity and shaft depth, a steel headframe tower can be less expensive than concrete. Major installations usually employ a concrete tower, but each project is unique and should be considered on its own merits. *Source:* V. B. (Jim) Cook
- A steel headframe that is custom-designed to provide a high clearance at the collar entry requires a rigid frame design for the large opening. This is only accomplished with an increase in design hours as well as increasing the weight (and hence the fabrication cost) of a steel headframe. *Source:* Bill Reid
- A steel headframe with backlegs built from a pipe section is aesthetically pleasing and simple to fabricate, but the top connection is a significant problem that requires an in-depth structural analysis and great difficulty in fabrication. *Source:* Laddie Malkiewicz
- A steel headframe with backlegs built to the shape of a box girder in the style that is popular in Germany is aesthetically superior, but when built to North American structural design codes, it becomes an expensive alternative. *Source:* Laddie Malkiewicz
- For a steel headframe less than 100 feet in height, it may be economical to build the backlegs from a wide flange or girder sections. A higher headframe is most economically served with backlegs built to a truss design. *Source:* Steve Boyd.
- When selecting a friction hoist for a tower mount in a steel headframe, it is important to have an over-hung direct drive for the hoist. In this way, the hoist is suspended at two points rather than three. *Source:* Gerald Tiley
- It is a practical certainty that the cladding on a steel headframe will sustain local damage at some time during the life of the mine – and cladding can be difficult to match several years down the road. When purchasing the cladding, be sure to order some extra for dedicated inventory. *Source:* Eric Seraphim
- Most mines employ the doubling down method to install and replace wire ropes on a drum hoist. The procedure places an extremely heavy load on the banking beam above the dump in the headframe. Before fabrication, it should be verified that the headframe incorporates a banking beam designed to take the anticipated loading. In addition, it is convenient if the headframe design incorporates a chair near the collar elevation to bank the conveyance. *Source:* Bennett McLaughlan
- A concrete headframe is better designed with a widened corridor on the load-out side to facilitate skip removal. *Source:* Leo Roininen
- A concrete headframe designed to a circular rather than rectangular cross-section will save on concrete quantity and reduce the wind load by 35%. *Source:* Harry Braun
- The aesthetics of a concrete headframe are improved with the provision of vertical flutes in the concrete. It is a simple matter to incorporate flutes into the slip forms, but the price paid is extra concrete equal in thickness to the depth of the flute. *Source:* Harry Braun
- A new concrete headframe should be designed to include plastic pipe inserts in the poured concrete to facilitate the use of explosives for ultimate demolition when the minesite is eventually reclaimed. *Source:* Peter R. Jones
- Underground headframes are often best served by friction hoists, the components of which are smaller and easier to transport underground. *Source:* Jack de la Vergne
- Where an underground headframe is to be lined with concrete and must be enlarged in cross-section from a circular concrete shaft, the simplest means for construction is to put a dutchman in the shaft forms to increase the diameter and use these forms to build the headframe. *Source:* Chris Hickey

- The height of a headframe designed for skip hoisting is often later found too short for shaft sinking, where it is planned to dump shaft muck from sinking buckets into the permanent bin. *Source:* Jim Tucker
- The sheaves on a headframe designed for ground mounted drum hoists should be oriented such that the rope flights aim at the center of the drum face. *Source:* Largo Albert
- Where the flight of rope between the hoist and headframe is of such a length and trajectory that intermediate idler sheaves are necessary to support the hoist rope, the suspended distances of hoist rope should be made unequal to dampen the effects of vibration (rope whip). *Source:* William Staley
- Anyone involved with the installation of a friction hoist in a headframe tower would be wise to consider the early installation of the headframe passenger elevator of paramount importance. *Source:* Roy Lonsdale

16.4 Steel Headframe versus Concrete Headframe

Following are the advantages of a steel headframe.

- A steel headframe is normally less expensive than a concrete headframe, unless its height exceeds 50m.
- A steel headframe is more adaptable to modifications.
- A steel headframe is considerably lighter and, therefore, requires less substantial foundations.
- A steel headframe is simpler to design (and design errors are less likely) using off-the-shelf design programs.
- Construction errors and blunders are more readily remedied on a steel headframe than on a concrete headframe.
- A steel headframe is more readily adapted to design against high seismic loads in earthquake zones.
- Steel erection is convenient to interrupt for statutory holidays or stormy weather while slip forming of concrete is not.
- Quality assurance is simpler with a steel headframe whose components were milled and fabricated under “shop conditions” as opposed to a concrete headframe where quality control is more concerned with “field conditions.”
- A steel headframe is simpler to re-plumb if differential settlement occurs at the foundations, particularly if the backleg base connections are designed to be adjustable (as is the case for frozen shafts).
- At mine closure, a steel headframe is simpler to demolish and its components may have scrap value.

Following are the advantages of a concrete headframe.

- A concrete headframe requires less maintenance and is less susceptible to corrosion.
- Little ready-mix concrete is wasted during construction of a concrete headframe as opposed to a steel headframe, where there is waste of steel from (1) scrap ends during fabrication, and (2) upgrading the size of substituted members sizes not immediately available at the time of fabrication.
- Reinforced concrete is not subject to residual stresses from manufacture or fabrication.
- A concrete headframe provides an enclosure upon construction while a steel headframe requires insulated cladding to be weather tight.
- A concrete headframe provides better opportunity for architectural aesthetics in the opinion of most designers.
- A concrete headframe is less susceptible to vibration.
- A concrete headframe is less susceptible to sway during high winds.
- Except for remote locations, ready mix concrete and rebar is almost always readily available on short notice at a predictable cost. Structural steel is sometimes in short supply and the price of fabricated steel is volatile.
- A concrete headframe designed to accommodate a ground-mounted hoist is most often designed without backlegs, saving desirable real estate.
- A concrete headframe is less susceptible to damage from run-away vehicles, wayward mobile crane booms, etc.

16.5 Weight of a Steel Headframe

The weight of a steel headframe must be known to estimate its cost. The weight is dependent primarily on the height. Height is discussed in Section 16.6.

The weight of a steel headframe can be estimated from the following formulae.

For a single production hoist ¹	$W_1 = 0.12H^3(D/100)^2$
For a single production hoist ²	$W_1 = 1.75H^{2.45}$
For a separate skip and service hoist ¹	$W_2 = 1.20 W_1$
For a separate skip and service hoist ²	$W_2 = 1.55 W_1$

Where W is in Lbs., H is the height of headframe in feet, and D is the drum diameter of the larger hoist in inches. Where the headframe is designed to support stage sheaves for sinking a circular concrete shaft, its weight may approach that required for a separate skip and cage hoist even though only one hoist is planned for the production phase.

Example

Estimate the weight of a steel headframe equipped with both one and two ground mounted double drum hoists.

- Facts:
1. The headframe is 128 feet high
 2. The headframe is first designed for a single ten-foot diameter double drum hoist
 3. The headframe is then designed with the addition of a cage hoist

Solution:

Single hoist

Weight = 181 tons by the first formula and 127 tons by the second formula

Two Hoists

Weight = 217 tons by the first formula and 197 tons by the second formula

Note

The wide variation in results obtained from the two formulae confirms that there is no simple means to accurately estimate the weight of a steel headframe in advance. In the absence of better information, it is suggested that the results of the two formulae be averaged to obtain an approximate value.

¹ O'Hara and Suboleski, *Costs and Cost Estimation*, SME Mining Engineering Handbook, Ed II.

² Jack de la Vergne

16.6 Height of a Steel Headframe

Since the weight of a steel headframe is directly related to the height, it is required to first estimate the height of the headframe, which in this case is defined by the distance from the collar to the centerline of the highest sheave.

The height may be calculated from the following published formulae.

$$\text{Headframe height}^3 = 0.25D + 5.5(D/100)^3 + 6.3T^{1/3}$$

$$\text{Headframe height}^4 = 8.0T^{0.3} + 1.2V^{1/2}$$

Where D = drum diameter (inches)

T = daily production (short tons)

V = hoist rope speed (fpm)

Example

Determine the headframe height in the following case.

- Facts:
1. Hoist drum diameter of 10 feet
 2. Production 3,000 short tpd
 3. Rope speed 2,400 fpm.

Solution: Headframe height = 128 feet by the first formula and 147 feet by the second one!

As can be seen in Table 16-1, the headframe height can vary significantly for a particular application depending on the degree of overwind clearance desired, bin capacity, etc. The variance provides good evidence that headframe height should be determined on a case-by-case basis (with due consideration to the exponential cost increase of a higher headframe). It also explains why the quick estimate of headframe weight performed in the previous section could not be accomplished with accuracy. The table that follows is provided to assist in a more accurate determination of headframe height for a proposed installation.

³ O'Hara, Allan, *Quick Guides to the Evaluation of Orebodies*, CIM Bulletin, February, 1980

⁴ O'Hara and Suboleski, *Costs and Cost Estimation*, SME Mining Engineering Handbook, Ed II.

Table 16-1 Height of Steel Headframe for a 10-foot (3m) Double Drum Production Hoist

General Description	Deluxe	Standard	Budget	Poor-Boy	Haywire
Overwind Calculation Load-out Facility (ore) Dump Side Load-out Vehicle	Maintenance Department 1,000 ton bin Front of HF Pit truck	Engineering Department 750 ton bin Front of HF Semi	Rule of Thumb 500 ton bin Under backlegs Dump truck	Rule of Thumb Dump on ground Front of HF FE Loader	Rule of Thumb Dump on ground Under backlegs LHD
Retaining wall height	-	-	-	20 feet- 0	17 feet- 0
Collar to bin distance	20 feet- 0	18 feet- 0	16 feet- 0	-	-
Ore bin	56 feet- 0	48 feet- 0	42 feet- 0	-	-
Dump chute	12 feet- 0	12 feet- 0	6 feet- 0	10 feet- 0	4 feet- 0
Length of 8-ton skip	27 feet- 0	27 feet- 0	27 feet- 0	27 feet- 0	27 feet- 0
Extra O/W to dump sinking bucket	-	2 feet- 0	4 feet- 0	3 feet- 0	3 feet- 0
Overwind distance	15 feet- 0	12 feet- 0	10 feet- 0	10 feet- 0	10 feet- 0
Allowance for track and Lilly limits	10 feet- 0	6 feet- 0	5 feet- 0	5 feet- 0	4 feet- 0
Sheave beam depth	3 feet- 6	3 feet- 6	3 feet- 6	3 feet- 6	3 feet- 6
Lower ½ pillow block	1 feet- 6	1 feet- 6	1 feet- 6	1 feet- 6	1 feet- 6
TOTAL HEIGHT HEADFRAME	145 feet	130 feet	115 feet	80 feet	70 feet

17.0 Conveyors and Feeders

17.1 Introduction

Although different types of conveyors find application in hard rock mines, this chapter discusses belt conveyors, which are by far the most common. Underground hard rock mines use belt conveyors for lateral and inclined ore transfer; however, belt conveyors are not as popular as they are for similar surface applications. Belt conveyors for underground service usually have a more rugged design and operate at slower speeds than a comparable overland conveyor.

Hard rock mine belt conveyors normally require the ore to be crushed before it is conveyed or at least broken enough to pass through a grizzly opening. Run-of-mine (ROM) material is not normally conveyed except for short level runs. The finer the ore is crushed, the longer the belt life, the more reliable the system, and the lower the operating cost. The reasons for this include less impact from lumps and the elimination of tramp material, such as rock bolts, rebar, drill steel, and scaling bars that can wreak havoc on a belt conveyor. The least cost and most reliable underground belt conveyor system ever installed is reputed to be the one at the Gaspé Copper Mine that employed both primary (jaw) and secondary (cone) crushers underground to size the conveyor feed.

Belt conveyors conserve energy because they are driven by electric motors with an efficiency of near 95% and their payload-to-dead load ratio is approximately 4:1. By comparison, the efficiency of the diesel engine in a haulage truck does not exceed 40% and a truck's payload-to-dead load ratio is no better than 1½:1.

Belt conveyor systems are less flexible than truck haulage and require a high initial investment. Usually, this means that belt conveyors are the economical choice only when there is a relatively high production rate and the transport distance is significant. Belt conveyor systems are selected for other reasons in certain applications (for example, short conveyors are employed underground to optimize control of feed to a loading pocket and prevent a run of fines from reaching the shaft).

Special types of belt conveyors include extendable systems, cable belts, and high angle (HAC) belts. The special conveyor types have had few applications in hard rock mines to date and are not dealt with in this chapter.

Many types of feeders exist for belt conveyors, but the most popular in hard rock mines is the vibrating feeder. The more expensive apron (caterpillar pan) feeder is still employed in certain applications, such as handling large lumps. In larger operations, the belt feeder has largely displaced the apron feeder. Other types of feeders are rarely employed in underground mines. Even Ross chain feeders have been used, but their normal application is for crushers and not conveyors.

Due to the fact that many existing computer programs predate metric usage, conveyor calculations are most often completed in imperial units of measure. This practice is followed in the text of this chapter.

17.2 Rules of Thumb

Costs

- An underground mine is more economically served by a belt conveyor than railcars or trucks when the daily mine production exceeds 5,000 tons. *Source: Al Fernie*

- As a rule, a belt conveyor operation is more economical than truck haulage if the conveying distance exceeds 1 kilometer (3,280 feet). *Source: Heinz Altoff*

- The ton-mile cost of transport by belt conveyor may be as low as one-tenth the cost by haul truck. *Source: Robert Schmidt*

- The installed capital cost of a long belt conveyor system to be put underground is approximately equal to the cost of driving the heading in which it is to be placed. *Source: Jack de la Vergne*

- Operating maintenance cost per year for a belt conveyor is 2% of the purchase cost of equipment plus 5% of the belt cost. To this should be added belt replacement every five to 15 years (five for underground hard rock mines). *Source: Hans Nauman*

Feed and Feeders

- In a hard rock mine, the product from a jaw crusher to feed a conveyor belt will have a size distribution such that the -80% fraction size is slightly less than the open side setting of the crusher. For example, if the open side setting of the underground jaw crusher is 6 inches, then the d_{80} product size = 5¼ inches. *Source: Unknown*

 - For an apron feeder, the bed depth of material fed should be uniform and equal to one-half the width of the feeder. *Source: Dave Assinck*
-

Feed and Feeders (continued)

- A vibratory feeder is best designed for a bed depth of about half its width. *Source:* Bill Potma
- The free fall of crushed ore to a belt must not exceed 4 feet. Chutes, baffles, or rock boxes should be employed to reduce impact and save belt life. *Source:* Heinz Schober
- The horsepower requirements for apron feeders listed by manufacturers are generally low. They should be increased by a factor of 30 to 50% to take into account considerations like starting torque, starting when cold, when the bearings are sticky, and when the bearings become worn. *Source:* Reisner and Rothe
- Power requirements for apron feeders are about twice as high as for comparable belt feeders. *Source:* Reisner and Rothe
- A well-designed jaw crusher installation has the lip of the chute overlapping the throat of the vibrating feeder by 400mm (16 inches) to prevent spill resulting from the inevitable blowback of wayward fines. *Source:* Jean Beliveau
- 75-90% of belt wear occurs at the loading points. *Source:* Lawrence Adler

Belt Conveyor Design

- On well-engineered systems, using appropriate controls to limit acceleration, the (static) factor of safety for belt tension can be reduced from 10:1 to 8:1 for fabric belts and from 7:1 to 6:1 for steel cord belts. *Source:* D. T. Price
- The standard troughing angles in North America are 20, 35, and 45 degrees. In Europe, they are 20, 30, and 40 degrees. A 20-degree troughing angle permits the use of the thickest belts, so the heaviest material and maximum lump size can be carried. A troughing angle of 35 degrees is typically employed for conveying crushed ore. *Source:* Unknown
- For conveying crushed ore, the cross-section of the material load on the belt can usually be accurately calculated using a 20-degree surcharge angle. It should be considered that when conveying over a long distance, the dynamic settling of the load could reduce the surcharge angle to 15 degrees. *Source:* Al Firnie
- Finely crushed or ground ore must be loaded on a flat section of the belt. A good rule of thumb is to leave a bare minimum of 8, and preferably 12, feet of horizontal belt before a vertical curve is even started. *Source:* Robert Shoemaker
- The availability of a belt conveyor is 90%; if coupled with a crusher, the availability of the system is 85%. *Source:* Wolfgang Guderley
- Stacker conveyors (portable or radial) should be inclined at 18 degrees (32%) from the horizontal. *Source:* Dave Assinck
- To prevent a run of fines from reaching the mineshaft, the minimum length of a conveyor to a loading pocket should be such that there is a slope of 15% between the load out chute and the lip of the station at the shaft. *Source:* Virgil Corpuz
- In-pit conveyors should not be inclined more than 16½ degrees (29%) from the horizontal. *Source:* John Marek
- A downhill conveyor should not be designed steeper than 20%. This is the maximum declination for containing material on the belt under braking conditions. *Source:* Al Firnie
- The pulley face should be at least 1 inch wider than the belt for belts up to 24 inches wide and 3 inches wider for belts greater than 24 inches. *Source:* Alex Vallance
- The length of skirt boards should be at least three times the width of the belt. *Source:* Jack de la Vergne

17.3 Tricks of the Trade

- The easy way to have your conveyor system designed for a particular application is to call your friendly local belt or idler sales agent and ask him to do it for you on his computer program. This service is usually performed promptly and without charge. The procedure will help ensure that you have put together all the information required and identify possible problem areas or items of potential controversy. You may talk the agent into giving you a copy of his program so that you can readily make adjustments in-house to accommodate changes resulting from subsequent detailed design. *Source:* Jack de la Vergne

- One way to have a computer program designed for overland conveyors work for an underground mine installation is to change the output as follows: raise the drive HP by 5%, increase the belt width by 6 inches, shorten the carrying idler spacing by six inches, and kick up the idlers by one class and one size. *Source:* Jack de la Vergne
- A continuous ore handling system (conveyor) is more easily automated than a batch system (rail cars or trucks). *Source:* Fred Edwards
- To increase the capacity of an operating belt conveyor, it is more practical and less expensive to install a linear drive conveyor booster than to replace the drive. *Source:* Dowty Meco
- When installing a long horizontal belt conveyor, it is normally specified to vulcanize all the splices. If one of them is made a mechanical splice, it will facilitate the belt cut required as a result of initial belt stretch in operation. *Source:* Gus Suchar
- Supporting columns for a belt conveyor system can be protected from wayward travel of mobile equipment by enclosing the bottom portion with a culvert section and filling it with concrete. *Source:* Dennis Sundborg
- Rollback on a belt conveyor may be prevented by chevron patterns on the belt, but avalanching of fine material can only be overcome by reducing the bed height of the material on the belt and, if necessary, increasing the flight speed to restore capacity. *Source:* Warren Holmes and others
- When the travel of a screw take up for an underground belt conveyor is too short, consider installing two in tandem and/or using a steel cord belt before resorting to a gravity take-up. *Source:* Ian McKelvie
- Vertical take-ups (as commonly employed on surface conveyors) can spell trouble, especially with sticky ores. A tail pulley take-up (that employs a separate counterweight tower) should be employed, or even a screw take-up. *Source:* Robert Shoemaker
- A wing snub pulley can make a good belt cleaner. *Source:* Dave Assinck
- A wing tail pulley helps prevent particles from being trapped between the belt and the pulley face that would otherwise damage the belt. *Source:* Dave Assinck
- Solid faced tail pulleys can only lead to trouble. Vane-type (wing) tail pulleys should be employed. *Source:* Robert Shoemaker
- Half-trough pulleys will shorten the transition distance at the tail end, but they can cause the belt to lift off the idlers when empty. As belt loading fluctuates, the belt line will change dramatically, so the feed zone cannot be sealed effectively. *Source:* Martin Engineering
- Designers, fabricators, and installers of inclined conveyors pay much attention to alignment at the head end where the drive is usually located. Accurate alignment of the tail end is just as important because this is where tension is least and the belt most likely to start wandering off track. *Source:* Goodyear
- Training idlers can be responsible for more problems than they correct. Their prolonged use typically results in separating the belt plies due to the sidewall tears they inflict. A good operator can keep the belt trained without training idlers. *Source:* Dave Assinck
- The traditional belt-training idler moves the belt so that it continually wanders. It often kicks back over with such force that the belt is slammed over to the other side. A new type is available that initiates and actuates training without slamming. *Source:* R. P. Sahura
- Belt training can be improved at a problem area by shimming the idlers to cant very slightly forward (direction of travel) and, if necessary, slightly off square to the direction of travel. *Source:* Goodyear
- A staggered idler spacing may be employed on long inclined conveyors to obtain a cost saving. Close spacing is not normally required at the top end where belt tension is highest. Staggered spacing should be avoided in all other cases. *Source:* Jack de la Vergne
- The calculation of tail pulley tension (manual or computer) is not accurate because the value is obtained by difference. The design of tail pulley, attachments, and take-up should make allowance for a higher design tension than is calculated. *Source:* Jack de la Vergne
- Cement or very dry concentrate should be transported by screw conveyor and not on a belt conveyor. *Source:* Mular and Bhappu
- A load-out conveyor is required to properly automate a skip hoist hoisting system. *Source:* Largo Albert
- The head pulley should always be lagged for wet service. In practice, they are invariably employed for underground mine installations and inclined conveyors on surface. *Source:* Khoa Mai
- For underground conveyors, the use of impact cassettes (slider beds) that employ low friction bar sections have gained design preference for use at load and transfer points and are replacing the one-time traditional impact idlers for this duty. *Source:* Heinz Schober

- The metal portion of skirtboards should have a minimum one-inch gap to the belt and the gap should normally be tapered wider in the direction of movement. The exception is the skirtboards on a through conveyor. In all cases, the rubber skirts on the board should just touch the belt. *Source:* Jack de la Vergne
- Skirtboards on a vibrating feeder do not touch the deck. You should taper the gap from rear to front to prevent jamming of lumps under the skirt. *Source:* Bill Potma
- A slight increase in width between feeder skirtboards from back to front will reduce friction significantly. *Source:* Bill Potma
- A slight decrease in width between feeder skirtboards from back to front will help release trapped material. *Source:* Heinz Schober
- A skirt board taper should be very slight, otherwise the width of the feeder throat may be reduced enough to invite hang-ups. A taper may not be necessary for alluvial material, such as bank sand for a backfill plant. *Source:* Jack de la Vergne
- In a hard rock mine, the product from a jaw crusher may tend to be slabby, while the product from a gyratory crusher may tend to be blocky, the latter being easier to pass through a feeder or transfer point on a conveyor system. *Source:* Heinz Schober
- It is better to feed a belt a foot or so past a constriction of the feed to accommodate any bounce-back of material caused by turbulence. *Source:* Martin Engineering
- Installing a high-side vibratory feeder eliminates the skirtboards and the inherent problems. The only price paid is a slight increase in drive motor capacity. *Source:* Heinz Schober
- A vibratory feeder that is seated on a frame or pedestal needs approximately 6 inches of lift from rest to release the mounting springs. The design should allow this clearance between the feeder skirt or any other obstruction and the bottom of the feeder pan. *Source:* Ed Cayouette
- A vibratory feeder that is suspended must be lifted to unhook the suspension and then lowered on a temporary support. A clearance of 6 inches will allow for this and other problems that may be encountered, such as adjusting the feed slope. *Source:* Ed Cayouette
- To calculate the practical capacity of an apron feeder, assume 75% of the bed is full and select a flight travel that does not exceed 50 fpm. *Source:* Dave Assinck

17.4 Belt Conveyor Design

The first step in designing a belt conveyor is to determine the following design criteria.

- Capacity [normally expressed in tons per hour (tph)].
- Layout dimensions (length, lift, and azimuth) for each leg of the conveyor.
- Material origin (ROM, grizzly, jaw crusher, cone crusher, etc.).
- Material description (SG, bulk density, angle of repose, abrasion, foliation, moisture content, pH, and contaminants).
- Material size (crusher setting, grizzly opening, screen analysis).
- Ambient conditions (temperature range, humidity, etc.).
- Applicable statutory mine regulations.
- Applicable insurance stipulations (FM).
- Access dimension and weight restrictions to reach the workplace.

When the criteria are established, the calculations may proceed. Excellent handbooks exist (i.e. Belt Conveyors for Bulk Materials, CEMA) that provide step-by-step procedures; however, it is more convenient to use a standard commercial or custom in-house computer program. Once an initial run is made, the design can be polished to reflect special conditions and to optimize standardization of components.

The CEMA handbook is considered the standard reference. CEMA procedures are typically incorporated into commercial computer programs used to design belt conveyors. The design capacity for a hard rock conveyor system is less than determined by the CEMA procedure and may be expressed as a percentage of the CEMA determination. For example, a hard rock conveyor system capacity might be expressed as being designed on the basis of 70% CEMA for the flow sheet capacity and 85% CEMA for short-term peaks.

While handbooks are valuable to understand the design process, and computer programs are mathematically perfect, they may not adequately address all requirements for a practical design. One common problem area in mines is determining the belt width that will reliably handle lumps in the ore stream. This dilemma crops up underground because capacity is not usually the final determinant for belt width. A similar problem may be found in the concentrator when narrow belts are installed at a high inclination to feed a FAG or SAG mill that wants lumps in the ore to operate efficiently.

17.5 Conveyor Belt Width

Belt width is typically first dimensioned on the basis of capacity, which is a purely mathematical exercise. Final determination often depends on the characteristics of the material on the belt, particularly particle size distribution.

Handbook Formulae

- The CEMA Handbook states that the belt width ought to be between three and five times the maximum lump size. Unfortunately, this lump size is often taken to be equal to the crusher setting. The CEMA definition of maximum lump size is later found where it states that lump size means “the largest lump that occasionally may be carried.”
- The 1992 SME Handbook states on page 2,171 that “an important factor in selecting minimum normal belt width is to select a figure that is at least three times the maximum lump size.”
- The 1973 SME Handbook shows on page 18-35 that the belt width should be equal to 3.5 times the longest dimension of the occasional lump.
- Edition III of the CE Handbook on page 1,357, Table 16, recommends a 36-inch belt for $d_{80} = 8$ inches and 42 inches for $d_{80} = 10$ inches.
- Edition VII of Mark’s Handbook (page 10-75, Table 14) recommends a 36-inch belt for 8-inch lumps and a 42-inch belt for 10-inch lumps, when “sized” (crushed) material is conveyed.

The belt width can be less for a single flight conveyor than for a conveyor involving transfer points that handles the same material. A 30-inch wide belt may be satisfactory to handle ore from a jaw crusher set at an open side of 6 inches on a straight run, but this belt will not be wide enough for a long conveyor system with transfer points, especially when the angle turned is acute.

As a general rule, a belt width of 36 inches is satisfactory for an open-side crusher setting up to 8½ inches, while a 42-inch belt is satisfactory for an open-side setting up to 10½ inches. A 54-inch belt is desired for muck passing through a 12-inch by 15-inch grizzly.

17.6 Case Histories

Table 17-1 shows belt conveyors at various Canadian Mines.

Table 17-1 Belt Conveyors at Canadian Mines

Mine	Mill Rate (tpd)	Crusher Setting	Belt Width	Secondary Crushing
Island Copper 1973	38,000	7-10 inches	36 inch (3)	FAG/SAG
Island Copper 1993	57,500	6 inches	54 inch (1)	SAG
Sullivan	7,000	6 inches	42 inch	7 foot cones
Cyprus Anvil	10,000	6 inches	42 inch	7 foot cones
McCleod (cable belt)	6,000	6 inches	30 inch	
Brunswick	10,000	6 inches	36 and 42 inch	5.5 foot cones
Denison	10,000	10 inches	42 inch	7 foot cone
Copper Cliff North	2,200	6 inches	42 inch	SAG
Copper Cliff South	2,300	7 inches	42 inch	SAG
Little Stobie	2,200	6 inches	42 inch	SAG

Table 17-1 Belt Conveyors at Canadian Mines (continued)

Mine	Mill Rate (tpd)	Crusher Setting	Belt Width	Secondary Crushing
Selbaie	1,500	6 inches	36 inch	cone
Geco	4,000	6 inches	36 inch	cones
Lyon Lake	1,250	6 inches	42 inch	cone
Mattagami	2,500	6 inches	36 inch	cones
Ruttan	4,250	6 inches	36 inch	cones
Polaris	2,050+	5 inches	36 inch	cone
Nickel Plate	3,600	4 inches	42 inch	cone
Black Lake	7,000	7 inches	36 inch	cone
Pamour Pit	1,800	5 inches	42 inch	cone
Williams Pit	330	7 inches	42 inch	
Raglan-Kattiniq	2,300	9 inches	42 inch	SAG

17.7 Power Requirements

Calculating the power requirements for a conveyor system is a tedious chore when done manually. The following procedure provides a good approximation of the drive HP required. The procedure is based on the assumption that conveyor power requirements may be determined by adding the power required to actually lift the material to the power required to lift the material a distance equivalent to the friction losses sustained by a level installation.

$$\text{Total Lift, } H = H_g + H_f$$

Table 17-2 provides the equivalent lift, H_f in feet for various conveyor belt lengths and speeds.

Table 17-2 Equivalent Lift for Belt Conveyor Lengths

Belt Speed fpm	Belt Length, feet										
	100	200	300	400	500	750	1,000	1,500	2,000	2,500	3,000
100	12.7	16.9	21.1	25.2	28.3	38.3	45.1	57.1	69.1	79.1	93.2
200	14.1	18.8	23.5	28.0	31.5	42.6	50.2	63.6	76.9	88.0	103.7
300	16.9	22.5	28.1	33.6	37.8	51.1	60.2	76.2	92.2	105.5	124.3
400	19.8	26.3	32.8	39.3	44.2	59.7	70.3	89.1	107.8	123.3	145.3
500	22.6	30.1	37.7	45.0	50.7	68.5	80.6	102.1	123.5	141.4	166.6

Example

Determine the drive power requirements for the following conditions.

- A flat (level) conveyor
- An uphill gradient of 20%

Determine the power generation potential for the following condition.

- A downhill gradient of 20%

- Facts:
1. The belt length is 1,000 feet
 2. The belt speed is 300 fpm
 3. The conveyor output is 300 tph
 4. The drive train efficiency, E is 88.5%

Solution: Output, $Q = 300 \text{ tph} = 10,000 \text{ Lbs./minute}$

Flat

$$H = H_g + H_f = 0 + 60.2 = 60.2 \text{ feet}$$

$$\text{Belt Horsepower} = QH/33,000 = 10,000 \times 60.2/33,000 = 18.2 \text{ BHP}$$

$$\text{Drive HP} = \text{BHP}/E = 18.2/0.885 = 20.6 \text{ HP}$$

Select 25 HP motor

+20%

$$H = H_g + H_f = 200 + 60.2 = 260.2 \text{ feet}$$

$$\text{Belt Horsepower} = QH/33,000 = 10,000 \times 260.2/33,000 = 78.8 \text{ BHP}$$

$$\text{Drive HP} = \text{BHP}/E = 78.8/0.885 = 89.1 \text{ HP}$$

Select 100 HP motor

-20%

$$H = H_g + H_f = -200 + 60.2 = -139.8 \text{ feet}$$

$$\text{Belt Horsepower} = QH/33,000 = 10,000 \times -139.8/33,000 = -60.5 \text{ BHP}$$

$$\text{Power generation} = -\text{BHP} \times E = 60.5 \times 0.885 = 53.5 \text{ HP}$$

$$\text{Equivalent generator output} = 53.5 \times 0.746 \cong 40 \text{ kW}$$

17.8 Computer Program

Production Capacity

A belt conveyor production capacity is normally measured by installing a belt scale (“weightometer”). The material is weighed as it passes over a “weigh bridge,” the belt speed is measured, and the results are electronically integrated to provide a rate output. These scales are obtainable off the shelf and are adaptable to both existing and new conveyor belt installations. An accuracy of over 99% may be obtained with proper calibration.

A simple system was developed to verify the weightometer results or to determine the output when no weightometer is installed. In this method, the loaded conveyor is stopped and a measured length of material on the belt is removed and weighed. The length of material removed is compared with a specified length that will result in short tons from a measurement in pounds. The specified length may be obtained from the following formula.

$$L = 3V/100$$

In which L = specified length (feet) and V = belt speed (fpm)

Example

Determine the conveyor output for the following case.

- Facts:
1. The belt speed is 200 fpm
 2. The material on a 5'-0 length of belt weighs 250 Lbs.

Solution:

The specified belt length = $3 \times 200/100 = 6.00$ feet
 The weight on the specified length = $250 \times 6/5 = 300$ Lbs.
 The conveyor output = 300 tph

17.9 Friction Around a Circular Drive

The following relationship can be used to relate the tensions to friction around the drum of a conveyor drive pulley.

μ = Coefficient of friction
 θ = Contact angle (in radians)

$$\frac{T_1}{T_2} = e^{\mu \theta}$$

For rubber belts on a bare steel drum, $\mu = 0.30$ (dry), $\mu = 0.18$ (wet)
 For rubber belts on a ribbed, rubber-lined drum, $\mu = 0.42$

17.10 Feeder Selection and Design

A feeder is employed to maintain and control bulk material (crushed ore) being transferred from a static source (bin) to another device (moving belt, stationary crusher) to optimize capacity and reliability. A feeder is not normally required at a transfer point from one conveyor to another. (A "belt bender" that employs the same belt after the change in direction is not normally used in hard rock mines.) The transfer point, if well designed, will alter the travel of material to the new direction while maintaining the forward flight velocity at belt speed.

For open pit operations, apron feeders are commonly employed. One reason for employment is their flexibility with respect to flight angle. For underground mines, the popular choice in North America is the vibratory feeder because it is less expensive to purchase, usually reliable, provides ready access for maintenance, and normally is less costly to maintain.

Other types, such as a belt feeder, hydro-stroke feeder, or apron feeder may better handle some ores that are particularly abrasive, lumpy, or sticky. Of these, the apron feeder is most often employed. The apron feeder is relied upon in mines of the former Soviet Union and a few large mining companies elsewhere. The belt feeder has become the method of choice for feeding a conveyor load out beneath a gyratory crusher installation.

For ores that are free flowing (and will stay free flowing), the Mexican feeder (as installed at Bougainville and Cortez) is a viable choice and is the least expensive of all.

In the past, sometimes a "picking" belt was employed after the feeder that was wider and slower than the main belt. It was also practice to feed a belt with a finger or scalping grizzly that allowed fine particles to fall first, providing a bed to lessen impact from the coarse feed. Neither of these procedures is as popular today, but there is still occasional good application for the second procedure.

Feeder capacity should at least match belt capacity. The feeder model required for a particular application can be selected from manufacturers' catalogues that provide tables and guidelines for this purpose.

Feeders employed underground today are not really efficient. They use more energy shearing off the material from its static consolidation and overcoming friction than they do accelerating the material to belt speed. New feeder designs (used elsewhere) that employ gravity alone to overcome friction and shear and provide acceleration may soon be available for practical application in hard rock mines.

18.0 Ventilation and Air Conditioning

18.1 Introduction

The historic role of ventilation was to provide a flow of fresh air sufficient to replace the oxygen consumed by the miners working underground. Contemporary mine ventilation primarily deals with noxious gases (mainly generated by trackless equipment underground). Ventilation effectiveness in this role depends on a simple fact: "once the noxious gases are mixed with air, they will remain uniformly diffused and will never separate." Therefore, if the problem gases (NO_x , SO_2 , CH_4 , CO , etc.) are diluted at their source with enough fresh air to render them harmless, they will remain safe until eventually exhausted from the mine. In the typical underground trackless mine, the amount of ventilation air required to ensure adequate dilution is far more than the amount required to replace oxygen consumed underground by personnel and diesel engines. The required amount of air is also sufficient to improve visibility and remove rock dust generated underground to the extent that silicosis is no longer a serious threat.

Today, LHD engines in underground hard rock mines are equipped with catalytic exhaust scrubbers to complete combustion of problem gases that is accomplished at an efficiency of approximately 90%. The LHD engines also produce minute solid particles (diesel particulate matter – DPM) due to incomplete combustion and impurities in the fuel. This matter consists of impregnated carbon and a variety of organic compounds, such as paraffin, aldehydes, and poly-nuclear aromatic hydrocarbons. Some of these compounds are recognized carcinogens. Unfortunately, the catalytic scrubber is not efficient at removal of these particulates and moreover they may not remain uniformly distributed in the exhaust air of the mine (they are subject to stratification). Dealing with this problem has recently become a prime focus of attention by regulators and operators.

The highest operating cost to provide contemporary mine ventilation is the electrical energy for the fans, which typically represents more than one-third of the entire electrical power cost for a typical underground mine.

The minimum quantity of fresh air is stipulated in the mine regulations that apply at the mine's location. The legal minimum is normally sufficient; however, an increase may be necessary when the mine regulations are insufficient (some developing countries) or to cool a hot mine.

Uranium mine ventilation is governed by different considerations and separate mine regulations. Uranium mines and other mines that encounter natural radiation are an advanced science that is not pursued in this handbook.

For common ventilation calculations, procedures assume the air is an incompressible fluid that answers to D'Arcy's equation. The formulae and calculations, based on work by Atkinson and McElroy, employ empirical "friction factors" that do not take into full account variations in pressure, temperature, evaporation/condensation, etc. In most cases, the simplified procedures yield satisfactory results; however, when mine air must be circulated over a significant vertical distance, or when air is required for cooling, a more sophisticated analysis is usually necessary.

Even when the simplified formulae are used, the calculations required for analyzing the network of airways in an existing or proposed mine are cumbersome. The difficulty is exasperated because the ventilation circuit for an operating mine changes day by day. In response, computer programs were pioneered and developed for practical application (Hashimoto - 1961, Hartman and Trafton - 1963, McPherson - 1966). Today, most network ventilation problems are solved by computer using in-house programs or off-the-shelf commercial software.

In temperate climates, ventilation air may have to be heated during the winter months to provide comfort to the miners and avoid freezing the workings. Conversely, mines in Arctic regions may need cold air all year to maintain the permafrost regime. These "cold" mines are designed to operate below the freezing point. Hot mines in temperate or tropical climates typically require the air to be cooled. Deep underground mines always encounter warmer rock temperatures and the air is naturally warmed by adiabatic or auto-compression as it travels downward. Cooling by means of the ventilation air alone can become inadequate. More efficient cooling is obtained by chilling and adding ice to the process water delivered underground. Less efficient local (spot) cooling is provided by the release of compressed air underground and other means.

Note

Stantec wishes to gratefully acknowledge the kind assistance provided by Dr. Pierre Mousset-Jones at the Mackay School of Mines in Nevada. By canvassing his colleagues on our behalf, he was able to provide up-to-date information and advice for this new edition of the handbook.

18.2 Rules of Thumb

Notes

Ventilation is generally thought of as a highly developed science. It is therefore surprising that it encompasses more rules of thumb than any other mining discipline. As pointed out in the introduction to this handbook, rules of thumb are frequently sufficient to quickly provide approximate answers that facilitate the problem solving process. The eminent American theoretical physicist, Enrico Fermi, often demonstrated that a complicated problem could be divided into simple ones, allowing one with perception and insight to rapidly assimilate a reliable estimate of the answer. Therein lies the value of the rules of thumb.

Ventilation circuits are obviously sensitive to local climate, cost of electricity and local regulations. As a result, some rules of thumb do not have universal application. Moreover, there are some distinct differences in the ventilation strategy applied to hard rock mines and those that mine coal, salt, or industrial minerals.

The Forward to this handbook (see front pages) further explains the proper use and limitations of the rules of thumb.

General

- An underground trackless mine may require 10 tons of fresh air to be circulated for each ton of ore extracted. The hottest and deepest mines may use up to 20 tons of air for each ton of ore mined. *Source:* Northern Miner Press

- The following factors may be used to estimate the total mine air requirements in mechanized mines not requiring heat removal: 0.04 m³/s/tonne (77cfm/ton)/day (ore + waste rock) for bulk mining with simple geometry; 0.08 m³/s/tonne (154 cfm/ton)/day (ore) for intensive mining with complex geometry. *Source:* Robin Oram

- A mechanized cut-and-fill mine with diesel equipment typically has an airflow ratio of 12 t of air per t of ore. A non-dieselized mine has a ratio of 7:1. A large block cave operation might range from 1.7 to 2.6:1. *Source:* Pierre Mousset-Jones

- A factor of 100 cfm per ore-ton mined per day can be used to determine preliminary ventilation quantity requirements for most underground mining methods. Hot mines using ventilation air for cooling and mines with heavy diesel equipment usage require more air. Uranium mines require significantly higher ventilation quantities, up to 500 cfm per ton per day. Block cave and large-scale Room and Pillar mining operations require significantly lower ventilation quantities, in the range of 20 to 40 cfm per ton per day for preliminary calculations. *Source:* Scott McIntosh

- The very deep gold mines in South Africa use an approximate upper limit of 0.12m³/s (254 cfm) per tonne mined per day and then resort to refrigeration. *Source:* Jozef Stachulak

- The practical limit for ventilating a deep, hot mine before resorting to refrigeration is one cfm per tonne of ore mined per year. *Source:* Mike Romaniuk

- Ventilation is typically responsible for 40% of an underground mine's electrical power consumption. *Source:* CANMET

- If the exhaust airway is remote from the fresh air entry, approximately 85% of the fresh air will reach the intended destinations. If the exhaust airway is near to the fresh air entry, this can be reduced to 75%, or less. The losses are mainly due to leaks in ducts, bulkheads, and ventilation doors. *Source:* Jack de la Vergne

- Approximately 50% of the fresh air will reach the production faces in a mine with one longwall and two to three development headings. *Source:* J.D. McKenzie

- Mine Resistance – for purposes of preliminary calculations, the resistance across the mine workings between main airway terminals underground (shafts, raises, air drifts, etc.) may be taken equal to one-inch water gauge. *Source:* Richard Masuda

- Natural pressure may be estimated at 0.03 inches of water gage per 10 degrees Fahrenheit difference per 100 feet difference in elevation (at standard air density). *Source:* Robert Peele

- For a mine of depth 3,000 feet, the natural ventilation pressure amounts up to approximately 4 inches w.g. *Source:* Skochinski and Komarov

Airways

- The maximum practical velocity for ventilation air in a circular concrete production shaft equipped with fixed (rigid) guides is 2,500 fpm (12.7m/s). *Source: Richard Masuda*

- The economic velocity for ventilation air in a circular concrete production shaft equipped with fixed (rigid) guides is 2,400 fpm (12m/s). If the shaft incorporates a man-way compartment (ladder way) the economic velocity is reduced to about 1,400 fpm (7m/s). *Source: A.W.T. Barenbrug*

- The maximum velocity that should be contemplated for ventilation air in a circular concrete production shaft equipped with rope guides is 2,000 fpm and the recommended maximum relative velocity between skips and airflow is 6,000 fpm. *Source: Malcom McPherson*

- The “not-to-exceed” velocity for ventilation air in a bald circular concrete ventilation shaft is 4,000 fpm (20m/s). *Source: Malcom McPherson*

- A common rule of thumb for maximum air velocity for vent raises is 3,000 fpm (15m/s). *Source: Doug Hambley*

- The typical velocity for ventilation air in a bald circular concrete-lined ventilation shaft or a bored raise is in the order of 3,200 fpm (16m/s) to be economical and the friction factor, *k*, is normally between 20 and 25. *Source: Jack de la Vergne*

- The typical velocity for ventilation air in a large raw (unlined) ventilation raise or shaft is in the order of 2,200 fpm (11m/s) to be economical and the friction factor, *k*, is typically between 60 and 75. *Source: Jack de la Vergne*

- At the underground mines of the Northeast (U.S.A.), ventilation air may not be heated in winter. To avoid unacceptable wind chill, the common rule of thumb for the velocity of downcast ventilation air in shafts used for man access is 800 feet per minute (4m/s). *Source: Doug Hambley*

- A raw (unlined) raise should be designed from 1-1.25 inches of water gauge per thousand feet. *Source: David Cornthwaite (Author’s note – this rule is considered by others to be conservative).*

- The typical range of ventilation air velocities found in a conveyor decline or drift is between 500 and 1,000 fpm. It is higher if the flow is in the direction of conveyor travel and is lower against it. *Source: Floyd Bossard*

- The maximum velocity at draw points and dumps is 1,200 fpm (6m/s) to avoid dust entrainment. *Source: John Shilabeer*

- A protuberance into a smooth airway will typically provide four to five times the resistance to airflow as will an indent of the same dimensions. *Source: van den Bosch and Drummond*

- The friction factor, *k*, is theoretically constant for the same roughness of wall in an airway, regardless of its size. In fact, the factor is slightly decreased when the cross-section is large. *Source: George Stewart*

Ducts

- For bag duct, limiting static pressure to approximately 8 inches water gage will restrict leakage to a reasonable level. *Source: Bart Gilbert*

- The head loss of ventilation air flowing around a corner in a duct is reduced to 10% of the velocity head with good design. For bends up to 30 degrees, a standard circular arc elbow is satisfactory. For bends over 30 degrees, the radius of curvature of the elbow should be three times the diameter of the duct unless turning vanes inside the duct are employed. *Source: H.S. Fowler*

- The flow of ventilation air in a duct that is contracted will remain stable because the air-flow velocity is accelerating. The flow of ventilation air in a duct that is enlarged in size will be unstable unless the expansion is abrupt (high head loss) or it is coned at an angle of not more than 10 degrees (low head loss). *Source: H. S. Fowler*

Fans

- Increasing fan speed by 10% may increase the quantity of air by 10%, but the power requirement will increase by 33%. *Source: Chris Hall*

 - For quantities exceeding 700,000 cfm (330 m³/s), it is usually economical to twin the ventilation fans. *Source: William Meakin*

 - The proper design of an *evasée* (fan outlet) requires that the angle of divergence not exceed 7 degrees. *Source: William Kennedy*
-

Air Surveys

- A pitot tube should not exceed 1/30th the diameter of the duct. *Source:* William Kennedy
- For a barometric survey, the correction factor for altitude may be assumed to be 1.11 kPa/100m (13.6 inches water gage per thousand feet). *Source:* J.H. Quilliam

Clearing Smoke

- The fumes from blasting operations cannot be removed from a stope or heading at a ventilation velocity less than 25 fpm (0.13m/s). A 30% higher air velocity is normally required to clear a stope. At least a 100% higher velocity is required to efficiently clear a long heading. *Source:* William Meakin
- The outlet of a ventilation duct in a development heading should be advanced to within 20 duct diameters of the face to ensure it is properly swept with fresh air. *Source:* J.P. Vergunst
- For sinking shallow shafts, the minimum return air velocity to clear smoke in a reasonable period of time is 50 fpm (0.25m/s). *Source:* Richard Masuda
- For sinking deep shafts, the minimum return air velocity to clear smoke in a reasonable period of time is 100 fpm (0.50m/s). *Source:* Jack de la Vergne
- For sinking very deep shafts, it is usually not practical to wait for smoke to clear. Normally, the first bucket of men returning to the bottom is lowered (rapidly) through the smoke. *Source:* Morris Medd

Mine Air Heating

- To avoid icing during winter months, a downcast hoisting shaft should have the air heated to at least 5^oC (41^o F). A fresh air raise needs only 1.5^oC (35^o F). *Source:* Julian Kresowaty
- When calculating the efficiency of heat transfer in a mine air heater, the following efficiencies may be assumed.
 - 90% for a direct fired heater using propane, natural gas or electricity
 - 80% for indirect heat transfer using fuel oil

Various Sources

- When the mine air is heated directly, it is important to maintain a minimum air stream velocity of approximately 2,400 fpm across the burners for efficient heat transfer. If the burners are equipped with combustion fans, lower air speeds (1,000 fpm) can be used. *Source:* Andy Pitz
- When the mine air is heated electrically, it is important to maintain a minimum air stream velocity of 400 fpm across the heaters. Otherwise, the elements will overheat and can burn out. *Source:* Ed Summers

Heat Load

- The lowest accident rates are related to men working at temperatures below 70 degrees F and the highest to temperatures of 80 degrees and over. *Source:* MSHA
 - Auto compression raises the dry bulb temperature of air by about 1 degree Celsius for every 100m the air travels down a dry shaft. (Less in a wet shaft.) The wet bulb temperature rises by approximately half this amount. *Various Sources*
 - At depths greater than 2,000m, the heat load (due to auto compression) in the incoming air presents a severe problem. At these depths, refrigeration is required to remove the heat load in the fresh air as well as to remove the geothermal heat pick-up. *Source:* Noel Joughin
 - At a rock temperature of 50 degrees Celsius, the heat load into a Room and Pillar stope is about 2.5 kW per square meter of face. *Source:* Noel Joughin
 - In a hot mine, the heat generated by the wall rocks of permanent airways decays exponentially with time – after several months it is nearly zero. There remains some heat generated in permanent horizontal airways due to friction between the air and the walls. *Source:* Jack de la Vergne
 - A diesel engine produces 200 cubic feet of exhaust gases per Lb. of fuel burned and consumption is approximately 0.45 Lb. of fuel per horsepower-hour. *Source:* Caterpillar® and others
-

Heat Load (continued)

- Normally, the diesel engine on an LHD unit does not run at full load capacity (horsepower rating); it is more in the region of 50%, on average. In practice, all the power produced by the diesel engines of a mobile equipment fleet is converted into heat and each horsepower utilized produces heat equivalent to 42.4 BTU per minute. *Source: A.W.T. Barenbrug*

- The heat load from an underground truck or LHD is approximately 2.6 times as much for a diesel engine drive as it is for electric. *Source: John Marks*

- The efficiency of a diesel engine can be as high as 40% at rated RPM and full load, while that of an electric motor to replace it is as high as 96% at full load capacity. In both cases, the efficiency is reduced when operating at less than full load. *Various Sources*

- Normally, the electric motor on an underground ventilation fan is sized to run at near full load capacity and it is running 100% of the time. In practice, all the power produced by the electric motor of a booster fan or development heading fan is converted into heat and each horsepower (33,000 foot-Lb./minute) produces heat equivalent to 42.4 BTU per minute. (1 BTU = 778 foot-Lbs.) *Source: Jack de la Vergne*

- Normally, the electric motor on a surface ventilation fan is sized to run at near full load capacity and it is running 100% of the time. In practice, about 60% of the power produced by the electric motors of all the surface ventilation fans (intake and exhaust) is used to overcome friction in the intake airways and mine workings (final exhaust airways are not considered). Each horsepower lost to friction (i.e. static head) is converted into heat underground. *Source: Jack de la Vergne*

- Heat generated by electrically powered machinery underground is equal to the total power minus the motive power absorbed in useful work. The only energy consumed by electric motors that does not result in heat is that expended in work against gravity, such as hoisting, conveying up grade, or pumping to a higher elevation. *Source: Laird and Harris*

Air Conditioning and Refrigeration

- In the Republic of South Africa, cooling is required when the natural rock temperature reaches the temperature of the human body (98.6 degrees F). *Source: A.W.T. Barenbrug*

 - A rough approximation of the cooling capacity required for a hot mine in North America is that the tons of refrigeration (TR) required per ton mined per day is 0.025 times the difference between the natural rock temperature (VRT) and 95 degrees F. For example, a 2,000 ton per day mine with a VRT of 140 degrees F. at the mean mining depth will require approximately $0.025 \times 45 \times 2,000 = 2,250$ TR. *Source: Jack de la Vergne*

 - Enclosed operator cabs that are air-conditioned and air-filtered should be designed for 80% recirculation and a positive cabin pressure of 0.25 inches water gauge. *Source: John Organiscak*

 - The cold well (surge tank) for chilled surface water should have a capacity equal to the consumption of one shift underground. *Source: J. van der Walt*

 - At the Homestake mine, the cost of mechanical refrigeration was approximately equal to the cost of ventilation. *Source: John Marks*
-

18.3 Tricks of the Trade

- Benchmarking the ratio between the mass flow of air and the mass flow of ore is a good technique to compare a subject mine with similar operations elsewhere. This ratio is dimensionless and because the time variable cancels out, international comparisons are facilitated. *Source: Pierre Mousset-Jones*
- To quickly estimate the annual power cost of a main ventilation fan in dollars, simply multiply the fan horsepower by 65 times the total cost per kWh in cents. For example, at 5 cents per kWh, the annual power cost for a 2,000 HP fan will be $2,000 \times 65 \times 5 = \$650,000$. If only the energy cost is known, multiplying by 100 (instead of 65) will take the demand cost and surcharges on the power bill into account. *Source: William Meakin*
- To quickly estimate the annual power cost for a mine's primary ventilation system, simply multiply the unit power cost in cents per kilowatt hour by the total pressure drop in inches water gage and again by the total airflow in cfm. Then divide by 80 to obtain the annual power cost in dollars. For example, at 5 cents per kilowatt hour, the annual power cost for a mine with 800,000 cfm at 20 inches water gage will be $5 \times 20 \times 800,000/80 = \$1,000,000$. *Source: C. E. Gregory*

- An in-line fan will collapse flexible ducting. This can be avoided by providing a gap between the fan and the duct behind it. *Source:* Bob Steele
- A silencer on a ventilation fan at surface for a shaft sinking or ramp drive is often not sufficient. Usually the answer is to employ a double silencer. *Source:* Denis Blais
- When a mine is being developed, a long heading from a shaft may be best served by a pull system (suction duct), while the shaft is already served by a push system. The conflict can be overcome by extending the suction duct up the bottom portion of the shaft. *Source:* Gabby Juteau
- If a pull system (suction duct) is employed for a long drive, it has the advantage of removing smoke (blasting fumes) much more rapidly. The end of the duct must be kept 200 feet (60m) from the face to prevent damage by fly rock. Unfortunately, this produces a “dead end” at the face. The problem is corrected by employing a small, portable auxiliary fan that can force fresh air towards the face – often through an 8-inch (200mm) diameter flexible ducting. *Source:* Robert Mayo
- In a long drift or diesel alimak raise heading that is too small in section to accommodate a typical ventilation duct, a much smaller diameter duct may be employed if a “blower” (low pressure air compressor) is employed instead of a ventilation fan. *Source:* McNally and Sons
- The published friction factors for hard rock mines found tabulated in textbooks were typically derived many years ago when mine headings were much smaller than they are now. In addition, the figures were intended to include an allowance for shock losses at entrance or exit. These values are not accurate enough to provide reliable answers for today's mines, especially for long headings. Using 2/3 of the values listed will often give answers that are reliable for most modern mining applications. *Source:* Jack de la Vergne
- The estimation of the required water gage of a mine fan by different engineers for the same application can vary widely. This is one reason why axial flow fans are usually selected for underground hard rock mines. If the motors and switchgear are ordered oversize, the problem can be addressed. *Source:* Chris Hall
- Vane-axial fans are not always the best choice for primary circuits. Centrifugal fans are cost competitive, quieter, less likely to have problems (stalling, vibration, balance), and require less maintenance. *Source:* John Marks
- For main fans, it is preferable to install two fans in parallel rather than a single unit. The reason is that one fan will supply 66% of the normal air capacity while the other (sealed off) is down for repairs. It is better still to select 3 fans, two of which will supply 90% of the normal air capacity. This is usually enough to maintain full production. *Source:* A.W.T. Barenbrug
- The main exhaust fans at a base metal mine should normally be equipped with stainless steel or aluminum blades to inhibit corrosion. *Various Sources*
- In a rail heading, the vent duct is usually best hung at the apex of the arch. In a flat-backed trackless heading, it will be best protected if it is hung high on the wall on the ditch side. *Source:* Jack de la Vergne
- A common misconception is that the addition of water vapor to dry air increases its density (“weight”). In fact, moist air is very slightly lighter than dry air at the same temperature and pressure, although its specific heat is increased. *Source:* Andy Pitz
- When calculating the pressure loss for a long heading served by a ventilation duct, only the resistance of the duct need be considered. The resistance of the heading is negligible by comparison. *Source:* William Meakin
- In large stopes, it is often not practical to provide through ventilation at the velocity required to clear smoke. A high-velocity auxiliary fan (with no duct attached) may be used to direct an air stream sufficient to displace smoke from a working area. *Source:* Bill Wright
- A change to seven days per week operations underground eliminates the opportunity to carry out large blasts on the weekend and may result in a large increase in air requirements to maintain acceptable working conditions. *Source:* Jozef Stachulak
- Most methods to calculate natural ventilation pressure are based on the assumption that it is due to differential air density. This assumption is erroneous. (Natural ventilation is caused by the conversion of heat into mechanical energy.) Nevertheless, considering air density provides results accurate enough for practical application. *Source:* Howard Hartman
- To prevent turning vanes in a duct from “singing,” it is often advisable to lace them with wires welded across the leading edges of the vanes and to the duct wall. The wire thickness should be at least equal to the thickness of the vanes. *Source:* H. S. Fowler
- The air resistance of a mineshaft containing a manway may be significantly reduced (as much as 57%) by means of placing a smooth walled brattice to separate this compartment from the main airflow. *Source:* Glükauf (S. Bär)
- A haulage ramp should not carry ventilation air in the same direction and velocity as a loaded haulage truck. Otherwise, a cloud of exhaust smoke and dust will envelop the truck as it travels. *Source:* Bob Brown

- An exhaust shaft or raise from a deep mine should not carry ventilation air at velocities in the vicinity of 10m/s (2,000 fpm). Air entering the bottom of an upcast airway is saturated and as it rises, the temperature drops due to auto-decompression and vapor condenses. The droplets of water will fall or rise depending on the air velocity, except at about 10m/s, where they will remain suspended until a water blanket builds up that throttles the airflow. This will eventually (as little as two hours) stall the vent fans, at which point the suspended water blanket cascades down the airway, and the fan usually starts up again. *Source:* J. de V. Lambrechts
- If the main ventilation fans fail at a deep mine, natural ventilation can permit safe evacuation. If the event occurs during winter when the intake air is heated, the mine air heaters should be shut off to increase the natural flow of air. *Source:* Jack de la Vergne
- In the heat balance calculation for a hot mine, the amount of heat generated by blasting operations, body metabolism, and electrical cables is relatively insignificant. It can be considered offset by the cooling effect of releasing compressed air – without sacrificing accuracy of the heat balance, as a whole. *Source:* Jack de la Vergne
- In the heat balance calculation for a hot mine, the amount of heat generated by the hydration of Portland cement (85-100 cal/gram) and fly ash binder in backfill is relatively insignificant. It can be considered offset by the cooling effect of the water and solids in the backfill sent underground at surface temperature – without sacrificing accuracy of the heat balance, as a whole. *Source:* Jack de la Vergne
- When ore or waste rock descends in a pass, the loss of potential energy is divided between attrition (comminution of ore/rock) and heat of friction. In the heat balance calculation for a hot mine, the amount of heat generated is relatively insignificant and may be ignored without sacrificing accuracy of the heat balance, as a whole. *Source:* Jack de la Vergne
- In the heat balance calculation for a hot mine, the amount of heat generated by broken ore and rock is typically the principal source of heat input. It can be significantly increased in a base metal mine by oxidation of the broken ore. Therefore, the ore handling system should be designed to remove broken ore and rock quickly. In other words, shrinkage stoping, “deferred pull,” and over-sized underground bins should be avoided. *Source:* Jack de la Vergne

18.4 Conversion Factors

Table 18-1 shows conversion factors using metric and imperial units.

Table 18-1 Conversion Factors

Conversion using Metric and Imperial Units
1 m ³ /s = 2,120 cfm
1 l/s = 2.12 cfm
1 kPa = 4.02 inches water gage
1 bar = 100 kPa
1 bar = 14.50 psi
1 bar = 401.8 inches water gage
1 psi = 27.7 inches water gage

18.5 Constants and Typical Values

Table 18-2 shows the applicable constants and values.

Table 18-2 Constants and Values

Absolute zero	-459 ⁰ F (-273 ⁰ C)
Standard Temperature & Pressure	STP is 60 ⁰ F @ 14.70 psi
Standard Temperature & Pressure	STP is 15.5 ⁰ C @ 101 kPa
Specific heat of air (constant pressure)	C _P =0.24 Btu/Lb./ ⁰ F
Specific heat of air (constant volume)	C _V =0.17 Btu/Lb./ ⁰ F
Specific heat of vapor (constant pressure)	0.45 Btu/Lb./ ⁰ F
Latent heat of vaporization	1060 Btu/Lb. of water
Latent heat of freezing	144 Btu/Lb. of water
Density of water vapor at STP	0.0475 Lb. /cubic foot
Density of dry air at STP	0.0764 Lb. /cubic foot
Density of saturated air at STP	0.0759 Lb. /cubic foot
Gas constant for dry air, $\gamma = C_P/C_V$	1.404

Notes

- 1 Btu = Heat required to raise the temperature of 1 Lb. of H₂O by 1°F
- 1 Btu ≈ Heat required to raise the temperature of 1 cu. foot of air by 60°F
- 1 Btu ≈ Heat required to raise 1 cfm of air through 1°F for one hour
- 1 Btu ≈ 1 kJ, 1 Btu = 1.054 kJ (kilojoules)
- 1 Btu = 778 foot-Lbs.
- 1 ton of refrigeration = 200 BTU/min = 3.517 kW

18.6 Design of the Primary Ventilation Circuit

McElroy first proposed an ideal ventilation circuit for an underground metal mine in 1935. He placed the fans on surface at two return airshafts on the extremities of the orebody. Fresh air was drawn down the operating (production) shaft, which was located near the center of the ore zone. Control of airflow was provided by doors placed on either side of the production shaft at each operating level.

Twenty-six years later, Hartman proposed a similar layout.

"The ideal arrangement of main openings is to locate the intake airway(s) at or near the center of operations and to ring the active mining areas with exhaust airways. In practice, this is never completely realized for obvious reasons.

"Utilization of a hoisting shaft as a main airway may seriously damage both the operational and ventilation functions of the shaft. In cold climates (e.g. Canada), it is conventional to nearly neutralize the hoisting shaft. This practice requires provision of additional openings to serve as airways ... the separation of the hoisting and ventilation functions in shafts appears to be preferable."

Hartman, 1961

This latter circuit (with separate entries for fresh and exhaust air) is the one typically recommended by ventilation consultants and the one most desired by operators. Unfortunately, for very deep mines it is cost prohibitive. In this case the production shaft must be designed as a primary ventilation airway (normally the fresh air entry).

In the ideal case, with a simple application there is a main ventilation shaft or raise from surface at the extremities of the orebody, one for fresh air (FAR) and one for return air (RAR). With surface fans at both the FAR and RAR, the neutral point is centrally located within the mine workings and this arrangement is said to provide the best circuit to simplify the control over the distribution of air within the mine network. Forced ventilation with a fan only at the FAR is not usually employed except in temporary or special circumstances.

Recently, it has become popular to have the major fan installation at the RAR only. In theory, this arrangement avoids the requirement for air locks and (when there is a power failure) stagnant air from dead ends will not be drawn into active mine workings. It is also easier to eliminate velocity pressure loss with a properly designed *evasée* (outlet). The disadvantage is that the fans are more susceptible to erosion from exhaust air than clean air. In temperate climates, a small fan is usually placed at the FAR when mine air heating is required for the winter months. If the production shaft is downcast (normal preference), a separate entry into the shaft for ventilation air is provided. A small fan is installed to avoid pulling cold air down through the collar from the headframe during winter. The slight positive pressure from the small fan controls the leakage of heated air back through the shaft collar into the headframe.

When a ramp entry is required to be downcast with forced air, it is practical to drive a vertical entry raise (or separate horizontal entry) extending to surface from a point near the portal of the ramp. Leakage is prevented with the installation of double ventilation doors (air lock) between the raise and the mouth of the portal. When a ramp entry is upcast, warm saturated exhaust air from underground meeting cool ambient air on surface will precipitate a thick mist or fog at the portal, which may become a significant problem. In some cases, infra-red "fog cutters" were employed with success, but a better means is likely to exhaust the return air through a short raise (or adit) similar to the one previously described for fresh air.

The design and construction of a separate ventilation entry to a ramp or adit is usually straightforward; however, the same is not true of the entry ("plenum" or "ogee") into a production shaft. Normal practice is to sacrifice some losses by designing an entry that is safe, economical, and practical to build. The entry is best designed with a cross section equal or greater than the cross sectional area of the shaft (to avoid instability of the air stream due to expansion). The maximum air velocity in the plenum is restricted to 2,400 fpm (12m/s) to reduce the effect of shock and turbulence. When a right angle is required to meet a horizontal section that leads to the shaft, the outside corner is built square but later "smoothed" with falsework. At the shaft, the lip of the entry is permanently chamfered and small corners remaining in this "sub-collar" are filled with shotcrete.

Usually, the permanent mine ventilation will not be required until a long time after the production shaft collar is first constructed. To save time and conserve capital, it is common practice to construct only that portion of the ventilation plenum adjacent to the shaft along with the shaft collar. A temporary bulkhead is provided for this stub, to be removed at a later date when construction of the permanent ventilation system is required.

18.7 Natural Ventilation

In hilly or mountainous terrain, if there is a large difference between the temperature of the rock underground and the atmosphere, significant amounts of ventilation air will flow from an entry at one elevation to an exit at another. The airflow may become stagnant and then reverse direction from day to night or summer to winter. To provide reliable airflow, mechanical ("forced") ventilation is required. It should be designed capable of accommodating (and not fighting) the natural ventilation pressure, although this may not be practical at some installations.

Many hard rock miners consider that natural ventilation is of no consequence to force ventilated underground mines that have entries at a similar elevation on surface. In fact, all underground mines are subjected to the effects of natural ventilation. Moreover, each individual loop in the underground circuit is affected.

In cool shallow mines that are less than 1,500 feet (450m) deep, the effect of natural ventilation is not reliable. The airflow due to natural ventilation can tend to flow in either direction, or not at all. Fortunately, the pressures generated by natural ventilation in this case are not usually significant and may be ignored in routine calculations for mechanical ventilation.

In hot shallow mines and in deep mines, the rock temperature is higher than atmospheric temperature; hence there is a transfer of energy to the ventilation air. The effect is to induce natural ventilation that invariably acts in favor of (improves) the mechanical ventilation system. It may be sufficient by itself to permit safe exit from the mine in the event of a major power failure.

Case History

A definitive case study of natural ventilation pressure (NVP) was carried out at the Cayuga Mine in upper New York State during 1999 and 2000 (Mining Engineering, March 2002, page 37). At this salt mine, the mining horizon is 2,312 feet (705m) below surface. During the hot summer season, the NVP was measured at 3½ inches w.g. acting against the fans, while in winter, it measured 2 inches w.g. in favor of the fans, thereby increasing the airflow 17% (310,000 cfm from 265,000 cfm measured in summertime).

18.8 Design of Ventilation Shafts and Raises

The area (A) of a ventilation entry to a mine required for a given flow of air (Q) may be quickly determined with rules of thumb that provide a typical design velocity (V) and the following elementary formula:

$$Q = VA \text{ (metric or imperial units)}$$

Table 18-3 provides approximate diameters required for circular shafts and circular raises at different quantities of airflow for typical optimum design velocities. The diameters determined from these tables are useful for preliminary work and provide a means to check for planning blunders. The air velocities for open entries shown in the chart are sometimes exceeded in shallow mines (shorter lengths of entry). The velocities shown for equipped shafts should not be exceeded by more than 10% in any event.

Table 18-3 Diameters for Circular Shafts and Raises

Diameters for Circular Ventilation Entries to Underground Mines					
	Open Raw (Unlined)	Open Raisebored (Unlined)	Open Concrete Lined	Equipped Concrete Lined Steel Sets	Equipped Concrete Lined Rope Guides
Typical Design Velocity	2,700 fpm	3,300 fpm	3,200 ¹ fpm	2,200 fpm	1,800 fpm
Typical K	60-75	20-25	20-25	100 -150	25-30
Circular Shaft or Raise Diameter Required (feet)					
Airflow (cfm)	Open Raw (Unlined)	Open Raisebored (Unlined)	Open Concrete Lined	Equipped Concrete Lined Steel Sets	Equipped Concrete Lined Rope Guides
250,000	10.9	9.8	10.0	12.0	13.3
500,000	15.4	13.9	14.1	17.0	18.8
750,000	18.8	17.0	17.3	20.8	23.0
1,000,000	21.7	19.6	19.9	24.1	26.6
1,250,000	24.3	22.0	22.3	26.9	29.7
1,500,000	26.6	24.1	24.4	29.5	32.6

¹ At a location where the cost of electricity is low, the economical velocity may be higher in the case of an extremely deep ventilation shaft that also benefits from natural ventilation pressure.

Example

Find the diameter, D, of a raise-bored hole equivalent to a proposed 10 by 10 (3m by 3m) alimak raise intended for ventilation.

- Facts:
1. The raisebored hole is equivalent to a proposed 10 by 10 (3m by 3m) alimak raise
 2. The alimak raise is intended for ventilation

- Solution:
1. For an arbitrary length of raise (say 1,000 feet) the resistance, R of the alimak raise is $R = kPL/5.2 A^3 = 70 \times 40 \times 1,000/5.2 \times 100^3 = 0.538$.
 2. If D is the diameter of the raisebored hole, its resistance, $kPL/5.2 A^3$ may be expressed as $R = 64kL/5.2\pi^2 D^5 = 0.538$.
 3. If k is 25 for the bored raise, then $D^5 = 64 \times 25 \times 1,000/27.6 = 57,970$ and $D = 9.0$ feet.

18.9 Friction Factor for an Equipped Mineshaft

The "friction factor" in this case includes skin friction and the frictional equivalent of turbulence (shock) resulting from disturbance to the air stream at the buntons and stations. The friction factor of a shaft that incorporates sets, utility lines, and conveyances is typically at least five times that of a bald shaft. This is one reason that production and service shafts are normally not used as primary ventilation airways; however, economics dictate that very deep mining operations fully utilize the production shaft for ventilation. These deep shafts normally employ an auxiliary conveyance instead of a manway to reduce resistance.

Using basic principles, the calculation of the friction factor for a production shaft is complicated. The commonly accepted procedure is to employ the method described by Bromilow, which is too lengthy to be included in this handbook, but may be found in published reference literature¹. A subsequent technical paper elaborates on Bromilow's procedure but does not include a sample calculation helpful for practical application². An easier method to determine the friction factor of a proposed production shaft is to use ratio and proportion from the measured resistance of a similar existing shaft. To complete this procedure, assumptions are made as to the portions of the total resistance of the shaft. In a typical calculation where the shaft diameters and set spacing are similar, the known resistance of the existing shaft may be divided as follows.

- 25% to the wetted perimeter of the shaft wall (divided by the total area)
- 50% to the area of the top of the sets facing the air stream (divided by the total area)

- 10% to the area of the top of conveyances (deep shaft and typical conveyances assumed)
- 15% to shock loss at entry and exit (deep shaft assumed).

Example

Find the equivalent friction factor, k , of a proposed production shaft by ratio and proportion to an existing shaft that has a k value measured at 125.

- Facts:
1. The proposed shaft is 24 feet in diameter, has a top face area of sets of 40 square feet, a top area of conveyances of 160 square feet, a depth of 6,000 feet, a set spacing of 20 feet and is moderately well designed for airflow at entry and exit.
 2. The reference shaft is 26 feet in diameter, has a top face area of sets of 48 square feet, a top area of conveyances of 180 square feet, a depth of 4,500 feet, a set spacing of 18 feet and is moderately well designed for airflow at entry and exit.

Solution: $k = 125[(0.25 \times 1) + 0.5 (40 \times 18 \times 13 \times 13 / 48 \times 20 \times 12 \times 12) + 0.1(160 \times 13 \times 13 \times 4500 / 180 \times 12 \times 12 \times 6000) + 0.15 \times 4500 / 6000] = 31.3 + 55.0 + 9.8 + 14.1 \approx 110$

In deep shafts, the sets (buntions and dividers) are the culprits responsible for most of the resistance, which is one reason that shaft designers want the set spacing to be as far apart as practical. Increasing the set spacing from 5m to 6m (16½ feet to 20 feet) reduces the friction factor of the sets by approximately 8% and the shaft by about 4%. This small advantage is lost if the size of the buntions must be increased to accommodate the wider spacing.

A better opportunity to lower resistance is to use buntions that have a small drag coefficient. For this purpose, some shafts were equipped with fabricated diamond-shaped buntions. These are no longer employed, mainly because of the high fabrication cost. Today, deep shafts are invariably equipped with sets made of cold rolled rectangular sections (HSS), which are structurally stronger for their weight and relatively efficient with respect to drag. Figure 18-1 illustrates the drag coefficients.

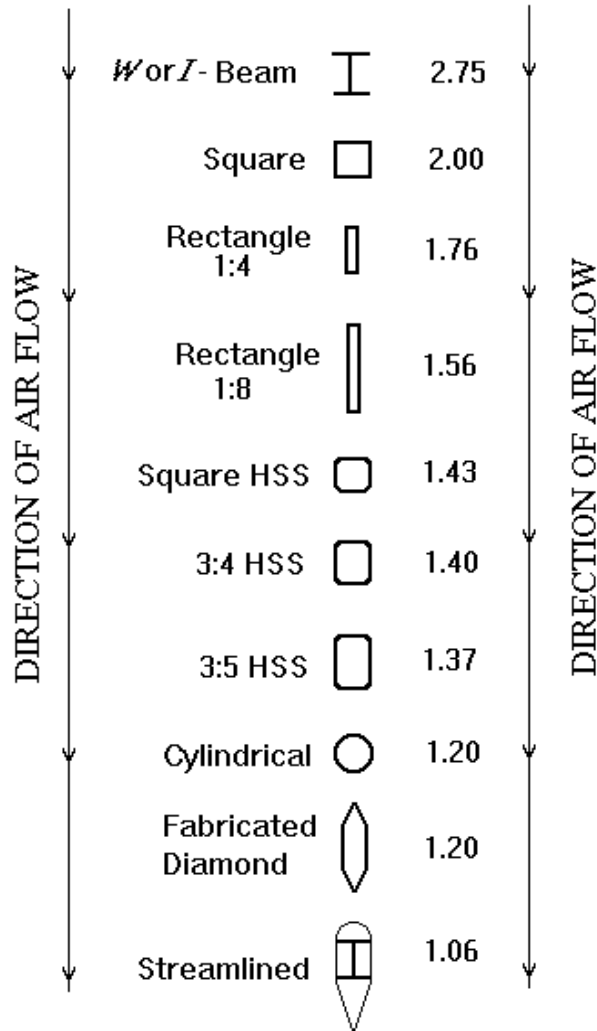

Figure 18-1 Drag Coefficients

By conventional wisdom, vertical installations in the shaft (guide ropes, electric cables, and pipes) ought to increase the shaft resistance because they increase the rubbing surface and slightly decrease the cross sectional area of the airway. However, they may be ignored when calculating the resistance of a proposed production shaft. This is because wind tunnel tests carried out in Germany³ demonstrated the opposite effect: When measured in a wind tunnel, thin steel rods inserted longitudinally in a shaft model produced *less* resistance (as much as 13%). This phenomenon, discovered by S. Bär, is long forgotten, but should be revisited. If it is significant, discarded hoist rope suspended in an open ventilation shaft or raise could reduce resistance and hence power costs, for example. The flanged connections in a pump column remain a detriment to shaft resistance. Wherever practical, high strength grooved mechanical “low-profile” couplings should be used instead.

¹Bromilow, John, *The Estimation and the Reduction of Aerodynamic Resistance of Mineshafts*, IME Transactions, London, Vol. 119, Part 8, 1960

²McPherson, M.J., *An Analysis of the Resistance and Airflow Characteristics of Mineshafts*, Fourth International Ventilation Congress, Brisbane, July 1988.

³Bär, S., *Der Wetterwiderstand von Förderschächten und die Möglichkeiten zu seiner Verringerung, Nach Modellversuchen*, Glückauf, 1949, 85, 327

Ventilation Velocity Case History

Table 18-4 shows the tabulation of ventilation velocities reported for actual hoisting shafts equipped with steel sets.

Table 18-4 Case Histories
(Velocities exceeding 9m/s)
Circular Concrete Shafts Equipped with Steel Sets
(Hoisting Shafts)

Location	Mine	Shaft	Diameter		Q		Air Velocity	
			m	feet	m ³ /s	cfm	m/s	fpm
RSA	Vaal Reefs	No.2	7.9	26	458	970,000	9.3	1,827
RSA	Pres Brand	No.3	7.3	24	500	1,060,000	11.9	2,343
RSA	Pres Brand	No.5	7.3	24	500	1,060,000	11.9	2,343
RSA	West Deeps	No.3	7.9	26	448	950,000	9.1	1,789
Canada	Ojibway	Access	3.7	12	118	250,000	11.2	2,210
Canada	Williams	Production	7.9	26	472	1,000,000	9.6	1,883
Canada	Potacan	Production	4.9	16	231	490,000	12.4	2,437
Canada	Potacan	Service	4.9	16	231	490,000	12.4	2,437
Canada	Kidd Creek	No.1	7.3	24	467	989,000	11.1	2,186
USA	Texas Gulf	Green River	4.9	16	260	550,000	13.9	2,735
USA	Occidental	Service	10.4	34	944	2,000,000	11.2	2,203
USA	Barrick	Meikle*	5.5	18	295	625,000	12.5	2,456

* The capacity figure shown for this shaft is taken from published literature that may be outdated.

18.10 Ventilation Duct Design

Ventilation ducts are required for advancing most development headings, including shafts, drifts, and ramps. (Raise drives are normally ventilated with compressed air.) The two common types of ventilation duct are metal tubing ("hard line") and fabric tubing ("bag"). Bag duct is only suitable for forced ventilation unless it is reinforced with spiral wiring that greatly increases its resistance. Ducts are normally circular in cross section; however, in special circumstances, oval or rectangular ducts are employed and these may be constructed of fiberglass, metal, or even concrete. These ducts may be sized for preliminary approximations on the basis of velocity. Table 18-5 provides calculated diameters required for ventilation ducts at different quantities of airflow for typical maximum design velocities. The nearest larger standard sized ventilation duct (i.e. 18, 24, 36, 48, 60, 72 inches) may be selected from the diameters shown in the tables for practical application.

Table 18-5 Ventilation Duct Diameters

	Type of Ventilation Duct			
	Hard Line (plastic/f-glass)	Hard Line (metal)	Smooth Bag (plastic fabric)	Spiral Bag (plastic fabric)
Typical Resistance (K factor)	13	15	20	60
Maximum Design Velocity (fpm)	4,000	3,750	3,350	2,250
Airflow (cfm)	Minimum Duct Diameter (inches)			
5,000	15	16	17	20
10,000	21	22	23	28
15,000	26	27	29	34
20,000	30	31	33	40
40,000	43	44	47	56
50,000	48	49	52	62
75,000	59	61	64	78
100,000	68	70	74	90

18.11 Selection of Electric Powered Ventilation Fans

Fans are first designed by determining the total pressure needed (H_t) to deliver the required quantity of air (Q). H_t is the sum of the static pressure and the velocity pressure.

$$H_t = H_s + H_v$$

or

$$TP = SP + VP$$

The velocity pressure may be ignored when designing main fans because they normally incorporate a well-designed inlet/outlet. Velocity pressure is always ignored in the case of an in-line booster fan on a hard line duct; however, the velocity pressure is normally considered in the case of a single fan installation for primary development or shaft sinking because the duct outlet is abrupt.

Example

Find the approximate fan design pressure and fan horsepower required for sinking a circular concrete ventilation shaft.

- Facts:
1. The circular concrete ventilation shaft is 18 feet in diameter
 2. The shaft will be sunk to a depth of 800 feet
 3. The desired velocity of the return air is 50 fpm
 4. The friction of return air in the shaft is negligible
 5. Bag duct ($k = 20 \times 10^{-10}$) is employed

- Solution:
1. The quantity of air required is $Q = VA = 50\pi \times 9 \times 9 = 12,723$ cfm
 2. To this 10% is added to account for leaks: $12,723 \times 1.1 = 14,000$ cfm
 3. A duct size of 28 inches is first selected by interpolation from the table above
 4. The nearest larger standard duct size of 30 inches is selected in this case
 5. $SP = kPLQ^2/5.2A^3 = 20 \times 2.5\pi \times 800 \times (0.14)^2/5.2 \times (1.25\pi \times 1.25)^3 = 4.0$ inches
 6. $VP = (V/4000)^2 = (Q/4,000A)^2 = 14,000/4,000 \times \pi \times 1.25 \times 1.25 = 0.7$ inches
 7. $TP = SP + VP = 4.0 + 0.7 = 4.7$ inches
 8. The air HP = $TP \times Q/6350 = 4.7 \times 14,000/6350 = 10.4$ HP

In the absence of manufacturer's fan curves, it may be assumed that a fan for this service equipped with a silencer will have an efficiency of approximately 70%. A 15 HP vane-axial fan will likely be satisfactory.

18.12 Air Fans

Fans that are run by compressed air are often employed for small exploration or development headings where it is not practical to provide electrical power. These fans may be purchased in various sizes up to 24 inches in diameter; however, the most common size is 12 inches. This fan consumes approximately 75 cfm of compressed air and will provide approximately the airflow shown in Table 18-6.

Table 18-6 Air Fan Airflow

H_t (inches water gage)	2	3	4	5	6	7
Airflow, Q (cfm)	3,900	3,400	2,900	2,400	1,900	1,000

18.13 Testing Ventilation Fan Performance

The best place to measure a fan's flow is just upstream where the area of the cross-section is well defined and the airflow is less turbulent. The fan manufacturer usually provides suitable openings for inserting a Pitot tube. Twenty readings are commonly taken, five in each quadrant. The depth of the readings provides equal areas covered within the inlet, so that a simple arithmetical average provides a reliable value. The air velocity may then be determined from the average pressure by the following formula.

$$V = 1,100 (VP/\gamma)^{1/2}$$

- In which, V = velocity (feet/minute)
 VP = average pressure (inches water gage)
 γ = air density (Lbs./cubic foot)

Example

Find the air stream velocity (V), and flow (Q), at the following fan installation.

- Facts: 1. The average of velocity pressure (VP) measurements is 1.00 inches water gage
 2. The ambient air density is 0.0757 Lbs./cubic foot
 3. The diameter of the inlet duct is 4 feet

- Solution: 1. $V = 1,100 \times (1/0.0757)^{1/2} = 4,000$ fpm
 2. $Q = VA = V \times \pi R^2 = 4\pi R^2 V = 50,000$ cfm

18.14 Threshold Limit Value

The threshold limit value (TLV) is the maximum safe concentration of a noxious gas or dust in the atmosphere underground. A SF is included in each TLV value. The SF varies from 10:1 for lethal gases, such as carbon monoxide (CO) to as low as 1½:1 for irritants, such as ammonia (NH₃). Only about one half of the total airborne dust is respirable. Gaseous contaminants are measured in ppm (volume) and respirable dusts are measured in mg/m³ (milligrams per cubic meter). Examples with typical values are provided in the Table 18-7. More complete and accurate information on TLVs and Time Weighted Averages (TWAs) can be found in the *Threshold Limit Values and Biological Exposure Indices*, 1999, produced by the American Conference of Governmental Industrial Hygienists, Cincinnati, USA.

Table 18-7 Typical TLV's for Contaminants and Respirable Dusts

Contaminant	CO ₂	CO	SO ₂	NO _x	NH ₃	Limestone Dust	50% Silica Dust
TLV	5,000 ppm	50 ppm	5 ppm		25 ppm	5mg/m ³	0.2 mg/m ³

In Arctic mining operations, wet drilling underground is a problem because of permafrost. One base metal mine has been able to drill dry (with dust collectors) because the host rock is limestone; however, most hard rock mines have high silica content in the ore. Dust collectors are inadequate in this case, mainly because the TLV is in the order of 10 times more stringent. The same problem arises when road headers are employed in hard rock mines.

Example¹

Determine the approximate ventilation air capacity (Q) required for a diesel engine underground.

- Facts: 1. The underground diesel engine consumes fuel at a rate of 0.45 Lbs./HP hour.
 2. The sulfur content of the fuel is ½%.
 3. The efficiency of dilution is 90%.
 4. The ventilation air weighs 0.074 Lbs./cubic foot.
 5. The entire sulfur content converted to sulfur dioxide (SO₂), which is 2.25 times as dense as air.
 6. The TLV for SO₂ is 5 ppm.

- Solution: 1. In one hour the engine will burn 0.45 x 0.005 = 0.00225 Lb. of sulfur (MW = 32) to produce 2 x 0.00225 = 0.0045 Lb. of sulfur dioxide (MW = 64) for each horsepower.
 2. The weight of air required for dilution to 5 ppm at 90% efficiency is
 (0.0045 x 1,000,000)/(5 x 0.90 x 2.25) = 444 Lbs.
 3. The ventilation required = 444/(0.074 x 60) = 100 cfm/HP (cfm per horsepower)

¹ The solution presented for this example is based on simplification of the actual combustion process and hence may not be precisely accurate.

18.15 Diesel Particulate Matter

As pointed out in the introduction, dealing with the problem of respirable DPM is a problem that has recently become a prime focus of attention by regulators and operators. The emissions from diesel engines produce minute solid particles (DPM) due to incomplete combustion and impurities in the fuel. This matter consists of impregnated carbon and a variety of organic compounds, such as paraffin (wax), aldehydes, and polynuclear aromatic hydrocarbons. Some of these compounds are recognized carcinogens. Unfortunately, the standard catalytic scrubber (oxidation catalytic converter) is not efficient at removal of these particulates and moreover the particulates do not remain uniformly diffused in the exhaust air of the mine (they are subject to stratification).

The TLVs discussed in the previous section dealt in part with rock dusts that were measured in milligrams per cubic meter. DPMs are measured in micrograms per cubic meter. (One milligram = 1,000 micrograms.)

The most suitable instruments and correct sampling procedures for DPMs remain items of controversy, but in general terms, it may be said that the traditional emissions encountered in trackless hard rock mines averages approximately 700 micrograms/m³. Proposed legislation in the USA (MSHA) sets a concentration limit of 400-micrograms/ m³ after an 18-month initiation period. After five years, the limit would be lowered to 160 micrograms per m³.

These limits represent a serious problem for mine operators. Some mining associations and individual operators are actively protesting the proposed regulations as well as the severity of the new limits – with sound arguments. Among other objections, it is pointed out that there is no scientific documentation that exposure to the current levels of diesel emissions is sufficiently dangerous to cause miners to “suffer material impairment of health or physical capacity.” At the same time, a number of larger mining companies in the USA and Canada are proactively engaged in and/or privately funding research aimed at lowering the present level of emissions. The reader desiring additional information may refer to articles found at the MSHA web site (www.msha.gov/), and a number of technical papers contained in the Proceedings of the 6th and 7th International Mine Ventilation Congresses.

Following is a list of remedies that have been contemplated in anticipation of proposed new regulations.

- Electronic ignition (usually provided on new LHD equipment purchases) to improve combustion efficiency.
- Exhaust filters (sintered metal or ceramic based exhaust after-treatment devices).
- Fuel borne catalyst (as opposed to an exhaust-based catalyst) to improve combustion efficiency.
- Very low sulfur diesel fuel (reduces sulfite particulates). Regular diesel fuel sold in North America today by the major oil companies is extremely low in both sulfur and paraffin content.
- “Biodiesel” fuel derived from vegetable oils (approximately three times as expensive as ordinary diesel fuel).
- Engine replacement at 4,000 hours of service (expensive).
- Increase mine ventilation capacity (often not practical for an existing mine and very expensive for a new mine).
- Ban smoking in hard rock mines (after-smoke is detected as DPM).
- Eliminate rock drill oil for hand-held pneumatic drills and replace with semi-solid grease (oil mist may be detected as DPM). This remedy is already implemented at a number of hard rock mines for this and other reasons.
- Dust masks, respirators, etc. for miners.

18.16 Heat Generated by the Auto-Compression of Air

When air descends in a mineshaft, it is heated by auto-compression. The potential energy possessed by the air at the top of the shaft is converted into heat energy by the time the air reaches the shaft bottom.

The increase in heat content due to auto-compression of 1 kg of air passing down a duct or dry shaft/raise may be calculated using the following formula (C_{pa} is the heat capacity of air in kJ / kg ·°C).

$$\Delta Q = \frac{\text{gravitational acceleration} \times \text{mass} \times \text{distance}}{1000}$$

$$\Delta Q = 9.79 \times 1 \times \frac{100}{1000} = 0.979 \text{ kJ/kg}$$

The increase in dry bulb temperature = $\Delta Q/C_{pa} = 0.981/1.02 = 0.96^\circ\text{C}$. This value corresponds closely to the rule of thumb that states that the dry bulb temperature will rise by one degree C. for each 100m that air descends in a ventilation airway. The wet bulb temperature (determined from a psychometric chart) will rise by approximately half this amount (assuming no transfer of moisture from the shaft wall to the air stream).

Burrows, Hemp, Lancaster & Quilliam, *The Ventilation of South African Gold Mines*, Cape & Transvaal Printers Ltd., Cape Town, 1974.

18.17 Ventilation Management in the Operating Mine

The following “rules” were provided courtesy of Allan Hall.

- Only one person should have control of the mine ventilation system. No fan, regulator, door, or stopping should be installed, removed or have its settings changed without the approval of the responsible person.
- No airflow should be deliberately changed significantly in quantity or direction without the approval of the responsible person.
- Competent ventilation supervision and control is impossible without accurate instruments and measurements. It cannot be achieved without going underground.
- The principal requirement is an accurate plan of the airflows, fans, stoppings, doors and regulators in the mine. The airflows must be checked and the pressures across fans, doors and seals must be measured and updated on a regular basis and after changes are made to the system.
- Ensure that all fans are essential to the whole ventilation system and are not working against other fans in a multi-fan system.
- Keep dust and gas out of mine intakes and intake airways. Try and prevent dust and gas at source.
- Use a pressure – quantity plot to determine any anomalies in the system resistance, excessive power usage in booster fans and regulators and leakage problems.
- Keep intake airways dry, especially in hot mines and mines liable to fogging. Keep falling water out of shafts and main airways.
- Canaries and open flames (candles) are not accurate gas or oxygen deficiency indicators, but are much more reliable than UNCALIBRATED electronic sensors.

18.18 The Required Capacity of a Mine Air Heater

In cold climates, it is usually required to heat the ventilation air above the freeze point, otherwise ground water seeping into the ventilation entry will freeze. (In some cases, the ice build-up has been sufficient to eventually choke the airway.)

Certain mines have been successful in avoiding this requirement. For example, providing internal water rings in concrete lined shafts and raises will keep them watertight.

Most mining operations in temperate climates are required to heat the ventilation air during the winter with heaters using natural gas, propane, diesel fuel, or electricity. For this purpose, off-the-shelf mine air heaters may be purchased for development projects or small mining operations. Larger installations usually require custom-built heaters. In either event, an initial requirement exists to determine the capacity of the heater required (typically measured in Btu/hour). For this purpose, the following simple formula may be applied to obtain the value in Btu/hour units (1 kW =3,412 Btu/hour).

$$Q = 1.08 \times \Delta T \times \text{cfm}$$

[The formula is based on standard air density (0.075 Lbs./cubic foot). Where this is significantly different from the actual density of the air at the mine's location, the formula should be extended to account for this (multiply result by local density/0.075)]

Example

Find the heater capacity required to raise the air temperature of ventilation air from -40°F to $+40^\circ\text{F}$ at standard air density.

Fact: There is 100,000 cfm of ventilation air.

Solution: $Q = 1.08 \times 80 \times 100,000 = 8,640,000 \text{ Btu}$

Note

Despite the fact that the humidity of the air is not accounted for in this procedure, the result is accurate because at a temperature of -40°F the moisture content of air is virtually zero, even if it is saturated.

18.19 Heat Load

Miners working in a hot environment may sweat two to three gallons of water in a shift. To help avoid heat stress, this water should be replaced with cool drinking water. Taking salt tablets is no longer believed beneficial. Most miners retain enough salt if they put a little extra in their diet. At least one mine in the USA and one in Canada provides *Gatorade*® for their miners to help restore electrolytic balance.

The natural rock temperature near surface of an underground mine is equal to the mean annual temperature on surface. The rock temperature rises about 1 degree F. for each 100 feet of depth; however, in hard rock mines, the gradient will vary as much as 50% higher or lower depending on the conductivity of the earth's crust at the mine location (exceptions exist). Ventilation alone may not be sufficient to remove the heat generated from freshly broken rock and new faces when the natural rock temperature reaches approximately 95 degrees F. To determine the amount of additional cooling necessary for a particular mine, a heat balance calculation is often made. Table 18-8 shows a typical example.

Table 18-8 Heat Balance

Origin	Description	Heat Loading (BTU/min)	Heat Removal (BTU/min)
Rock	Broken rock and wall rock	370,000	
Ventilation	Skin friction and shock losses	60,000	
Ventilation	Auto-compression	20,000	
Diesel engines	Mobile Equipment	40,000	
Electric	Motor and cable losses	20,000	
Electric	Lighting	1,000	
Explosives	Heat of detonation	4,000	
Ground water	Seepage	3,000	
Backfill	Hydration of cement	2,000	
Personnel	Metabolism	1,000	
Dewatering	Hot water pumped to surface		30,000
Service Water	(not chilled)		40,000
Compressed air	Expansion		25,000
Ventilation air	(not chilled)		320,000
Refrigeration required	(to service water and ventilation)		106,000
TOTALS		521,000	521,000

The tabulation indicates a refrigeration requirement of 106,000 Btu/minute, which is equal to $106,000/200 = 530$ TR.

For a proposed mine, most of the quantities in the above table can be calculated with accuracy. One exception is determining the heat from the rock, which may include heat from oxidation of broken ore. Unfortunately, this is the major contributor to the heat load. Because the calculated quantity of refrigeration is obtained by difference, the inaccuracy of the heat load will be magnified in the figure obtained for the required quantity of refrigeration. Perhaps a better method is to identify one or two comparable mines and determine the refrigeration capacity required by ratio and proportion. It should be noted that the design basis for most North American mines has been 75 degrees (wet bulb) in the stope. In Europe, it is 80 degrees F. and the design basis is even higher in South Africa.

18.20 Cooling

Various types of cooling devices are employed for underground workings ranging from a simple atmospheric cooler ("swampy") to a mechanical refrigeration plant that produces ice on surface for delivery underground (usually in the service water). As a general rule, the deeper the mine workings, the more sophisticated the cooling plant.

Because mechanical refrigeration is very expensive, it is considered the method of last resort and every effort is expended in mine planning to avoid it or reduce its requirements. Following are some of the methods employed.

- Increase the mine primary ventilation capacity (from surface).
- Increase the mine ventilation capacity underground with controlled recirculation to increase velocity and capacity.
- Route intake air through old workings near surface (including “ice stopes”).
- Reduce the amount of broken ore left underground in stopes and bins.
- Convert diesel powered trackless equipment to electric.
- Conduct heat tolerance testing for work applicants.
- Provide a five-day acclimatization schedule for new hires.
- Provide slightly saline (0.1%) drinking water for the miners.
- Convince miners to drink more water than required to slake thirst.
- Provide ice vests for the miners.
- Provide air-conditioned lunch/refuge rooms for rest breaks.
- Replace ditches with sealed pipes.
- Seal off old workings.
- Provide air-conditioned cabs for equipment operators.
- Provide remote stations for equipment operators.
- Increase the compressed air capacity of the mine (and provide “air movers”).
- Work short shifts underground.
- Hire miners from tropical climates.

Each of these procedures is beneficial, but only the first three are of major significance. The third is limited in application to those mines with suitable old workings.

Increase the Mine Ventilation Capacity

Increasing the volume of ventilation air for a deep hot mine is only significant if it increases the velocity of air in the workings. There is a marked improvement in the comfort and work efficiency of the miners with increase in velocity, as shown in Table 18-9.

Table 18-9 Mine Ventilation Capacity

Velocity of Ventilation Air	Maximum Desirable Wet-Bulb Temperature ¹
50 fpm	75 ^o F
100 fpm	81 ^o F
200 fpm	84 ^o F
300 fpm	85 ^o F

¹Relative values based on approximately equal comfort and work efficiency.

An economical limit exists to the size of air entries and development headings to accommodate high air volumes. The economical limit seems to correspond to a maximum practical ventilation rate of approximately 250 cfm per ton of ore and waste rock broken per day (refer to Table 18-10 at the end of this chapter). For an operating mine going deeper into hot ground, it can be an extraordinary expense to provide new ventilation entries. One solution is to re-circulate a portion of the underground air, passing it through filters and scrubbers. This procedure was first employed with success at Butte, Montana and later at the Homestake mine in South Dakota.

Route Intake Air through Old Workings Near Surface

Drawing the fresh air through old workings, pit rubble, or caved workings has proven the most successful way of avoiding mechanical refrigeration in temperate climates. For example, this method is applied at deep mines in the Sudbury, Timmins, Leaf Rapids, and Red Lake mining areas of Canada with success. Not only does it provide cooling year around, but also the requirement (and expense) of heating the fresh air during the cold winter months is avoided. (The procedure is also employed in Wyoming, but mainly to avoid heating air in winter.)

18.21 Mechanical Refrigeration

Refrigeration plants are distinct from simple cooling devices incorporating water sprays only. In many instances, only mechanical refrigeration can provide the necessary cooling power for a hot mine.

The heart of a refrigeration unit is a compressor that pressurizes and thus heats a suitable gas, such as ammonia. The hot compressed gas is then cooled with a water spray in a condenser until it becomes liquid. Subsequently, it is allowed to expand through a valve, which cools it and restores it to a gaseous state. The cold gas is used to cool ventilation air on surface and chill (or provide ice for) service water by means of a heat exchanger. The cold service water, sometimes containing ice particles (“frazil ice”), is sent underground for drill water, dust spray, and use in underground bulk coolers (water

spray) for localized air-cooling. Like air, water descending in a mine will lose potential energy and become warmer. In deep mines, the potential energy of the water is often recovered with a Pelton wheel generator.

In the past, primary mechanical refrigeration units were often installed underground. Today, refrigeration units are invariably installed on surface, for a number of reasons. One is that freons (CFC refrigerants) are no longer employed as the refrigerant gas in accordance with the Montreal Protocol. Alternative refrigerants, such as ammonia are a potential hazard underground. (It is reported that at one mine in South Africa this problem is to be overcome by locating an underground refrigeration plant that uses ammonia in the foot of an exhaust shaft.)

The capacity of a mechanical refrigeration plant is traditionally measured in tons. A ton of refrigeration will freeze one short ton of water at 32 degrees F. in 24 hours. This is equivalent to 200 BTU/minute or 3.157 kW.

Table 18-10 Case Histories of Deep Hot Mining Operations

Company	Mine	Unit	Location	Main Minerals	Scale Tonnes per day	Mining Average	Depth Deepest	Main Access	Ore Geom.	Dip or Plunge	Mining Method	Backfill Types	Primary Cooling	Refrigeration Capacity	Cooling per tonne/day of ore	Ventilation Capacity	cfm per tonne/day of ore	Status
Falco	Kidd Creek	No.3	Timmins	Zn Cu	3,400	1,900m	2075m	Winze	MS Lenses	78-90 ⁰	UC Blasthole	CRF	Pit Rubble	Nil		234 m ³ /s	146	Operating
INCO	Creighton	No. 9	Sudbury	Ni Cu	3,800	varies	2255m	Shaft	Intrusive	70 ⁰	Modified VRM	Paste	Caved Zone	Nil		381 kg/s	177	Operating
Hecla	Lucky Friday		Idaho	Ag Pb	1,000	1,80m	1900m	Shaft	Vein	85-90 ⁰	LW-UCF	Paste	Chill Water					Operating
Homestake	Lead	Deep	South Dakota	Au	3,700	1,850m	2600m	Winze	Pipe/Lens	70-80 ⁰	CAF	CSF	Bulk Air	10.9 Mw	2.95 kW/t/d	391 m ³ /s	223	Standby
Bharat	Kolar	Champion	India	Au	900	2,400m	2740m	Winze	Vein		Shrinkage	CTF	Bulk Air	4.0 Mw	4.44kw/t/d			Closing
JCI	WAGM	South Main	RSA	Au	5,400	2,100m	2600m	Winze	Reef	15-20 ⁰	Longwall	CTF	Chill Water					Operating
JCI/PD	WAGM	South Deep	RSA	Au	8,300	2,500m	2800m	Shaft	Reef	15-20 ⁰	CAF	Stiff*	Ice Slurry	85.0 Mw	10.2 kW/t/d	924 kg/s	195	Starting
AAC	Elandstrand	Deep	RSA	Au	6,000	2,600m	3533m	Winze	Reef	21 ⁰	Sequential Grid	CTF	Chill Water	42.0 Mw	7.0 kW/t/d	660 m ³ /s	232	Operating
Goldfields	Harmony		RSA	Au	5,000			Winze	Reef		Longwall	CTF	Plate Ice			690 m ³ /s	292	Operating
AAC	Western Deep	South	RSA	Au	6,190	3,300m	3700m	Winze	Reef		Sequential Grid	CTF	Vacuum Ice	75.0 Mw	12.1kw/t/d	700 m ³ /s	240	Operating
AAC	Val Reefs	South	RSA	Au	6,000			Winze	Reef	15-25 ⁰	Longwall	CTF	Chill Water	23.9 Mw	4.0 kW/t/d	720 m ³ /s	254	Operating
Morro Velho	Mina Grande	Belo Horizonte	Brazil	Au	500	2,189m	2475m	Winze	Vein	12-15 ⁰	CAF	Waste	Atmospheric	-	-	10.1 m ³ /s	43	Closed
Lepanto	F.S.E.	Deep	Philippines	Au	17,500	1,570m	1700m	Shaft	Plug	N/A	Blasthole	Paste	Ice slurry	72.0 Mw	4.1 kW/t/d	1321m ³ /s	160	Planning

19.0 Compressed Air

19.1 Introduction

This section is devoted to “7 bar” compressed air systems for mine application and does not deal with low-pressure (0.5 -2 bar) compressed air supplied by “blowers” in the mill for flotation cells or process tanks.

Compressed Air Inefficiency

A compressed air system is the traditional means used to supply energy for underground mining equipment. Converting electrical power into mechanical power by compressing air is the most expensive and least efficient utility in the mining industry. The actual efficiency may be near 20% compared to approximately 40% for diesel engines and 95% for electric motors. Because air has no smell or color, leaks are not readily detected and a large amount of compressor capacity is lost through waste and neglect. The efficiency of compressed air distribution systems is made worse because mines do not normally dry air beyond removing precipitation from primary cooling at the source. The air leaving a compressor is typically in the order of 275^o F (135^o C). The after cooler lowers it to approximately 105^o F (40^o C), at which point it is 100% saturated. The result of the cooling is to precipitate approximately 2/3 of the moisture contained in the air stream. This water is normally automatically removed from a separator at the after cooler and a surface receiver removes more. Unless the mine air is very warm, further cooling will take place underground precipitating water so rust develops on the inside walls of pipe lines, which eventually increases the resistance to the compressed air flow. The increased friction and rust build-up as a result of corrosion is one reason that underground mines experience a gradual decrease in air pressure over a prolonged period of time. After a number of years, the corrosion will progress to the point that steel pipelines require replacement. When compressed air travels downward into the mine (shaft column), it experiences warming due to auto-compression, but this is normally insufficient to prevent precipitation.

When the compressed air reaches its final destination, it expands and cools rapidly often resulting in icing that can completely freeze an underground machine. Another problem is noise, particularly noise produced from the exhaust ports of drilling equipment. The noise level for a jackleg drill operator is approximately 110 decibels, and for a jumbo operator (further away from the drill) the level is near 100. Hearing damage is believed most likely to occur at noise levels above 85 decibels between 1,200 Hz and 4,800Hz. In this frequency range, earplugs will lower the noise level to the ear of the operator by about 25 decibels and earmuffs by about 40. Hearing protection is less effective at lower frequencies.

Compressed Air Replacement

The introduction of hydraulic drills, replacement of slushers with LHD units, and advent of on-board compressors for mobile equipment have decreased the requirements for a compressed air circuit underground. A few mines (particularly in arctic regions) have completely eliminated the requirement for a stationary compressed air plant on surface. One mine in South Africa, Northair Platinum, has replaced compressed air with water from a shaft column. The drills are designed to run on hydropower instead of compressed air or hydraulic oil.

Most operating mines still find that a compressed air reticulation system in the mine is necessary. It is found useful for blowing muck; operating hand held drills and shop equipment, dislodging hang-ups, clearing pipelines, dispersing sediment, applying shotcrete, cleaning equipment, spot cooling, air lifts, diffusing stench gas, connection to refuge stations, and ventilating raise headings.

Compressor Capacity

Compressor capacity is expressed in terms of the volumetric rate of inlet air processed. Capacity refers to performance at sea level at a specified compression ratio or outlet pressure.

In imperial units, the outlet pressure of the compressed air is expressed in pounds per square inch over the atmospheric pressure (psi or psig). In metric terms, the pressure is correctly expressed in bars or kilopascals (kPa). A bar was once equivalent to standard atmospheric pressure (1.03 kg/cm² or 14.7 psi). Today, it is defined as being equal to 100 kilopascals.

$$1 \text{ bar} = 1.02 \text{ kg/cm}^2 = 14.50 \text{ psi} = 100 \text{ kPa}$$

In empirical terms, the capacity is expressed in cfm. In metric terms, it may be expressed in liters per second (l/s) or cubic meters per minute (m³/min).

$$1 \text{ m}^3/\text{min} = 16.7 \text{ l/s} = 35.3 \text{ cfm}$$

$$1 \text{ l/s} = 2.12 \text{ cfm}$$

Rules of Thumb

As a result of the decreasing requirement underground, certain traditional rules of thumb related to the required compressor plant capacity are no longer valid; therefore, these are not included in the list that follows.

19.2 Rules of Thumb

Power

- The horsepower required for a stationary single-stage electric compressor is approximately 28% that of its capacity, expressed in cfm (sea level at 125 psig). *Source:* Lyman Scheel
- The horsepower required for a portable diesel air compressor is approximately 33% that of its capacity, expressed in cfm (sea level at 125 psig). *Source:* Franklin Matthias
- To increase the output pressure of a two-stage compressor from 100 to 120 psig requires a 10% increase in horsepower (1% for each 2 psig). *Source:* Ingersoll-Rand

Air Intake

- The area of the intake duct should be not less than ½ the area of the low-pressure cylinder of a two-stage reciprocating compressor. *Source:* Lewis and Clark

Cooling

- A series flow of 2.5 to 2.8 USGPM of cooling water is recommended per 100 CFM of compressor capacity for the typical two-stage mine air compressor (jackets and intercooler). *Source:* Compressed Air and Gas Institute (CAGI)
- A parallel flow of 1.25 USGPM of cooling water is recommended per 100 CFM of compressor capacity for the aftercooler of a typical two-stage mine air compressor. *Source:* CAGI
- Approximately 2½% of the cooling water will be lost due to evaporation with each cycle through a cooling tower. *Source:* Jack de la Vergne

Receiver

- The primary receiver capacity should be six times the compressor capacity per second of free air for automatic valve unloading. *Source:* Atlas Copco
- The difference between automatic valve unloading and loading pressure limits should not be less than 0.4 bar. *Source:* Atlas Copco

Air Line Losses

- At 100 psi, a 6-inch diameter airline will carry 3,000 cfm one mile with a loss of approximately 12 psi. *Source:* Franklin Matthias
 - At 100 psi, a 4-inch diameter airline will carry 1,000 cfm one mile with a loss of approximately 12 psi. *Source:* Franklin Matthias
 - A line leak or cracked valve with an opening equivalent to 1/8-inch (3mm) diameter will leak 25 cfm (42m³/min.) at 100 psig (7 bars). *Source:* Lanny Pasternack
 - In a well-managed system, the air leaks should not exceed 15% of productive consumption. *Source:* Lanny Pasternack
 - Many older mines waste as much as 70% of their compressed air capacity through leakage. *Source:* Robert McKellar
 - Drilling requires a 25-psi air-drop across the bit for cooling to which must be added the circulation loss for bailing of cuttings in the borehole at a velocity of 5,000 fpm, or more. *Source:* Reed Tool
 - Except in South Africa, pneumatic drills are usually designed to operate at 90 psig (6.2 bars). Their drilling speed will be reduced by 30% at 70 psig (4.8 bars). *Source:* Christopher Bise
 - A line oiler reduces the air pressure by 5 psi. *Source:* Ingersoll-Rand
 - An exhaust muffler can increase the required air pressure by 5 psi, or more. *Source:* Morris Medd
 - A constant speed compressor designed to be fed at 60 cycles (hertz) will operate at 50 cycles, but experience a reduction in capacity of about 17%. *Source:* Jack de la Vergne
-

Altitude

- A constant speed compressor (or booster) underground will require 1% more horsepower for every 100m of depth below sea level. *Source: Atlas Copco*
 - Auto-compression will increase the gage pressure of a column of air in a mineshaft by approximately 10% for each 3,000 feet of depth (11% for each 1,000m). *Source: Jack de la Vergne*
 - The compressed air from a constant speed compressor will have 1% less capacity to do useful work for every 100m above sea level that it is located. *Source: Atlas Copco*
-

19.3 Tricks of the Trade

- A common misinterpretation of compressor capacity is to assume it refers to the outlet volume; in fact, it always refers to the inlet of ambient air. *Source: Ingersoll Rand*
- To maximize precipitation in a primary receiver, it should be placed in a cool location, but not outside in winter if the ambient air temperature falls much below freezing. *Source: Jack de la Vergne*
- A needle gauge (with spare needles) is an indispensable tool for determining pressure in a hose at the machine end. *Source: Henry Lavigne*
- "Air-less" mines are well served with skid-mounted portable compressors that can be towed as required around the workings by any unit of mobile equipment. *Source: Tony Keene*
- Its usually almost impossible to properly seal the bulkhead on a blind drift used to provide a large receiver underground. *Source: Jim Redpath*
- At altitudes less than 13,000 feet (4,000m), the textbook reduction factors for the capacity of an electric motor driving an air compressor may usually be ignored provided the motor has sufficient cooling. *Source: George Greer*
- Icing up of a unit of underground equipment can be avoided with a de-mister attachment or the application of tanner gas to the compressed air distribution lines. *Source: Rudy Warren*
- Employing plastic (instead of steel) pipe for distribution on mine levels can avert line pressure losses due to friction from corrosion inside the pipe. *Source: Jim Tilley*
- Line pressure losses due to shock can be diminished by the insertion of reducers at T and Y connections. *Source: Khoa Mai*
- Turbulent flow (as opposed to laminar or mixed flow) should be assumed when calculating line losses for a compressed air line at a mine. *Source: Andy Pitz*

19.4 Air Line Diameter

A myriad of methods exist to determine the diameter of an airline from simple rules of thumb to tables in handbooks to complicated formulae. The formulae are mainly derivations of D'Arcy's elementary formula (below), taking some account for the compressibility of air.

$$H = fLd^2/2g$$

The inside pipe diameter (d) required for a temporary installation (\pm one year) of new steel pipe or a permanent installation with a stainless steel or plastic pipe may be calculated by modifying the Weymouth formula to the following configuration.

$$d = \left[\frac{Q^2 \cdot L}{1736 \cdot (P_1^2 - P_2^2)} \right]^{0.188}$$

The pipe diameter (d) required for a permanent installation of new steel pipe or a hose length before the lubricator (oiler) attachment may be calculated by the Simons formula.

$$d = \left[\frac{Q^2 \cdot L}{2000 \cdot (P_1^2 - P_2^2)} \right]^{0.2}$$

In which, d = inside pipe diameter (inches)
 L = length of air line (feet)
 Q = Free air flow (cfm)
 P_1 and P_2 are the absolute pressures at the inlet and the outlet (psia)

Example

Determine the minimum inside pipe diameter required for a 10-psi drop.

- Facts:
1. $L = 5,800$ feet
 2. $Q = 10,000$ cfm
 3. Atmospheric pressure = 15 psia
 4. Inlet pressure = 110 psig, so $P_2 = (110 + 15) = 125$ psia
 5. Outlet pressure (10 psi drop), $P_1 = (125 - 10) = 115$ psia

- Solution:
1. For a temporary steel airline:
 $d = [10,000^2 \times 5800 / 1736 (125^2 - 115^2)]^{0.188} = 9.3$ inches
 2. For a permanent steel airline
 $d = [10,000^2 \times 5800 / 2000 (125^2 - 115^2)]^{0.2} = 10.4$ inches

(Refer to Table 20-8 in Chapter 20.11 for standard steel pipe dimensions.)

19.5 Air Lines Leaks

Older underground mines are plagued with air leaks. Actual measurements obtained by measuring the airflow at shutdown of underground operations at two mines produced the following results.

- At the first mine (30 years old), leakage consumed 52% of the installed compressor capacity.
- At the second (20 years old), leakage consumed 39% of installed compressor capacity.

At the second mine, 867 leaks were discovered of which 46% were involved grooved pipe mechanical couplings, 10% threaded pipe couplings, 23% faulty valves, 12% damaged hoses, and the remainder (9%) miscellaneous faults.

The leakage in all or any part of a pipeline network may be calculated by using the following process.

- Calculate the volume of air in the line or network to be tested
- Convert the volume to free air (atmospheric pressure)
- Fill the lines with air at normal operating pressure
- Close the lines at every end
- Time the fall in line pressure until it reaches zero
- Apply the Briggs formula: $Q = 5V/2t$

In which, Q = leakage in cfm
 V = volume of free air in the system
 t = the time in minutes from shutdown until the gage pressure reaches zero

A procedure has evolved to deal with leaks when they become intolerable. A dedicated team is assembled who may spend six weeks tracing the entire pipe network in the underground mine. Leaks are mended when discovered. Piping to blind ends is permanently capped. As the work progresses, the line pressure increases, which in some cases precipitates leaks in steel pipelines that must then be replaced. At some mines, it is not practical to have one repair crew working in different beats, so the non-staff members of the dedicated team are rotated as required.

Preventive measures against leaks include an employee awareness campaign and quality control over pipe alignment at couplings.

19.6 Air Receiver

The function of an air receiver is to provide surge capacity to the compressed air system. The consumption (demand) can exceed the compressor capacity for a short period of time, but eventually the line pressure will fall below the value necessary to run equipment properly.

The receiver capacity must first be enough to accommodate automatic unloading (when the demand falls) plus an operating allowance. Normally, this minimum value is first calculated and then increased to the next largest catalogued (off-the-shelf) model.

The following formula determines the minimum volume.

$$V = C P_1 / P$$

In which, V_m = Minimum Volume of Receiver (cubic feet)

C = Compressor Capacity (cfm)

P_1 = Compressor discharge pressure (psia)

P = Atmospheric pressure (psia)

Example

Determine the receiver capacity required for a 1,250 CFM compressor plant set for an outlet pressure of 105 psig at a location near sea level

- Facts:
1. $C = 1,250$ CFM
 2. $P = 15$ psia
 3. $P_1 = 105 + 15 = 120$ psia.

Solution: $V_m = 1250 \times 15 / 120 = 156$ cubic feet

The receiver capacity desired is the next largest standard size (probably 200 cubic feet).

19.7 Cooling Water

Most air compressor plants serving hard rock mines are water-cooled. In developing countries, it is common to dig a cooling pond for this purpose whereas cooling towers are typical in industrialized nations. An important design value necessary for a new plant installation is the amount of cooling water required. The typical two-stage compressor plant with intercooler and jacket cooled in series will require approximately 4 US gallons per minute per 100 CFM for the total plant, including the aftercooler. In temperate and arctic climates, the heat is sometimes recovered from the cooling water to heat mine air or surface buildings.

19.8 Equipment Air Requirements

Table 19-1 contains typical compressed air requirements for a selection of underground equipment. Refer to Table 19-2 for consumption data on additional equipment.

Table 19-1 Typical Compressed Air Requirements

Stoper	180 cfm
Jackleg drill	180 cfm
Sinker drill (plugger)	180 cfm
Jumbo drill	250 cfm
Air Alimak motor	93 cfm
Air or Elec Alimak (vent)	400 cfm
Blow Pipe, 2 inch	1,000 cfm
Air diamond drill	300 cfm
LM 250 Loader	600 cfm
Air Trac	900 cfm
Shotcrete machine	750 cfm
Top hammer drills, 2½"	250 cfm
Air mover (venturi)	40 cfm
Pneumatic rockbreaker	600 cfm
Air fan (12-inch)	75 cfm

19.9 Compressed Air Plant Capacity

The following methods may be employed to determine the plant capacity required for a proposed mine.

- Formula
- Averaging data from actual installations at comparable mines
- Detailed spreadsheet analysis

Example

Calculate the compressed air capacity required for a proposed underground mine by each of the three methods above.

- Facts:
1. The mine will be a trackless operation using diesel powered mobile equipment.
 2. The mine production rate will be 3,000 short tpd

Solution:

1. Formula

$$C = 140 T^{0.5} \quad (\text{O'Hara})$$

T = Short tons of ore mined daily (3,000)

C = New plant capacity in cfm

$$C = 140 \times (3,000)^{0.5} = 140 \times 55 = 7,700 \text{ cfm}$$

2. Comparable Mine Installations

Birchtree	2,300 tpd	7,000 cfm	3.04 cfm/ton
Bousquet No. 2	2,500 tpd	9,000 cfm	3.60 cfm/ton
David Bell	1,400 tpd	4,000 cfm	2.86 cfm/ton
Gaspé Copper	1,650 tpd	5,200 cfm	3.15 cfm/ton
Golden Giant	3,310 tpd	16,000 cfm	4.83 cfm/ton
Holloway	1,380 tpd	4,500 cfm	3.26 cfm/ton
Meston	1,200 tpd	4,400 cfm	3.67 cfm/ton
Nanisivik	2,425 tpd	8,400 cfm	3.46 cfm/ton
Niobec	2,500 tpd	5,900 cfm	2.36 cfm/ton
Ruttan	2,400 tpd	6,000 cfm	2.50 cfm/ton
<u>Williams</u>	<u>6,615 tpd</u>	<u>20,000 cfm</u>	<u>3.02 cfm/ton</u>
Average	2,516 tpd	8,218 cfm	3.266 cfm/ton x 3,000 = 9,800 cfm

3. Detailed Spreadsheet Analysis

The spreadsheet lists each item of equipment along with its nominal air consumption. The consumption figure is then rationalized to account for operating hours and utilization. A spreadsheet for this example and the resulting solution (8,000 cfm) are found in Table 19-2.

Of the three solutions obtained (7,700, 9,800, 8,000), the middle one is approximately 25% higher than the other two. This may be expected since the value was derived mainly from installations at older mines. In this case, a plant capacity of 8,000 cfm would likely be selected for the new mine.

Table 19-2 Equipment Air Consumption

EQUIPMENT	MAX No. EMPLOYED	OPERATING CONSUMPTION	OPERATING HOURS/SHIFT	PER CENT UTILIZATION	AIR CONSUMPTION (CFM)		
					SINK No.1 SHAFT	PREPROD. DEVELOP.	PROD. 3,000 TPD
Surface Shops	1	60	7	50%	26	26	26
Collar Doors	1	40	1	20%	1	1	
Dump Doors	1	75	1	20%	2	2	
Collar Tugger hoist	1	150	1	10%	2	2	
Station Tugger hoists	3	150	1	10%			6
Chutes	3	50	2	20%	8		8
Cylinders (underground)	8	50	2	30%			30
Brutus Mucker	2	1500	8	95%	2850	1425	
Cryderman Mucker	0	1200	0	100%			
Blow Pipes 2"	1	1000	2	15%		38	38
Pluggers	0	180	0	0%			
Stoppers	6	180	5	75%		253	506
Jack-legs	6	180	5	75%		253	506
Air Diamond Drills	0	300	0	0%			
Hyd Diamond Drills	6	0	7	80%			
Shotcrete Machine	2	750	5	100%		469	938
Air movers	6	40	8	100%		120	240
Raise Borer RB 40*	2	600	7	20%			210
Raise Borer 61R, 71R*	1	800	7	20%		140	140
Raise Borer 82R*	0	900	7	20%			
Air Alimak Motor	0	95	2	100%			
Alimak Vent - Air/elec	2	400	7	100%		700	350
Alimak Vent - Diesel	0	750	0	0%			
LM 250 Loader	0	600	0	0%			
Hagglund Car	0	480	0	0%			
Mobile Scaler (Hyd.)	0	0	4	80%			
Mobile Bolter	2	0	5	80%			
Vent Refuge Station	1	20	8	100%		20	20
Underground Garage	1	60	7	50%		13	26
Service Bay	2	20	8	20%		8	8
Pneum. Rockbreaker	0	600	0	100%			
Hyd. Rockbreaker	2	0	4	100%			
ITH Stope drills 10"	4	900	0	0%			
ITH Stope drills 8"	4	550	7	75%			1444
ITH Stope drills 6"	0	450	0	0%			
ITH Stope drills 4.5"	0	350	0	0%			
Top Hammer drills 2.5"	0	250	0	0%			
Hyd. Top hammer drills	4	0	6	0%			
Air Welders	0	50	0	0%			
Air Lifts	0	50	0	0%			
Air Op. Fans	0	75	0	0%			
Air Lights	0	50	0	0%			
SUBTOTAL					2889	3470	4495
Contingency (10%)					289	347	449
SUBTOTAL					3177	3817	4944
Line Losses (Leaks)					159	572	989
SUBTOTAL					3336	4389	5933
DESIGN CAPACITY					3300	4500	6000
STANDBY CAPACITY					1100	1500	2000
PLANT CAPACITY					4000	6000	8000
* Compressed air required for drilling pilot holes.							

19.10 Altitude and Depth

The atmospheric pressure is less at high altitude than it is at sea level. The atmospheric pressure in a deep mine is greater. The same is true of a column of compressed air such as the airline in a mineshaft. The compressed air in a shaft column will gain more pressure with depth than the atmosphere and so the gage pressure will increase at the bottom of a mineshaft. (If the airflow is moving, this gain will be mitigated by friction.) The difference in atmospheric pressure and gage pressure due to change in altitude may be considered adiabatic and each calculated with the following formula.

$$P_2 = P_1 [1 - g(z_1 - z_2) / T_1 C_p]^{1/k}$$

In which, $T_1 = 20^\circ\text{C} = 293^\circ\text{K}$ (atmosphere)

P_2 = Final pressure, kPa

$T_1 = 40^\circ\text{C} = 313^\circ\text{K}$ (compressed air)

P_1 = Initial pressure, kPa

$C_p = 1014 \text{ J/kgK}$ (atmosphere)

$g = 9.81 \text{ m}^2/\text{s}$

$C_p = 1079 \text{ J/kgK}$ (compressed air)

z_1 = initial altitude, m

$1/k = 3.500$ (atmosphere)

z_2 = final altitude, m

$1/k = 3.759$ (compressed air)

Example

Determine the atmospheric pressure and the static airline pressure for the following situation.

- Facts:
1. The depth is 2,000m
 2. The mine has a compressor at sea level
 3. The atmospheric pressure is 101.3 kPa (14.7 psi)
 4. The air is compressed to a gage pressure of 689 kPa (100 psi)

Solution:

1. Atmospheric pressure at depth

$$P_2 = P_1 [1 - g(z_1 - z_2) / (T_1 C_p)]^{1/k} = 101.3 [1 - 9.81(0 - 2,000) / (293 \times 1014)]^{3.500} = 127 \text{ kPa}$$

2. Compressed air pressure at depth

$$P_2 = P_1 [1 - g(z_1 - z_2) / T_1 C_p]^{1/k} = (689 + 101.3) [1 - 9.81(0 - 2,000) / (313 \times 1079)]^{3.759} = 977 \text{ kPa}$$

3. Gage pressure at depth = 977 - 127 = 850 kPa (123.4 psi)

In Table 19-3, this sample problem is extended for different altitudes and depths of mining.

Table 19-3 Standard Atmosphere at Altitudes/Depths and Air Compressed to 100psig (689 kPa) at Sea Level

Altitude	Standard Atmospheric Pressure	Compressed Air Pressure (absolute)	Compressed Air Pressure (gage)	Compressed Air Pressure (gauge)	Compressed Air Pressure (absolute)	Standard Atmospheric Pressure	Altitude
(feet)	(psia)	(psia)	(psig)	(kPa)	(kPa)	(kPa)	(m)
15,000	8.29	67.1	58.8	406	463	57	4,572
14,765	8.37	67.7	59.4	409	467	58	4,500
12,500	9.18	73.8	64.6	446	509	63	3,810
11,484	9.56	76.7	67.1	463	528	66	3,500
10,000	10.14	81.0	70.8	488	558	70	3,048
8,203	10.87	86.4	75.5	521	596	75	2,500
7,500	11.17	88.6	77.4	534	611	77	2,286
6,562	11.57	91.6	80.0	552	631	80	2,000
5,000	12.27	96.7	84.5	582	667	85	1,524
4,922	12.31	97.0	84.7	584	669	85	1,500
3,281	13.07	102.7	89.6	618	708	90	1,000
2,500	13.45	105.4	92.0	634	727	93	762
1,641	13.87	108.6	94.7	653	749	96	500
Sea Level	14.70	114.7	100.0	689	791	101	Sea Level
-1,641	15.57	121.1	105.5	728	835	107	-500
-2,500	16.04	124.5	108.5	748	859	111	-762
-3,281	16.47	127.7	111.3	767	881	114	-1,000
-4,922	17.41	134.6	117.2	808	928	120	-1,500
-5,000	17.46	135.0	117.5	810	931	120	-1,524
-6,562	18.39	141.8	123.4	851	978	127	-2,000
-7,500	18.96	146.1	127.1	876	1007	131	-2,286
-8,203	19.40	149.3	129.9	896	1029	134	-2,500
-10,000	20.56	157.8	137.2	946	1088	142	-3,048
-11,484	21.56	165.1	143.5	989	1138	149	-3,500
-12,500	22.25	170.2	147.9	1020	1173	153	-3,810
-14,765	23.87	182.0	158.2	1090	1255	165	-4,500
-15,000	24.04	183.3	159.2	1098	1264	166	-4,572

20.0 Mine Dewatering

20.1 Introduction

Any open pit and almost any underground mine is a vast sump collecting water. The water naturally tends to accumulate at the bottom of the workings and the flow scours fine material and holds it in suspension. Dewatering a mine encompasses not only the water but also the fines contained in the water. The task is aggravated in some mines because fines can significantly alter the pH of the mine water. Many base metal mines have to contend with acid water (pH as low as 2) while other mines have problems with high alkalinity.

The mine dewatering process includes the following activities.

- Prevention
- Collection and containment
- Removal
- Disposal

Prevention

Rainfall and snow cannot be prevented from falling directly into an open pit; however, ditches diverting the flow away from the workings can prevent the overland flow of water into the excavation. Water flow from the overburden soil at a pit rim can be collected and pumped to the diversion ditches. Water that seeps through the rock walls (ground water) of the pit may be redirected by collection from drill holes or lowering the ground water table in the bedrock by drilling and pumping from deep wells.

Entries to underground mines are prone to collect water. Surface flow is prevented by locating entries on high ground, sloping the terrain away from entries, or placing a reverse slope at the top of a ramp entry.

Flow of water through the overburden is prevented by sealing the entry down to (and into) the bedrock or collecting and redirecting the water.

Ground water flowing into an underground entry (shaft, raise, ramp or adit) is most often controlled by injection grouting. In special cases, a vertical entry is sealed with an impervious (hydrostatic) lining designed to withstand the pressure of the ground water.

Many open pit mines and some underground mines reduce the flow of ground water with deep well ITH pumps. A few underground mines reduce the flow with curtain grouting.

Collection and Containment

Mine water that reaches the workings is typically collected and confined to a central location(s) using ditches, boreholes, and piping arranged to prevent accumulation and limit fines contamination. The containment is required to provide surge capacity in the event of a power outage or pump failure and offers the opportunity for settling fines (slimes) before pumping the decanted water.

Removal

If the terrain permits, collected water may be removed through a drainage tunnel, but usually pumping is required. For most applications, centrifugal motor pumps are used as the prime movers. Water is normally directed to a settling sump(s) and the overflow of clear water to a “clean water” sump for main line pumping. Handling the sediment (slimes) that deposit in the sumps is a significant problem, especially for underground mines.

Centrifugal pumps are available for high volumes that can pump “dirty” mine water (not allowed to settle). If the quantity of dirty water is relatively small, piston diaphragm pumps can deliver in a single stage from great depths. Diaphragm pumps may be used for new mines but are typically installed in existing operations to pump from a new horizon up to an existing clear water system.

Most mine pumps are electrically powered. Pneumatic powered pumps are sometimes used as sump pumps, but the airlift is seldom employed any more (except for testing vertical holes drilled from surface for dewatering). A recent innovation developed in Great Britain is the hydraulic-powered diaphragm pump that employs the head of service water supply lines as the driving force.

Disposal

Treatment and disposal (or recycling) of mine water on surface is discussed in detail in Section 5 – Environmental Engineering. Treatment underground is confined to dosing with a flocculent. Adding lime underground is believed to promote calcium compound deposits (principally CaCO_3) inside pipelines and should be avoided.

20.2 Rules of Thumb

Water Balance

- The average consumption of service water for an underground mine is estimated at 30 US gallons per ton of ore mined per day. The peak consumption (for which the water supply piping is designed) can be estimated at 100 USGPM per ton of ore mined per day. *Source: Andy Pitz*
- Ore hoisted from an underground hard rock mine has moisture content of approximately 3%. *Source: Larry Cooper*
- A water fountain left running underground wastes 1,100 USGPD. *Source: Jack de la Vergne*
- A diesel engine produces 1.2 litres (or gallons) of moisture for each litre (or gallon) of fuel consumed. *Source: John Marks*
- In the hard rock mines of the Canadian Shield, ground water is seldom encountered by mine development below 450m (1,500 feet). This may be because the increased ground stress at depth tends to close the joints and fractures that normally conduct water. *Source: Jim Redpath*

Layout

- The main pump station underground must have sufficient excavations beneath it to protect from the longest power failure. The suggested minimum capacity of the excavations is 24 hours and a typical design value is 36 hours. *Source: Jack de la Vergne*
- The main pumps should be placed close to the sump so that the separation will allow for a minimum straight run of pipe equal to five times (preferably ten times) the diameter of the pipe. *Various Sources*
- Allow one square foot of surface area/USGPM in the design of a settling sump. (Refer to Section 20.13.) *Source: Raul Deyden*
- Turbulence will be sufficient to ensure good mixing of a flocculating agent if the water velocity is at least 1m/s and maintained for 30 seconds in a feed pipe or channel. *Source: NMERI of South Africa*

Design

- Piping for long runs should be selected on the basis that the water velocity in the pipe will be near 10 feet/sec (3m/s). The speed may be increased up to 50% in short runs. *Various Sources*
 - In underground mines, static head is the significant factor for pump design if the pipes are sized properly. To obtain the total head, 5 -10% may be added to the static head to account for all the friction losses without sacrificing accuracy. *Source: Andy Pitz*
 - Pump stations for a deep mine served by centrifugal pumps are most economically placed at approximately 2,000-foot (600m) intervals. *Source: Andy Pitz*
 - A tonne of water a second pumped up 100m requires 1MW of power. *Source: Frank Russell*
 - The outlet velocity of a centrifugal pump should be between 10 and 15 feet per second to be economical. *Source: Queen's University*
 - A sump should have a live volume equal to at least 2½ times the pump operating rate to limit pump starts to six per hour (typical NEMA B motor). For example, the live volume of the sump for a 500 USGPM pump should be at least 1,250 gallons. *Source: Lauren Roberts*
 - Centrifugal pumps should not operate at a speed exceeding 1,800 RPM (except for temporary or small pumps that may operate at 3,600 RPM). This is because impeller wear is proportional to the 2.5 power of the speed. In other words, half the speed means nearly six times the impeller life. *Source: Canadian Mine Journal*
 - The maximum lift of a centrifugal pump is a function of the motor torque, which in turn is a function of the supply voltage. Since it is a squared function, a 10% drop in line voltage can result in a 20% loss in head. *Source: Jack de la Vergne*
 - The velocity of dirty water being pumped should be greater than 2 fps in vertical piping and 5 fps in horizontal piping. These speeds are recommended to inhibit solids from settling. *Source: GEHO*
 - Slime particles less than 5µ in diameter cannot be precipitated without use of a flocculating agent. *Source: B. N. Soutar*
-

20.3 Tricks of the Trade

- The best layout for a main pump station has the pumps fed from the sump with a positive suction head (i.e. the sump outlet is higher than the pump). If the sump is below the pumps, water is not “pulled” up the suction pipe, it is “pushed” by atmospheric pressure. At a mine where the water flow is relatively small, the lift can be as much as 6m (20 feet). At high rates of flow, the lift is less and for mines at high altitude lift can be reduced to near zero. If the suction lift is too high the result is “cavitation,” which makes the pump sound like it is pumping gravel. Cavitation reduces pump capacity and is blamed for pitting the impeller, erratic power consumption, loss of head, bearing failure, and other mechanical damage from vibration. *Source:* Travis Glover
- Collecting water from rings (“launders”) in a shaft can provide process water for the operations without water pressure reduction and lowers the total volume to be pumped out of the mine. *Source:* Peele
- Commercial water blasters (or shop made blow pipes that use compressed air to provide a high velocity water stream) use as little as 10% of the water required for washing equipment with an open water hose. *Source:* Jack de la Vergne
- Employing disc (instead of button) cutters on raisebore heads will significantly reduce the amount of slimes generated in an underground mine. *Source:* Pete Guthrie
- Small bulldozers and drags are sometimes used to grade trackless headings; however, the only suitable equipment is a motor grader. On surface roads, these machines may make a first pass each way deflecting material from the crown to the sides and a second pass to restore the crown and provide final grade. The first pass should be omitted underground. The resulting hump at the crown can easily be negotiated by trackless equipment and fines are not directed towards the ditch. *Various Sources*
- Ground water dribbling from the back of a trackless heading can be diverted to fall in the ditch with the placement of a corrugated sheet metal deflector. This procedure prevents potholes and reduces slimes generation. *Source:* Marshall Hamilton
- The addition of a flocculating agent to hydraulic fill will reduce the amount of slimes in the decant water. *Source:* Jim Devlin
- Ore and waste passes should not allow entry of collected mine water for several reasons. It is especially important to ensure that decant water from cemented fill and spill or flush water from fill lines do not enter an ore or waste pass because this water contains particles of fresh cement promoting hang-ups in passes and rat holing in bins. *Source:* Fred Brackebusch
- A neat way to handle decanted slimes is to pump them into the outlet pipe of a clear water pump station. An electrically driven standard duplex grout pump facilitates the necessary interlock so it will stop when the main pumps stop. *Source:* Bill Shaver
- A drainage borehole underground will become blocked with a screened entry. A better device is a fabricated guard made with an angled lip to fit in the hole, three vertical rods, and a flat plate on top with a handle. *Source:* John Baz-Dresch
- Mines usually run centrifugal pumps intermittently to accommodate fluctuations in supply. Another practical method is to choke the output. Choking decreases the power draw and slight choking may increase pump efficiency. Choking is also useful to correct an over-heating pump motor. *Source:* Lindsay Baxter
- If the design head of a centrifugal pump is greater than the actual, the quantity (flow rate) will be increased but the motor may be overloaded. This may be corrected by (1) slightly throttling (choking) the discharge, or (2) reducing the vane (impeller) diameter without altering the shrouding (casing). This can be done within 10% of the vane diameter. The latter modification is possible since in a centrifugal pump the head is proportional to the square of the vane diameter. *Source:* F. Gimkey
- Nuisance water at a face or bench can be pumped into a haul truck or shaft bucket to fill the voids in the muck that may amount to 25% of the volume. *Source:* Jack de la Vergne
- Mine slimes should be assayed and analyzed to help ascertain the sources and determine whether they should be directed to the mill. *Source:* Rory Mutch
- Diamond drill and reverse circulation holes drilled from surface for grade determination may also provide the means to predict the rate of ground water flow into a proposed mining operation if they are properly utilized for this purpose. Water-bearing faults, joints, and aquifers may be identified and assessed by the following means: regular drillwater sample analysis, cuttings analysis, rate of penetration, loss of drill water into formation, airlift measurements, falling head measurements, and packer tests. *Various Sources*

- Water flows up to 25 USGPM (1.6 l/s) are easy to determine accurately by measuring the time it takes to fill a five-gallon pail. *Source:* Jim Redpath
- Water flow from a horizontal pipe is easily determined by measuring the distance to a drop of 4 inches (100mm) in the flow (refer to Section 20.6). *Source:* Pleuger Unterwasserpumpen GMBH
- Water flowing up from a vertical drill hole is easily determined by measuring the height of flow (refer to Section 20.6). *Source:* Khoa Mai
- Water flow in a ditch is most practically measured by installing a portable weir box and measuring the true head of flow over the crest (refer to Section 20.6). *Source:* William Staley

20.4 Source of Slimes

Water collected in a mine contains particles of solid material referred to as fines or slimes. Limiting the generation of slime material is one of the disciplines directly related to mine dewatering. To enact control measures, sources of slime must be identified (listed below).

- Drilling
- Raiseboring
- Hydraulic fill decant
- Fault gouge
- Overloading of explosives
- Crushing and breaking
- Attrition in the ore/waste handling system
- Attrition in the road dressing/rock fill handling system
- Comminution on haulage ways
- Flushing fill lines
- Breaking plugged fill lines
- Oxidation – Pyrite in the ore produces colloidal ferric hydroxide, Fe(OH)₃

20.5 The Water Balance

The most important activity in analyzing a mine dewatering system is to compile a water balance that identifies sources and defines the pumping rate. In temperate climates, less water is pumped in winter months than spring and summer. In this event, two separate balances must be compiled. The sources are typically surface water, ground water, service water (drilling, dust suppression and washing), decant from hydraulic fill, flush water from fill and slurry lines, and condensation from ventilation air or chillers. Some of this water is removed to surface in the ore and waste rock stream or evaporates into a ventilation circuit. The remainder must be pumped. Table 20-1 is an example of an underground mine water balance.

Table 20-1 Underground Mine Water Balance

Origin	Description	Inflow USGPD	Outflow USGPD
Ground water	Shafts and raises to surface	140,000	
	Down the ramp	25,000	
	Diamond drill holes	75,000	
	Other	45,000	
	Collected for service water		85,000
Service water	Drilling	90,000	
	Dust control	25,000	
	Washing	10,000	
	Chillers	0	
	Leaks in pipelines	15,000	
Backfill	Decant water	0	
	Flush water	6,000	
Diesel exhaust	Trackless fleet	4,000	
Ore and waste rock	(3% moisture content)		25,000
Slimes	Removal from mine		5,000
Ventilation	Evaporation/Condensation		10,000
Pumping	Main mine pumps		310,000
TOTALS		435,000	435,000

20.6 Estimating and Measuring Water Flows

Predicting anticipated flow in the overburden soils is a highly developed science (hydrology), which has its roots in estimating the capacity of drilled wells. Calculations for a mine application are typically complex and best performed by a specialist.

Predicting ground water flows in porous rock may be accomplished by determining the fall of head in a drilled well or by packer tests in a borehole to produce reliable results.

Predicting ground water flow into a hard rock mine is difficult because its source is typically from irregular fissures and joints in the rock; therefore, it is very difficult to predict with any accuracy. Normally, packer tests in drilled holes provide an order of magnitude for the anticipated flow, but in numerous instances the resulting estimates were completely wrong. As a rule, an accurate estimate of the ground water flow into a proposed hard rock mine can only be obtained from driving an exploration or development entry (shaft, adit, or ramp).

The measurement of relatively small quantities of water is most easily accomplished by the time required to fill a pail or bucket of known volume (for example, a 5-gallon pail).

The flow measurement from a horizontal open-ended pipe may be determined by measuring the distance to a predetermined drop of the water stream. If the distance to where the drop is 4 inches (100mm) is measured, the flow can be obtained from Table 20-2 (providing flow rates in USGPM for schedule 40 pipe).

$$1 \text{ m}^3/\text{min} = 16.67 \text{ l/s} = 35.3 \text{ cfm} = 264 \text{ USGPM}$$

$$1 \text{ l/s} = 15.85 \text{ USGPM}$$

Table 20-2 Flow Rates (USGPM)

Horizontal distance Diameter of Pipe	6"	8"	10"	12"	14"	16"
	FLOW RATE (USGPM)					
1½"	20	27	33	40	46	53
2"	33	44	55	66	77	88
3"	72	96	120	145	169	193
4"	124	166	207	249	290	332
6"	283	377	471	565	659	753
8"	500	667	834	1,001	1,167	1,334
10"	798	1,064	1,330	1,596	1,861	2,127

The quantity (Q) of water flowing upwards from a hole drilled vertically can be estimated by measuring the height of flow (H) over the collar of the hole.

$$Q = 5.1 D^2 H^{1/2}$$

In which, D is the hole diameter (inches)

H is the height of flow (inches)

Q is the flow in USGPM

The flow rate from a sinker drill (plugger) hole can be quickly determined by measuring the height of flow and comparing it with the data in Table 20-3.

Table 20-3 Flow Rate from a 1.38-inch Diameter Hole

H, inches	0.25	0.5	0.75	1	1.5	2	3	6	12
Q, USGPM	4.9	6.9	8.4	9.7	12	14	17	24	34

The quantity of water flowing in a typical underground hard rock mine ditch can be measured with a portable weir box made from wood or sheet metal. A three-foot box is long enough for the flows found in typical ditches. If the weir extends across the full width of the box and the box is placed level in the ditch, the quantity (in USGPM) may be determined by using the following formula.

$$Q = 3.0 bH^{1.5}$$

b is the length in inches of the weir (box width), H is the head measured in inches well back from the crest of the weir, and Q is USGPM. Table 20-4 provides flow rates for an 8-inch wide weir box (a convenient dimension for a portable unit).

Table 20-4 Flow Rates for an 8-inch Wide Weir Box

H, inches	0.5	1	2	3	4	5
Q, USGPM	8.5	24	68	125	192	268

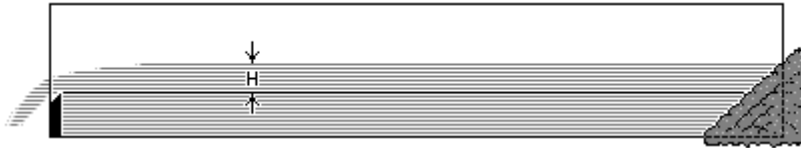
**Figure 20-1 Portable Weir Box in Ditch**

The velocity of water flowing in a large rectangular ditch of uniform cross-section may be determined by timing an object floating downstream in the middle of the ditch over a fixed distance. The average velocity will be 74% of this value for a rock ditch and 88% for a smooth concrete-lined ditch. The area is the width of the ditch times the wet depth. The quantity is the product of the average velocity and the area measured.

20.7 Clear Water Pumping

Clear water is mine water for pumping containing less than 250 ppm of suspended solids that do not exceed 35μ in size. A stricter definition is water containing less than 100 ppm of particles not exceeding 25μ . Clear water pumped from mines often exceeds these criteria causing short life of pump components leading to high maintenance and repair costs.

Sumps

Particles as small as 5μ may be decanted but the retention time and the resulting sump size is not practical in a mine.

Typical practice underground is to excavate two horizontal settling sumps, one of which continues to operate while the other is being cleaned of slimes. Smaller operations often employ a single cone or fan shaped vertical settling sump from which the slimes can be drawn off while maintaining the mine water flow. If not wisely designed and carefully maintained, neither a horizontal nor a vertical settler will work with any lasting efficiency.

Slimes

Slimes in a horizontal settling sump are about 15% solids by weight. When the sump is drained, slimes will increase to approximately 30%. This material is difficult and messy to handle, even when left for a week or more to consolidate further. At least one mine doubled the solids content when drained by using a flocculating agent.

Centrifugal Pumps

Mines invariably select centrifugal pumps as the prime mover for dewatering. Centrifugal pumps are reliable, relatively compact, and the multi-stages required for high heads can direct drive with a single motor. Disadvantages include that they are efficient in a relatively narrow operating range making variable speed drives not practical. Additionally, if a centrifugal pump runs dry, or even when the outlet pipe is broken near the pump, they can draw enough amperage to burn out the motor.

Centrifugal pumps have the following (approximate) characteristics.

- Capacity varies directly with the speed of the impeller (RPM)
- Capacity varies directly with the diameter of the impeller, D
- The head varies with $(\text{RPM})^2$
- The head varies with D^2
- The power drawn varies with $(\text{RPM})^3$
- The power drawn varies with D^3

20.8 Dirty Water Pumping

Providing sufficient settling sump capacity in underground mines that experience huge inflows of ground water is not practical. For this application, specially designed centrifugal pumps are employed – dirty water pumps. Characteristics of dirty water pumps are significantly different from the low-head centrifugal slurry pumps employed in mine concentrators where the particles pumped are finely ground. Linings made of natural rubber, neoprene, polyurethane, etc. are often used for these low-head pumps. Dirty water centrifugal pumps for mine service require wear surfaces of hard, tough, abrasion resistant metal. In general, the hardness required (measured on a Brinell scale) is related to the hardness of the particles of sediment (measured on Moh's scale). Typical rocks in a metal mine have the hardness of feldspar. These particles are approximately as hard as

work-hardened manganese steel; however, high silica content often exists in hard rock. Silica has the hardness of quartz on the Moh's Scale. Pyrite is almost as hard as silica. These can only be matched on the Brinell Scale with special alloys, such as one containing 28% chromium.

Hardness is not the only wear factor, dense particles cause more wear since the kinetic energy is higher. Angular particles cause twice as much wear as rounded ones. Up to 10%, the wear rate is almost directly proportional to the concentration of fines. This is one reason why centrifugal dirty water pumps have better application when there is a high volume of water to be pumped from the mine.

Since wear increases exponentially with the velocity (approximately $V^{2.6}$) of the particles in the water, it is prudent to sacrifice some efficiency and use a slightly larger sized pump than would be employed for the same service with clear water.

The minimum clearance between rotating parts in a clear water centrifugal pump is approximately 75 μ , which is why clear water is defined as containing nothing larger than 37 μ (to avoid bridging). This clearance may be altered for a dirty water centrifugal pump in mine service, which can slightly lower its efficiency.

Unlike clear water, dirty water centrifugal pumps are often V belt driven which may add 5% to the power losses, but provides a practical means to obtain an efficient pump design using a standard impeller diameter and a standard motor speed.

In the case of high heads and relatively small volumes, the modern piston diaphragm pump provides reliable service at a high capital cost. These pumps run continuously but capacity can only be adjusted in a relatively narrow range, unless they are fitted with variable speed motors. The feed water is normally collected in a small sump to facilitate agitation and provide a constant solids content. The piston diaphragm pump has a head capacity high enough to pump to surface in one lift from any depth of mine operations. The pump system cost increases at great depths because pipe beyond schedule 80 normally costs twice as much per pound (or kg) – besides being thicker walled. Maintenance cost for these pumps is low.

20.9 Drainage Tunnels

In mountainous or hilly terrain, drainage tunnels may be an economical alternative to pumping. Drainage tunnels are driven at an elevation beneath the mine workings. The gradient is normally higher than normal for a rail heading – 1% is typical and 1.5% considered a maximum. The heading incorporates a large ditch on one side that is advanced with the face. The ditch dimension is usually square, 3 feet by 3 feet or 1m by 1m. Driving a heading with this huge ditch is difficult to mechanize, often resulting in slow progress. (In unusual circumstances, the heading may be driven with a conventional ditch and designed to flow nearly full when completed.) Checking by Froude's Number confirms that these ditches will not experience hydraulic jump. The ditch capacity, Q, may then be simply determined by modifying Manning's formula.

$$Q = 25,000A^{5/3}S^{1/2}/P^{2/3} \text{ (metric units)}$$

A is area, S is slope (gradient of the tunnel), P is the wetted perimeter, and the formula assumes a roughness coefficient, $n = 0.04$, in this case.

For a fixed cross section and depth of flow, the equation is simplified to $Q = k S^{1/2}$ (k is a constant). The rate of flow is directly proportional to the square root of the gradient.

The following tabulation (Table 20-5) may be used to determine the capacity of a standard (1m)² drainage tunnel ditch flowing 95% full at differing gradients.

Table 20-5 Standard Drainage Tunnel Capacity

Gradient of (1.0m) ² Ditch	Capacity (l/s)	Capacity (USGPM)
0.50%	800	12,600
0.75%	975	15,400
1.00%	1,125	17,800
1.25%	1,250	20,000
1.50%	1,375	21,800

The capacity of a drainage ditch cut in rock may be more than doubled if it is smooth lined with concrete (roughness coefficient, $n = 0.014$, in this case). In the case of a square concrete-lined ditch, the following formula may be employed to provide satisfactory answers.

$$Q = 70,000A^{5/3}S^{1/2}/P^{2/3} \text{ (metric units)}$$

20.10 Centrifugal Pump Selection

A centrifugal pump is primarily described by its outlet size. The size of a pump is determined by its outlet velocity, which can be determined by the following equation.

$$Q = V \cdot A$$

In which, Q = Rate of flow in CFS (m^3/s)

V = Average velocity in FPS (m/s)

A = True area of pump outlet ft^2 (m^2)

Table 20-6 True Area of Outlet

Standard Size (in.)	True Area of Outlet (ft^2)	True Area of Outlet (m^2)
1	0.0060	0.00056
1 1/4	0.1040	0.00966
1 1/2	0.0141	0.00131
2	0.0232	0.00216
2 1/2	0.0333	0.00309
3	0.0513	0.00477
3 1/2	0.0686	0.00637
4	0.0884	0.00821
5	0.1390	0.01291
6	0.2006	0.01863
8	0.3474	0.03227
10	0.5475	0.05086
12	0.7773	0.07221
14	0.9394	0.08726
16	1.2272	0.11400

- If the outlet velocity is greater than 15 fps (4.6m/s), the pump is too small.
- If the outlet velocity is less than 10 fps (3.0m/s), the pump is over-designed and oversized.
- Pump efficiency depends on the specific speed (N_s) of its impeller.

$$N_s = N Q^{1/2} H^{3/4}$$

In which, Q = Rate of flow

H = Total friction head

N = RPM of the impeller

The formula is valid for metric or imperial units. The flow rate, Q is expressed in USGPM in many pump catalogues; however, using CFS (cubic feet per second) instead produces values that are simpler to use and cause no confusion between US and imperial gallons.

$$N_s \text{ (USGPM)} = 17.66 N_s \text{ (CFS)}$$

Most centrifugal pumps are direct-driven by an induction motor, so N must be a reasonable standard motor speed such as 3,450 RPM (usually small or temporary pumps only), 1,750-RPM, or 1,160-RPM. For typical underground mine service, calculations reveal that higher speeds are more efficient (and higher speed motors are less expensive).

- For most mine service, a pump will be most efficient if the N_s (CFS units for Q) is between 100 and 200.
- If the calculated N_s (CFS) is less than 50 – select as many smaller centrifugal pumps as required so that the specific speed of each exceeds 50 (multi-stage pumps in series).
- If the specific speed (CFS) is between 50 and 200, select a single centrifugal pump.
- If the specific speed (CFS) is over 200 and less than 400, two centrifugal pumps in parallel may be employed.

The following figure plots the range of efficiencies for typical mine application. For a given specific speed, the higher values for efficiency refer to new high volume pumps of efficient design. Centrifugal pumps of relatively small capacity and subjected to wear will have lower efficiency.

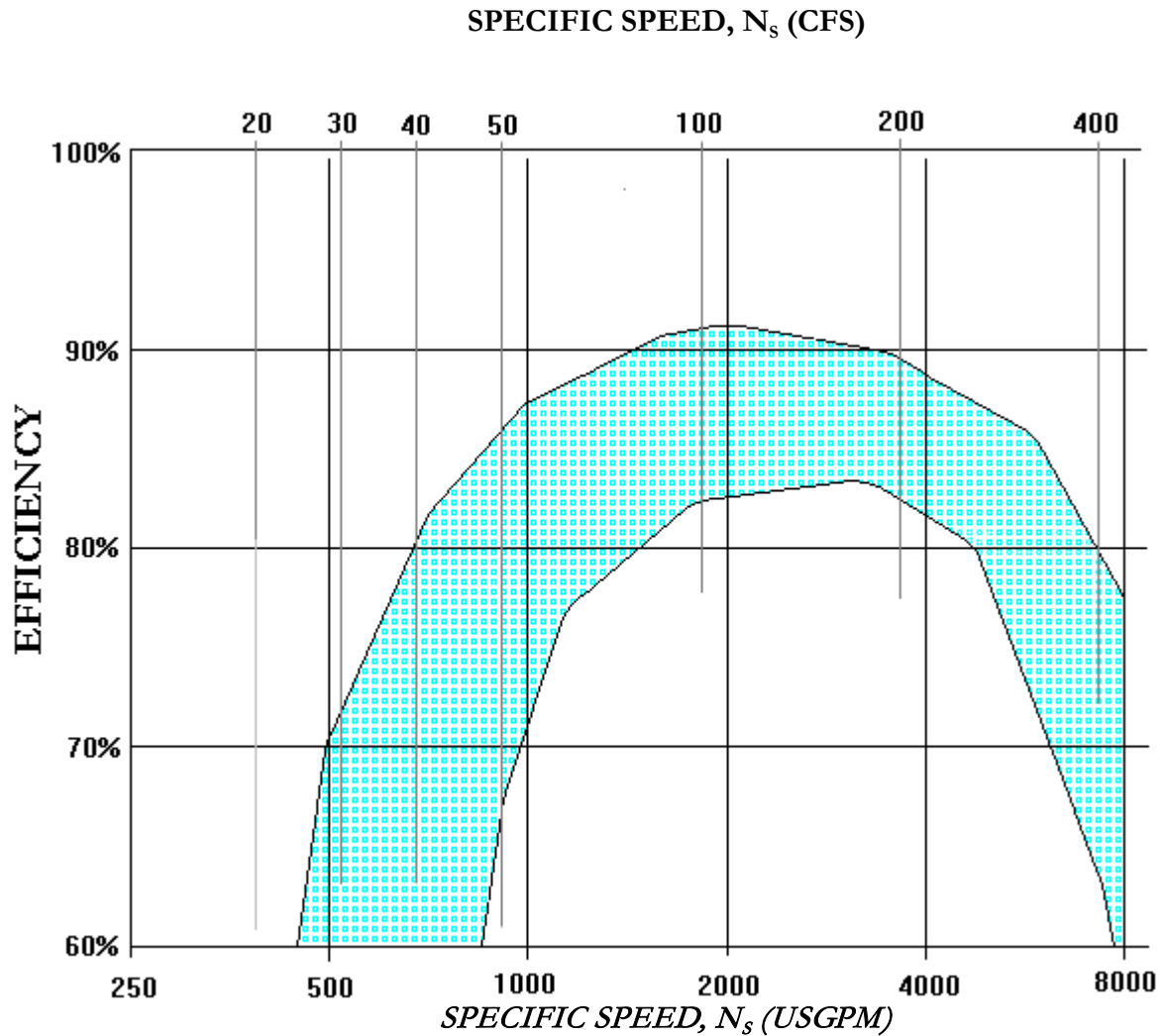

Figure 20-2 Range of Efficiencies

The following formulae may be used to calculate the required motor horsepower with the efficiency determined from the specific speed chart above or from charts in pump manufacturers' literature.

$$HP = \frac{QWH}{550E}$$

- In which,
- Q = Flow Rate (cfs)
 - W = 62.4 Lbs. per cubic foot (for clear water)
 - H = Total Head (feet)
 - E = Pump Efficiency

$$HP = \frac{QH}{3960E}$$

In which, Q = Flow Rate (USGPM)
 H = Total Head (feet)
 E = Pump Efficiency

With the pump horsepower determined, select the next highest standard sized motor (refer to Table 20-7).

Table 20-7 Standard Electric Motors

0.25 HP	20 HP	225 HP	1,000 HP
0.33 HP	25 HP	250 HP	1,250 HP
0.50 HP	30 HP	300 HP	1,500 HP
1.00 HP	40 HP	350 HP	1,750 HP
1.50 HP	50 HP	400 HP	2,000 HP
2.00 HP	60 HP	450 HP	2,250 HP
3.00 HP	75 HP	500 HP	3,000 HP
5.00 HP	100 HP	600 HP	3,500 HP
7.50 HP	125 HP	700 HP	4,000 HP
10.00 HP	150 HP	800 HP	4,500 HP
15.00 HP	200 HP	900 HP	5,000 HP

The standard motor sizes produced overseas are the same sizes but expressed in kilowatts (soft conversion). A 15 kW motor is the same as a 20 HP motor. Some additional standard sizes are manufactured that do not correspond to those tabulated above (80 kW, 120 kW).

20.11 Friction Head Loss in Steel Pipe

The standard (Hazen-Williams) formula is expressed as follows.

$$h_f = 0.002083 \cdot L \cdot \left(\frac{100}{C}\right)^{1.85} \times \frac{Q^{1.85}}{d^{4.8655}}$$

In which, hf = Head loss due to friction in feet of liquid
 d = Inside diameter of circular pipe in inches
 C = Friction factor (Hazen-Williams)
 L = Length of pipe including equivalent length for loss through fittings in feet
 Q = Flow of liquid in USGPM

The "C" Factor for steel pipe used in mine dewatering design is typically 120, therefore, the equation can be simplified to the following.

$$h_f = \frac{LQ^{1.85}}{673d^{4.87}}$$

This equation is valid for either clean or dirty water pumping; however, it is not valid for slurry pumping when the solids content exceeds 40% by weight. It is never valid for pumping viscous fluids, such as diesel and fuel oil.

Table 20-8 Friction Head Loss (Feet) per 100 Feet of Schedule 40 Steel Pipe (Mine Service)

Pipe diameter	1	1½	2	3	4	6	8	10	12	14	16
Flow USGPM	Head Loss (Feet of Water)										
10	8.33	1.03	0.31	0.04							
20	30.00	3.73	1.10	0.16	0.04						
30	63.60	7.90	2.34	0.34	0.09						
40	108.30	13.40	3.98	0.58	0.15						
50		20.30	6.02	0.88	0.23						
60		28.50	8.43	1.23	0.33	0.04					
70		37.90	11.20	1.64	0.44	0.06					
80		48.50	14.40	2.10	0.56	0.08					
90		60.30	17.80	2.61	0.69	0.09					
100		73.20	21.70	3.17	0.84	0.11					
125		110.70	32.80	4.79	1.28	0.17	0.05				
150			45.90	6.71	1.79	0.24	0.06				
175			61.10	8.90	2.38	0.32	0.08				
200			78.20	11.40	3.04	0.41	0.11				
250			118.20	17.30	4.60	0.62	0.16	0.05			
300				24.20	6.44	0.88	0.23	0.08			
400				41.20	11.00	1.49	0.39	0.13	0.06		
500				62.20	16.60	2.25	0.59	0.20	0.08	0.05	
750					35.10	4.77	1.25	0.41	0.18	0.11	0.06
1,000					59.70	8.12	2.13	0.70	0.30	0.19	0.10
1,500					126.50	17.20	4.52	1.49	0.64	0.40	0.21
2,000						29.30	7.69	2.54	1.08	0.68	0.36
3,000						62.00	16.30	5.38	2.29	1.44	0.75
4,000						105.50	27.70	9.15	3.90	2.46	1.28
5,000							41.90	13.80	5.89	3.71	1.94
7,500							88.70	29.30	12.50	7.86	4.10
10,000								49.90	21.20	13.40	6.99
15,000								105.60	45.00	28.30	14.80
20,000									76.60	48.30	25.20
30,000										102.20	53.30
Pipe diameter	1	1½	2	3	4	6	8	10	12	14	16

20.12 Minimum Wall Thickness of Piping

In calculating the wall thickness of piping for the transmission of clear water, the following formula can be used.

$$t = 1.15 \cdot \left[\frac{PD}{2s + Py} \right] + c$$

- In which,
- t = Wall thickness (in.)
 - D = Outside diameter of pipe (in.)
 - P = Maximum internal pressure (psi)
 - y = Temperature coefficient, typically equal to 0.4
 - s = Allowable stress in pipe (psi) - equal to 50% of yield strength (typically, s=17,500 psi)

- c = allowance for corrosion, equal to 0.062 in. (typical)
- + allowance for depth of thread (screw fitting), or
- + depth of groove (mechanical coupling)

Notes

- The factor of 1.15 is an allowance of 15% for variation in manufactured pipe wall thickness.
- The internal pressure is made up of static head due to the difference in elevation and friction losses. An additional allowance of 250 psi can be considered for surge pressure (water hammer), where applicable.
- The yield strength of common steel pipe (A53-Grade B) is 35,000 psi.

Table 20-9 Dimensions of Commercial Steel Pipe

(d = inside diameter, t = wall thickness)

PIPE Diameter (inches)	Schedule 40		Schedule 80		Schedule 160		XXS	
	t (inch)	d (inches)	t (inch)	d (inches)	t (inches)	d (inches)	t (inch)	d (inches)
2	0.154	2.067	0.218	1.939	0.343	1.689	0.436	1.503
3	0.216	3.068	0.300	2.900	0.437	2.626	0.600	2.300
4	0.237	4.026	0.337	3.826	0.531	3.438	0.674	3.152
6	0.280	6.065	0.432	5.761	0.718	5.189	0.864	4.897
8	0.322	7.981	0.500	7.625	0.906	6.813	-	-
10	0.365	10.020	0.593	9.564	1.125	8.500	-	-
12	0.406	11.938	0.687	11.376	1.312	10.126	-	-

The outside diameter (D) is equal to the inside diameter (d) plus twice the wall thickness, t

20.13 Settling Velocity

For particles of diameter less than 1mm (1,000μ), Stokes' Law applies to calculate the settling velocity in still water. For particles of diameter greater than 1 cm, Newton's Law should be used; however, this requires the calculation of Reynolds number and the determination of drag coefficients. In the transition zone, the actual settling velocity is somewhere between the two laws. For typical mine dewatering applications, Stokes' law is used and may be reduced to the following formula when dealing with water.

$$v_s = 1962 (\rho_s - 1) d^2$$

v_s = particle settling velocity in meters per hour, ρ_s = SG of the particle*, d = diameter of the particle in millimeters.

The formula can be used to determine the minimum required plan area for a vertical settler.

Example

Determine the size of vertical settler required to settle 25 μ particles at a given inflow rate of 500 USGPM.

Listed below are the required steps.

1. Determine the settling speed. Assume the S.G. of the particle is 3.0

$$v_s = 1962 \times (3.0 - 1) \times (0.025)^2 = 2.45\text{m/hour.}$$

2. Convert flow rate and determine the settling speed.

$$1 \text{ m}^3/\text{hour} = 4.40 \text{ USGPM}; \text{ therefore } 500 \text{ USGPM} = 113.6 \text{ m}^3/\text{hour.}$$

3. Determine minimum plan area of settler.

$$A = (113.6 \text{ m}^3/\text{hour}) / (2.45\text{m/hour}) = 46.4\text{m}^2 [500 \text{ ft}^2]$$

Note

$$1.0 \text{ ft}^2/\text{USGPM}$$

4. Adjust the theoretical result by 20% to account for unintentional agitation in the settler and other inefficiencies.

$$A = 1.2 \times 46.4 \text{ m}^2 = 55.7 \text{ m}^2 [600 \text{ ft}^2]$$

Solution:

A cone settler 8.4m (28 feet) in diameter

Note

Specific gravity of a fine particle is usually more than the rock from which it came, due to porosity. Particles derived from typical feldspathic hard rocks (SG =2.65) may have SG =3.

20.14 Underground Dam Design

The Ministry of Labor (Ontario) has developed a set of standards for bulkhead and dam design for underground mines. They produced tables of pre-designed criteria for use in easily choosing a design without having to perform all the calculations. This section outlines these design criteria for dams only. (The tables for bulkheads may not always be correct.)

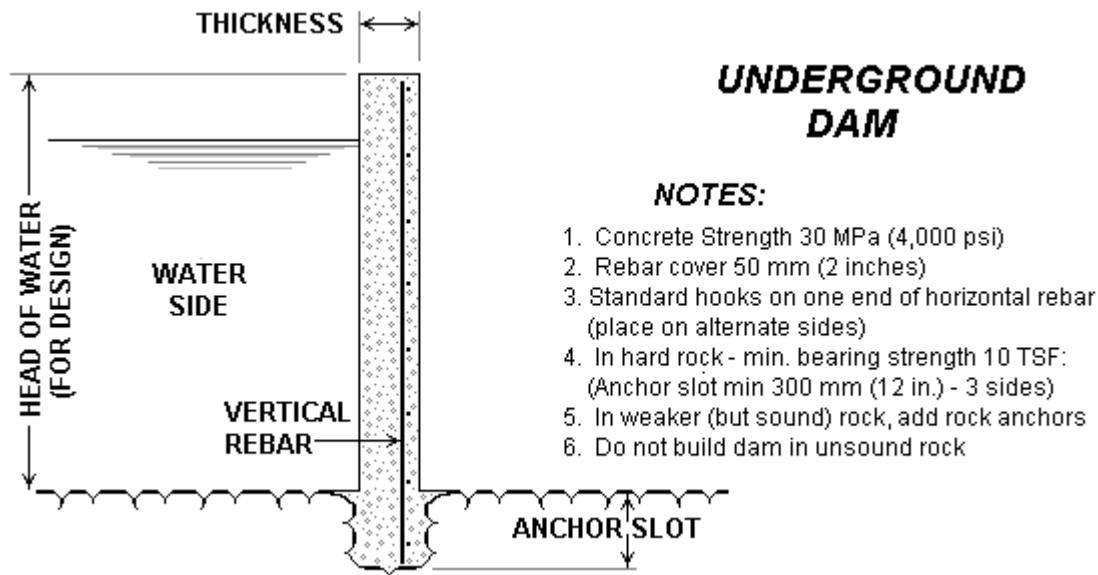

Figure 20-3 Underground Dam Design

Table 20-10 Overflow Dam Design (Metric)

Height (mm)	Width (mm)	Head of Water (mm)	Thickness (mm)	Horizontal Reinforcement	Vertical Reinforcement
2,400	2,400	2,400	300	15M @ 300	15M @ 300
3,000	3,000	3,000	300	15M @ 210	15M @ 300
3,600	3,600	3,600	350	15M @ 160	15M @ 300
3,600	4,900	3,600	400	20M @ 180	15M @ 250
3,600	6,100	3,600	500	25M @ 230	15M @ 250

Table 20-11 Overflow Dam Design (Imperial)

Height (feet)	Width (feet)	Head of Water (feet)	Thickness (in)	Horizontal Reinforcement	Vertical Reinforcement
8	8	8	12	#5 @ 12 inches	#5 @ 12 inches
10	10	10	12	#5 @ 8.5 inches	#5 @ 12 inches
12	12	12	14	#5 @ 6.5 inches	#5 @ 12 inches
12	16	12	16	#6 @ 6.5 inches	#5 @ 11 inches
12	20	12	19	#8 @ 9.0 inches	#5 @ 9.0 inches

21.0 Backfill

21.1 Introduction

Backfill is the term for material used to fill voids (empty stopes) created by mining activity.

“The reasons for putting backfill underground ... range from providing regional support to disposal of a waste product. The fill serves many functions, although it is generally considered in terms of its support capabilities. Other than its own body weight, backfill is a passive support system that has to be compressed before exerting a restraining force. Backfill has little effect on the stress distribution in the surrounding strata. It can, however, have a considerable effect on the strength of a rock structure, even if it only prevents the rock from unraveling. This allows the rock to continue support even though fractured. To maximize support, the fill should be placed as soon as possible to take advantage of wall closure (and before sloughing has progressed).”

Singh and Hedley

Function

The original function of backfill in hard rock mines was to support wall rocks and pillars and provide a working surface for continuing mining. This was first accomplished with rock fill and then with hydraulic fill (HF). If cement were added to a hydraulic backfill (30:1), the backfill provided better support for pillars and wall rocks. If enriched at the top of a pour (10:1), the backfill provided a smooth and hard surface that facilitated removal of broken ore and reduced dilution from the fill. Backfill also afforded the opportunity for more selective mining and greater recovery, including recovery of pillars, thereby increasing both mine life and total return on investment. Other functions of backfill are the prevention of subsidence and better control over ventilation flow through the mine workings. Cemented hydraulic fill (CHF) or paste backfill may be used to stabilize caved areas in the mine. Backfill is also considered an essential tool to help preserve the structural integrity of the mine workings, taken as a whole and to help avoid major rock bursts in highly stressed ground (refer to Chapter 2 – Rock Mechanics).

Application

“Fill preparation and the placement system should be both simple and efficient, and special attention must be given to the aspects of quality and quality control.”

F. Hasani and J. Archibald (Mine Backfill 1998)

The application of a backfill system may be classified into two systems.

- Cyclic Filling
- Delayed Filling

In cyclic backfilling systems, the fill is placed in successive lifts as in a Cut and Fill mining sequence. Fill in each operation cycle acts as a platform for mining equipment or mining may occur below, beside, or through the backfill.

With delayed backfill, an entire stope is filled in one pass. The fill must not only be capable of existing as a free-standing wall, but the wall must be rigid enough to withstand the effects of blasting and pulling an adjacent stope so that dilution from sloughing is minimal.

Types of Backfill

The following types of backfill employed in hard rock mines are dealt with in the text of this chapter.

- Rock fill
- Concrete fill
- Cemented Rock Fill (CRF)
- Paste fill
- HF
- Ice fill (permafrost regions)
- CHF (normal and high density)

Selection

The optimum backfilling method to be used at a proposed mine is clearly related to the mining method. If the mining method was already determined, the selection procedure is simplified. A problem remains in that the selection is often made on the basis of current technology. (When it comes to being state-of-the-art, backfill technology has a short shelf life.) A remedy is to evaluate research work now in progress, and then design a backfill system that is flexible enough to best accommodate anticipated advances in technology. For example, two new mines were designed with dual-purpose backfill plants that can deliver both paste fill and HF.

21.2 Rules of Thumb

General

- The cost of backfilling will be near 20% of the total underground operating cost. *Source:* Bob Rappolt
- Typical costs of backfill range between 10 and 20% of mine operating cost and cement represents up to 75% of that cost. *Source:* Tony Grice
- The capital cost of a paste fill plant installation is approximately twice the cost of a conventional hydraulic fill plant of the same capacity. *Source:* Barrett, Fuller, and Miller
- If a mine backfills all production stopes to avoid significant delays in ore production, the daily capacity of the backfill system should be at least 1.25 times the average daily mining rate (expressed in terms of volume). *Source:* Robert Currie
- The typical requirement for backfill is approximately 50% of the tonnage mined. It is theoretically about 60%, but all stopes are not completely filled and tertiary stopes may not be filled at all. *Source:* Ross Gowan
- It is common to measure the strength of cemented backfill as if it were concrete (i.e. 28 days), probably because this time coincides with the planned stope turn-around cycle. Here it should be noted that while concrete obtains over 80% of its long-term strength at 28 days, cemented fill might only obtain 50%. In other words, a structural fill may have almost twice the strength at 90 days as it had at 28 days. *Source:* Jack de la Vergne

Hydraulic Fill

- The quantity of drainwater from a 70% solids hydraulic backfill slurry is only one-quarter that resulting from one that is 55% solids. *Source:* Tony Grice
- Hydraulic backfill has porosity near 50%. After placement is completed, it may be walked on after a few hours and is "trafficable" within 24 hours. *Source:* Tony Grice
- It takes two pounds of slag cement to replace one Lb. of normal Portland cement. In other words, HF with 3% normal cement and 6% slag cement will exhibit the strength characteristics of one with 6% normal cement alone. *Source:* Mount Isa Mines
- Because the density of hydraulic fill when placed is only about half that of ore, unless half the tailings can be recovered to meet gradation requirements, a supplementary or substitute source of fill material is required. *Source:* E. G. Thomas

Cemented Rock Fill

- A 6% binder will give almost the same CRF strength in 14 days that a 5% binder will give in 28 days. This rule is useful to know when a faster stope turn-around time becomes necessary. *Source:* Joel Rheault
- As the fly ash content of a CRF slurry is increased above 50%, the strength of the backfill drops rapidly and the curing time increases dramatically. A binder consisting of 35% fly ash and 65% cement is deemed to be the optimal mix. *Source:* Joel Rheault
- The strength of a cemented rock backfill may be increased 30% with addition of a water reducing agent. *Source:* John Baz-Dresch
- The size of water flush for a CRF slurry line should be 4,000 US gallons. *Source:* George Greer
- The optimum W/C ratio for a CRF slurry is 0.8:1, but in practice, the water content may have to be reduced when the rock is wet due to ice and snow content of quarried rock or ground water seepage into the fill raise. *Source:* Finland Tech
- The actual strength of CRF placed in a mine will be approximately 2/3 the laboratory value that is obtained from standard 6 inch diameter concrete test cylinders, but will be about 90% of the value obtained from 12-inch diameter cylinders. *Source:* Thiann Yu

Paste Fill

- Only about 60% of mill tailings can be used for paste fill over the life of a mine because of the volume increase, which occurs as a result of breaking and comminuting the ore. *Source:* David Landriault
 - Experience to date at the Golden Giant mine indicates that only 46% of the tailings produced can be used for paste fill. *Source:* Jim Paynter
-

Paste Fill (continued)

- The inclusion of the slimes fraction (“total tails”) means that at least some cement must always be added to paste fill. The minimum requirement to prevent liquefaction is 1½%. *Source:* Tony Grice

- Very precise control of pulp density is required for gravity flow of paste fill. A small (1-2%) increase in pulp density can more than double pipeline pressures (and resistance to flow). *Source:* David Landriault

- 40% of paste fill distribution piping may be salvaged for re-use. *Source:* BM&S Corporation

21.3 Tricks of the Trade

- In general, when contemplating backfill design, the following aspects should be investigated.

<ul style="list-style-type: none"> – Geology of ore deposit, dimensions of orebody, dip, ore grade. – Physical and mechanical properties of ore and host rock-mass. – Environmental requirements. – Fill material resources. – Mining method, production capacity and operation schedule. – Fill strength requirement analysis. 	<ul style="list-style-type: none"> – Determination of fill composition based on strength analysis and available material. – Determinations of quantity of fill constituents. – Fill preparation system and facilities. – Fill placement system and related equipment. – Overall economic analysis. – Location of the stope openings relative to surface facilities.
---	---

Source: F. Hasani and J. Archibald (Mine Backfill 1998)

- The way to get a really high-density sand fill (80%+) is to use carefully selected alluvial sand and add some pure silt to obtain optimum gradation. Use only Portland cement as the binder (no fly ash or slag cement). No flocculating agent or other modifier is added. After adequate mixing, and “priming” the line with a water flush only (no compressed air), feed the mixture down an uncased borehole drilled 6 inches in diameter and makes no more than 5 gallons per minute of ground water. A larger diameter borehole is a detriment because it permits segregation. If it is done correctly, the backfill comes out of the fill line at the consistency of toothpaste and there is zero water bleed (decant). When the lateral transport underground is a considerable distance, we have to reduce the solids content to 76% to maintain an adequate gravity head. *Source:* Crean Hill Mine
- The coarse particles within cemented rock fill tend to migrate away from the impact area(s). This segregation forms weak layers in the stope that may cause stability problems when the adjacent blocks are later mined. Proper orientation of the fill delivery systems into the stope (raises, etc.) is vital for producing effective rock fill. *Source:* S. Peterson, J. Szymanski, and S. Planeta
- Free-fall of paste or hydraulic fill in a vertical pipe column is unacceptable, but the principal of free-fall can be employed to advantage under certain circumstances. If ground conditions are suitable, using an unlined borehole as the main vertical delivery pipeline is possible. In this case the high wear rates and high impact pressures do not present a problem. *Source:* A.J.C. Patterson, R. Cooke, and D. Gericke
- When a cemented fill cures in the stope, the binder cements absorb almost an equivalent mass of water in the hydration reaction. For a paste fill, this removal produces an unsaturated fill with potentially advantageous negative pore pressure. *Source:* Barrett, Fuller, and Miller
- Installation of rupture devices at key points in a paste fill distribution network will protect against over-pressure caused by line blockage. A rupture device consists of a machined pipe section with housing and downspout to direct the flow of material when failed. *Source:* BM&S Corporation
- Pressure sensors installed at key elevations are of great assistance in evaluating impact of process changes and determining the location of a blockage in a paste fill pipeline network. Either diaphragm-style or strain gage sensors may be employed. *Source:* BM&S Corporation
- A paste fill pour should be preceded with a water flush and followed with a water flush followed by a water/compressed air flush. *Source:* BM&S Corporation
- The quality control for the paste mixture should include amperage measurement on the mixer drive motor. The amperage draw is proportional to the viscosity of the mixture. *Source:* Fred Brackebush

- A stope raise is normally required when employing sublevel retreat. This can be avoided by placing Styrofoam® blocks suspended with wire ropes against the ore wall when backfilling with cemented rock fill. For paste fill, we drill a hole in the fill near the wall with a production rig soon after placement and back ream it to 24 inches diameter. This procedure is even less expensive than the Styrofoam®. *Source: Jacques Perron*

21.4 Types of Backfill

Rock Fill

Originally, backfill consisted of waste rock from development and hand picked from broken ore. Some of the larger mines in the USA quarried rock and dropped it down fill raises to the mine workings. Filling with rock alone is seldom practiced today except for filling tertiary stopes.

Cemented Rock Fill

CRF originally consisted of spraying cement slurry or CHF on top of stopes filled with waste rock (Geco and Mount Isa). The method was based on a civil engineering procedure known as Prepakt® that was already employed in the construction of concrete dams and bridge piers. Today, a cement slurry is added to the waste rock before (or as) the stope is filled. In most cases, rock is quarried on surface and dropped to the mining horizon through a fill raise. Trucks or conveyors are used for lateral transport underground.

The advantages of CRF include a high strength to cement content ratio and provision of a stiff fill that contributes to regional ground support. CRF is still selected for some new mines and many operators prefer this system.

A variation employed at Mount Isa shows promise – CHF replaces the cement slurry. The improved gradation of the resulting mixture is believed to be responsible for obtaining high strength (1.5 MPa at 28 days) with very little cement binder. Following is the recipe for the fill used at Mount Isa.

- 1% Normal Portland Cement
- 2% Slag cement
- 30% HF
- 66% Rockfill

Olympic Dam uses a comparable backfill in which fly ash replaces a portion of the normal cement (instead of slag cement). Mill tails (de-slimed and dewatered) are directed to a pug mill where the binder and rock aggregate are mixed in to produce the hybrid backfill.

Hydraulic Fill

The first hydraulic fills consisted of a portion of the mill (concentrator) tailings that would otherwise have been deposited on surface. The mill tailings were cycloned to remove fines (slime fraction) so that the contained water would decant. This fill was transported underground as slurry, hence the term "hydraulic fill." Initially, HF was sent underground at approximately 55% solids, since this is the typical underflow from a thickener and the pulp density normally used for tailings lines. When the grind from the mill was too fine for decanting in the stopes, alluvial sand was employed instead of tailings. This type of HF is often called sand fill. Particles of alluvial sand are naturally rounded enabling a higher solids content to be pumped than HF made from cycloned tailings. (The cyclone is discussed in Chapter 26 – Mineral Processing.)

Many mines still employ non-cemented HF, particularly for filling tertiary stopes.

Cemented Hydraulic Fill

Portland Cement (binder) added to hydraulic fill provides strength. Later, it was found economical to replace a portion of the cement with fly ash (pozzolan) and occasionally a portion was replaced with ground slag, lime, or anhydrite. Normal (and high-density) CHF is employed at many hard rock mines worldwide.

If cement is added to a hydraulic backfill at a ratio of 30:1, the backfill provides better support for pillars and wall rocks. If enriched at the top of a pour (10:1), the backfill provides a smooth and hard surface that facilitates removal of broken ore.

The addition of cement reduces dilution from the fill. It also affords the opportunity for more selective mining and greater recovery, including recovery of pillars.

One of the main problems with hydraulic fill and CHF is the requirement to bleed (decant) excess water from the filled stope. The dirty decanted water, along with flush water, picks up slimes and transports them to the mine sumps. The decant from CHF may contain particles of fresh cement (not yet hydrated), which has been blamed for causing hang-ups in ore passes. For these reasons, miners have directed attention towards producing HF with less contained water. As a result of these efforts, many mines were able to increase the solids content to 65 -75% and more (hence the term "high-density fill").

Widespread research has been directed at completely eliminating the bleed water from high-density cemented hydraulic fill. Most of the investigations involve applying two additives that react with each other to produce a hydrophilic silica or silicate.

An alumino-silicate reagent developed in China is reported capable of solidifying hydraulic backfill with solids content as low as 50%.

Another one is a promising system that is now commercially available. The requirement for stiff backfill in South African mines resulted in the development of Fillset[®] by Fosroc (Pty) Limited. This two-component additive allows backfills with free water present to be placed in stopes with negligible resulting run-off or drainage of free water.

The first component (which is supplied in a powder form and known as Fillcem) is added at the backfill plant along with the powdered binder. The second component (Fillgel) is in a liquid form (sodium silicate) and is injected into the backfill piping at the stope being backfilled. In the case of classified tailing fills, the use of Fillset[®] eliminates the need for in-stope backfill drainage systems and lessens the load on the mine settling/dewatering system. In the case of total tailing fills, the use of Fillset[®] allows the backfill to be transferred to the stopes in a high-density slurry form rather than a paste form, without the requirement for large binder addition rates. The Fillset[®] system has the disadvantage of requiring the Fillgel to be transported underground and added at the stope as it is backfilled.

Concrete Fill

Cement-rich (1:2 cement to solids ratio) HF was once used for mats where poor ground conditions dictated undercut-and-fill mining. Since the major cost component of backfill is the cement, this fill is not economical. To make the mats less expensive, the mats were then made from ready-mix concrete, which has 10-12% cement content for a standard 3,000-psi (20 MPa) mix. In some cases, the pour was completed above the mat with weak ready-mix concrete produced from the same batch plant. A similar procedure is practiced today at mines in Nevada and elsewhere.

Paste Fill

At the Grund mine in Germany, the "paste fill" system was first developed. The ready-mix concrete required for undercut-and-fill mining was replaced with a cemented fill using mill tails that did not require cycloning ("total tails"). The first paste fills contained a coarse aggregate fraction (sink-float product), similar to a regular concrete mix, which permitted transport at very high solids content ($\pm 88\%$) and resulted in high strengths with respect to the amount of cement. Cement was added at the stope entry. Today, paste fill is used to replace hydraulic fill without benefit of the coarse aggregate fraction and with cement mixed in before transporting underground.

The distinction between paste fill and high-density fill is an item of contention. In general, a high-density fill has the properties of a fluid while paste fill has the physical properties of a semi-solid.

Some cement must always be added to paste fill (to prevent liquefaction) even if it is to be placed in tertiary stopes that will not be exposed to subsequent mining.

Today, paste fill is found desirable for many mining methods. In North America, paste fill is often the default selection when planning for new mining projects and, in a number of instances, was installed at older mines to replace or supplement an existing backfill system. While the paste fill method is generally considered "process-proven," there are at least three instances where it proved unsuccessful in application (Dome, El Indio, and Elura). Moreover, it is generally considered the least "user-friendly" of all the methods.

An interesting variation (under research) is to agglomerate and cure a portion of the paste fill. The hardened pellets are then added to the regular mix. The result is a higher strength fill due to the improved gradation of the mixture.

Ice Fill

Ice has long been proposed as backfill in permafrost regions; however, to date, ice has only been used in Norway and the CIS (Russia).

Other Types of Fill

Other sorts of backfill are occasionally employed (e.g. smelter slag), but none have gained wide acceptance to date.

21.5 Properties

Table 21-1 shows the typical properties of structural backfills.

Table 21-1 Typical Properties of Structural Backfills

Backfill	Density kg/m ³	Binder Content Cement + Ash	Water Content	Water Bleed	UCS MPa	Max Open Height
Concrete	2,400	11%	5%	0%	20	-
CRF	1,900	5-6%	4 -4½%	0%	2-4	90m
Paste	2,000	3-6%	8 -21%	0 - 10%	0.7-3.0	60m
H Density	1,900	4-8%	25 -35%	0 - 15%	0.3-0.7	45m
CHF ¹	1,800	3-5%	35 -45%	5 - 25%	0.2-0.4	20m
Ice	917	-	100%	0%	1.0	-

¹ Cemented hydraulic backfills have a wide variety of properties, dependent upon their application, as shown in Table 21-2.

Sources: Sprott, Bawden, Moss, Yu, Farsangi, Reshke, and Moerman

Table 21-2 shows the typical properties of hydraulic, cemented backfills.

Table 21-2 Typical Properties of Hydraulic, Cemented Backfills (CHF)

Cement/Solids Ratio	Strength (28 days)	Strength (28 days)	Application
1:5	3.80 MPa	550 psi	Chute Backing
1:6	3.10 MPa	450 psi	Flooring
1:7	2.40 MPa	350 psi	Flooring
1:8	1.70 MPa	250 psi	Flooring
1:10	1.40 MPa	200 psi	Flooring
1:20	0.60 MPa	85 psi	Bulk Fill
1:30	0.40 MPa	55 psi	Bulk Fill
1:40	0.30 MPa	40 psi	Bulk Fill
1:50	0.14 MPa	20 psi	None

21.6 Case Histories

Tables 21-3 and 21-4 provide case histories for paste fill and CRF.

Table 21-3 Paste Fill Case Histories

Mine	Location	Binder Content	Plant Capacity	% Solids	Fill Strength	Transport Method	Pipe/Bore- hole Diameter
Bad Grund ¹	Germany	4%		88%	1.5-2 MPa	Pump	150mm
Bad Bleiberg	Austria	6-7%			2-3 MPa	Gravity/ Pump	140mm
Lucky Friday ¹	Idaho	6%	120 tph			Gravity	150mm
Garson	Ontario	3%	200 tph	82%		Gravity	200mm (B/H)
Creighton	Ontario		400 tph	79%		Gravity	150mm (B/H)
Lupin	NWT		100 tph	80%		Gravity	150mm
Aur	Quebec	4.5%	175 tph	80%		Gravity/ Pump	200mm (B/H)
Chimo ¹	Quebec		65 tph	83%		Gravity	
Bouchard Hebert	Quebec		90 tph				150mm (B/H)
Polaris	NWT						
Macassa ¹	Ontario		150 tph			Gravity	300mm (B/H)
Cannington	Australia		100 m ³ /h				
McCreedy	Ontario					Gravity	150mm (B/H)
BM&S	N. B.	5%	360 tph			Gravity	200mm (B/H)

¹ Mine now closed

Table 21-4 Cemented Rock Fill Case Histories

Mine	Location	Binder ¹ Content	Daily Tonnage Placed	W/C Ratio of Slurry	Fill Strength 28 days	Rock Source	Transport Method U/G
Mount Isa	Australia	C-3%, Slag 9%	6,100				Conveyor
Kidd Creek	Ontario	5-6% (C+FA)	4,000	0.8:1	2-4 MPa	Quarry	Conveyor
Brunswick	N B		2,100			Quarry	Conveyor
Williams	Ontario	C3 ½ %, FA1½%	4,200	0.8:1	3-4 MPa	Pit Waste	Conveyor
Ansil	Quebec	4% (C)	1,200			Waste	LHD
Bousquet #1	Quebec	5% (C+ FA)	800				Truck
Birchtree	Manitoba	5% (C)	900			Waste	LHD/Truck
Meggen	Germany	3% (C)	1,400	Added dry	1 MPa	Waste, HM	Slinger Belt
Jerrit Canyon	Nevada	C 5.2%, FA1.3%	1,350		7.5 MPa	Pit Waste	Truck/ Jammer
Cannon	Washington	C 5-6%	3,000			Pit Run	Truck
Nome Lake	Manitoba	C3 % FA2 %	900	0.73:1	1-2 MPa	Quarry	Truck
Musselwhite	Ontario	C 2½ % FA 2½%	1,500	1:1		Waste pile	Truck

¹ (C = cement, FA = fly ash)

21.7 Cooling from Paste Fill

When considering air conditioning for a hot mine, the cooling effect of backfill is taken into account in the heat balance computation. A common misconception is that the heat of hydration of the cement in the fill adds to the heat load of the mine; however, in most cases, this heat is not sufficient to warm the backfill up to the virgin rock temperature.

Following is a sample calculation to determine the amount of cooling provided by a typical paste fill mixture.

Example

		Winter	Summer
Facts:	1. Average delivery temperature of paste fill:	45°F	60°F
	2. Average VRT ¹ at mining horizon:	90°F	90°F
	3. Temperature rise:	45°F	30°F
	4. Specific heat of H ₂ O =	1.00 Btu/lb.·°F	
	5. Specific heat of solids =	0.23 Btu/lb.·°F	
	6. Heat of hydration of cement:	90 cal/gram = 162 Btu/lb.	
	7. Average cement content of fill:	3.5% by weight	
	8. Average total solids content of fill:	84% by weight	
	9. Average water content of fill:	16% by weight	
	10. Application rate:	7 days per week = 1,600 tpd	

Solution:

Total cooling per day (24 hours under summer conditions):

Water = 1,600 × 2,000 × 0.16 × 1.00 × 30 =	15,360,000 Btu/d
Solids = 1,600 × 2,000 × 0.84 × 0.23 × 30 =	<u>18,547,000 Btu/d</u>
	33,907,000 Btu/d

Less heat of hydration of cement:

Cement = 1,600 × 2,000 × 0.035 × 162 =	<u>18,144,000 Btu/d</u>
--	-------------------------

Net cooling per day =	15,763,000 Btu/d
-----------------------	------------------

Net cooling rate = 15,763,000 / (24 × 60) =	10,950 Btu/min
---	----------------

¹ VRT = virgin rock temperature

22.0 Explosives and Drilling

22.1 Introduction

Explosives and drilling are combined into one chapter because blasting in hard rock mines normally involves placing explosives into boreholes (blastholes) drilled in rock.

Commercial explosives are mixtures of chemical compounds in solid or liquid form. Detonation transforms the compounds into other products, mostly gaseous. This action is exothermic, producing heat that further expands the gases and causes them to exert enormous pressure in a blasthole in addition to producing a stress wave. The combination of these two effects (borehole pressure and detonation wave) breaks the rock surrounding a blasthole.

From its crude beginning centuries ago, blasting has become an advanced science that is now far more comprehensive than can be adequately addressed in this handbook. Practice in hard rock mines is continually changing due to technical advances as well as increasing concern with safety, security, and the environment.

This chapter is intended to provide some useful data for the hard rock miner while avoiding details of implementation. The information provided in the text is limited to certain aspects of blasting that are of particular concern in today's hard rock mines. These include crater blasting, sulfur blasts, drilling equipment and drill patterns. The reader desiring additional information may refer to Gary Hemphill's book, "Blasting Operations," McGraw Hill, ISBN 0-07-028093-2 and valuable material published by the various powder companies as a service the mining industry.

In conformity with the format established for the rest of this handbook, sections devoted to rules of thumb and tricks of the trade precede the text of this chapter.

22.2 Rules of Thumb

Powder Consumption

- Listed below is typical powder consumption in hard rock.
 - Shaft Sinking – 2.5 Lb./short ton broken
 - Drifting – 1.8 Lb./short ton broken
 - Raising – 1.5 Lb./short ton broken
 - Slashing – 0.8 Lb./short ton broken
 - Shrink Stope – 0.5 Lb./short ton broken
 - O/H Cut and Fill – 0.5 Lb./short ton broken
 - Bulk Mining – 0.4 Lb./short ton broken
 - Block Cave u/c – 0.1 Lb./short ton to be caved
 - Open Pit Cut – 0.9 Lb./short ton broken
 - Open Pit Bench – 0.6 Lb./short ton broken

Various Sources

Explosive Choice

- The strength of pure ammonium nitrate (AN) is only about one-third as great as that of an oxygen balanced mixture with fuel oil (ANFO). *Source:* Dr. Melvin Cook

Blasting Strength

- Blasting strength is a direct function of density, other things being equal. Typical explosives for dry ground (ANFO) may have a blasthole density (SG) of 0.8 to 1.3, while for wet ground (slurry or emulsion) it varies from 1.1 to 1.3. Developments in explosive technology make it possible to choose any density desired, within the given ranges. *Source:* Dr. Nenad Djordjevic

Spacing and Burden

- For hard rock open pits or backfill rock quarries, the burden between rows can vary from 25 to 40 blasthole diameters. Spacing between holes in a row can vary between 25 and 80 blasthole diameters. *Source:* Dr. Nenad Djordjevic
 - The burden can vary between 20 and 40 blasthole diameters. Light density explosives require a ratio of 20-25:1. Dense explosives require 35-40:1. *Source:* John Baz-Dresch
-

Spacing and Burden (continued)

- To obtain optimum fragmentation and minimum overbreak for hard rock open pits or backfill rock quarries, the burden should be about one-third the depth of holes drilled in the bench. *Source:* Dr. Gary Hemphill
- To obtain optimum fragmentation and minimum overbreak for stripping hard rock open pits or quarrying rock fill, the burden should be about 25 times the bench blasthole diameter for ANFO and about 30 times the blasthole diameter for high explosives. *Source:* Dr. Gary Hemphill
- The burden required in an open pit operation is 25 times the hole diameter for hard rock, and the ratio is 30:1 and 35:1 for medium and soft rock, respectively. The spacing is 1 to 1.5 times the burden and the timing is a minimum of 5 ms (millisecond) per foot of burden. *Source:* John Bolger
- The burden and spacing required in the permafrost zones of the Arctic is 10-15% less than normal. *Source:* Dr. Ken Watson
- When "smooth wall" blasting techniques are employed underground, the accepted standard spacing between the trim (perimeter) holes is 15-16 times the hole diameter and the charge in perimeter holes is 1/3 that of the regular blastholes. The burden between breast holes and trim holes is 1.25 times the spacing between trim holes. *Source:* M. Sutherland

Collar Stemming

- The depth of collar for a blasthole in an open pit or quarry is 0.7 times the burden. *Source:* John Bolger
- The depth of collar stemming is 20-30 times the borehole diameter. *Source:* Dr. Nenad Djordjevic
- For open pits or back-fill rock quarries, pea gravel of a size equal to 1/17 the diameter of the blasthole should be employed for collar stemming (i.e. ½ inch pea gravel for an 8½-inch diameter hole). *Source:* Dr. Gary Hemphill

Relief Holes

- Using a single relief hole in the burn cut, the length of round that can be pulled in a lateral heading is 3 feet for each inch diameter of the relief hole. For example, a 24-foot round can be pulled with an 8-inch diameter relief hole. *Source:* Karl-Fredrik Lautman
- It has been found that a relief hole of 250mm (10 inches) will provide excellent results for drift rounds up to about 9.1m (30 feet) in length. *Source:* Bob Dengler

Blastholes

- The optimum blast hole diameter (in inches) is equal to the square root of the bench height measured in feet. For example, a 7-inch diameter hole is desired for a 50-foot bench. *Source:* William F. Cahoon
- The cost of drilling blastholes underground is about four times the cost of loading and blasting them with ANFO. Present practice is usually based on the historical use of high explosives where the costs were about equal. An opportunity exists for savings in cost and time for lateral headings greater than 12 feet by 12 feet in cross-section by drilling the blastholes to a slightly larger diameter than is customary. *Source:* Jack de la Vergne
- The "subdrill" (over-drill) for blastholes in open pits is 0.3 times the burden in hard rock and 0.2 times the burden in medium/soft rock. *Source:* John Bolger
- The "subdrill" is normally 0.3 times the burden and never less than 0.2. *Source:* John Baz-Dresch
- "Sub-grade" (over-drill) is in the order of 8 to 12 blasthole diameters. *Source:* Dr. Nenad Djordjevic

Noxious Fumes

- The heavier the explosive confinement, the lower the production of NO and NO₂ for any blasting agent. Excess fuel in ANFO (8% FO) is as good as any additive (with regular ANFO) in reducing NO₂ formation. *Source:* Sapko, Rowland et al

Ground Vibration

- The ground vibration produced by the first delay in a burn cut round is up to five times higher than that generated by subsequent delays well away from the cut. *Source:* Tim Hagan
-

Crater Blasting

- Crater blasting will be initiated if the charge acts as a sphere, which in turn requires the length of a decked charge in the blasthole to be no more than six times its diameter. *Source:* Mining Congress Journal

Labor Cost

- The labor cost for secondary blasting can be expressed as a percentage of the labor cost for primary mucking. For Sub-Level Cave and Crater Blasthole stoping, it is around 30%; for Sub-Level Retreat it is closer to 10%. *Source:* Geoff Fong

Drilling

- Percussion drilling is required for drilling blastholes in rocks with a hardness of 4 or greater on the Mohs' scale (refer to Chapter 1). These are mainly the volcanic rocks. Rotary drilling is satisfactory for softer rocks, mainly sedimentary. *Source:* Dr. Gary Hemphill
 - The number of drill holes required in a lateral heading, $N = \text{Area}/5 + 16$. For example, a 10-foot x 15-foot heading requires 46 holes. (Use $N = 2.2 \times \text{Area} + 16$ for metric units.) A few more holes are required if perimeter drilling is to be employed. *Source:* Tim Arnold
 - A one-degree adjustment in dip will displace a longhole one foot for each 60 feet drilled from the collar. *Source:* Shawn O'Hara
-

22.3 Tricks of the Trade

- To achieve optimum fragmentation in hard rock mining, the explosive of choice is usually that with the highest detonation velocity and the maximum available energy density. *Source:* Dr. Melvin Cook
- The way to have your blasting pattern designed for a particular application is to ask your friendly local powder agent to do it for you. This service is usually performed promptly and without charge. *Source:* Reid Watson
- The way to teach new hands to drive a burn cut drift is to start with a short round. Have them drill and blast only the cut until they do it correctly. Then, let them drill and blast a whole round at once. When they have mastered the short round, they are ready to try a full round. *Source:* Marshall Hamilton
- The average fragment size increases and the uniformity of fragmentation decreases when the depth of charge (burial distance) increases. *Source:* Liu and Katsabanis
- Collar priming generally produces a high muck pile close to the bench face. Bottom priming spreads out the muck pile. *Source:* John Baz-Dresch
- If the length of blastholes is equal to that of the relief holes in a burn cut round, the free face for the explosive at the toe of the blastholes is limited. If the relief holes are drilled a foot longer than the blastholes, the result will be less bootleg. *Source:* Tim Hagan
- The accuracy of delay timing in commercially available caps is sometimes insufficient to ensure proper sequence. A simple way to overcome this problem is to use only alternate delays (i.e. 0, 2, 4, 6, etc. instead of 0, 1, 2, 3, 4, etc.). *Source:* Tim Hagan
- Inserting a plastic sleeve right after drilling a blasthole in permafrost overburden will prevent it from becoming choked with ice build up before it can be loaded with explosives. The procedure is also beneficial in some bad ground conditions. *Source:* Jim Tucker
- Button bits normally give higher penetration rates but are more prone to deviation in long holes than cross bits. *Source:* Tamrock
- For long hole drilling, thread reversing, and redistributing the rods in the drill string, considerably prolongs life of drill rods. *Source:* Tamrock
- Any surface concrete structure designed for a new mine (or added to an existing mine) should include plastic pipe inserts suitable for loading explosives to facilitate ultimate demolition. *Source:* Peter R. Jones
- On surface, the contract specifications may require a delay of seven days before blasting near freshly poured concrete because the set may be disturbed by vibration. This is not the case underground when concrete is poured against hard rock. In many cases, nearby blasting has been carried out within 6-8 hours of a concrete pour with no ill effect. *Source:* Jack de la Vergne

- Steel reinforcing (rebar) can be salvaged from concrete members being demolished by drilling short holes and setting off small charges with the same delay. This procedure vibrates the steel, which cracks the cover. The cover concrete is then easily scaled off to reveal the rebar cage. *Source:* John Newman

22.4 Explosive Selection and Types

Following are the main criteria applied to select an explosive for a given type of blasting.

- Available energy per unit weight of explosive
- Density of the explosive
- Detonation velocity
- Reaction rate
- Explosive Types

Following are the more common explosives used in the hard rock mining industry.

ANFO

ANFO is the most prevalent explosive used in the mining industry because it is the least expensive and the safest to transport and handle. Standard ANFO is defined as a mixture of prilled AN having 1% inert coating and 5.7% No.2 diesel Fuel Oil as a reducing agent. This combination results in a product with a density of 0.84 and an oxygen balance of -0.5% ($\frac{1}{2}\%$ by weight oxygen deficient).

Typical operating densities range from 0.8 to 1.2 g/cm³. Packing or crushing AN prills will alter density (and sensitivity). It will also reduce the emission of noxious fumes. Energy output and sensitivity are both affected by the oxygen balance (stoichiometry) of the mixture. ANFO type explosives are susceptible to water and, therefore, not suitable for wet blastholes. ANFO explosives may also pose an environmental dilemma resulting from their high nitrate content.

Slurries (Water Gels)

Due to the susceptibility of ANFO products to water, slurries were developed to replace ANFO in wet conditions. AN was dissolved in water and mixed with a fuel (in this case another oxygen deficient explosive, such as TNT) and surrounded by gum to produce a water-resistant explosive. The result was a product with higher bulk strength than ANFO suitable for use in wet conditions. The disadvantages of slurries include higher cost, unreliable performance, and deterioration with prolonged storage.

Emulsions

Emulsions were developed to overcome the main disadvantages of slurries. Emulsions consist of a continuous (oxidizer) phase and a discontinuous (fuel) phase combined using an emulsifier and a bulking agent, such as micro-balloons. They can be kicked-up with powdered aluminum. Emulsions have high energy, reliable performance, resistance to water, and relative insensitivity to temperature changes. The direct cost of an emulsion explosive is higher but this is offset by time saved in loading and a reduction in nitrate content of broken muck.

Dynamites

Dynamites are explosive mixtures made of nitroglycerin made stable by dissolving it in an inert bulking agent. The employment of dynamites has greatly diminished because of high cost and higher risk in transport and handling. Dynamites are still used for certain applications, such as shaft sinking with hand-held machines.

22.5 Crater Blasting

Crater blasting techniques (VCR[®], MVCR, HCR, and HRM) are often employed for larger underground ore bodies in hard rock mines stoped with bulk mining methods. (Refer to Chapter 3 – Mining Methods for additional information.) Crater blasting has been used successfully for drop raises and even for shaft sinking. No real success has been achieved using crater blasting for lateral headings.

Crater blasting is based on the theory that a short stubby (spherical) powder charge will break more hard rock than a long thin cylindrical charge of the same weight. A spherical charge enables better use of the detonation wave than the cylindrical. The cylindrical charge mainly depends on the expansion of gases generated by the explosion (bubble effect). In theory, the volume of rock shattered by the detonation wave is proportional to the square of the detonation velocity. Based on this theory, explosives with high detonation velocities are employed, such as dense slurries that may have a detonation velocity 50% higher than normal.

Any blasting is more effective when it takes full advantage of gravity. Therefore, the blasting method will be more efficient if the back is blasted down in horizontal slices to the opening below. Following this procedure eliminates the requirement for a slot raise and best allows for the practice of leaving broken ore in the stope while pulling only the swell ("deferred pull"). The technique is often modified to employ a slot raise and take blocks or vertical slices with each blast instead of the classic

horizontal slice. The vertical slice means blastholes are only used once; therefore, less likely to require re-drilling. Vertical slices also avoid the problem of blasting the last horizontal slice. In theory, the vertical slice provides both a horizontal and vertical free face. Experiments at the Battelle Institute indicate that a larger crater results when a second face is available. A disadvantage to vertical slicing is that the broken ore next to the fresh face must be pulled clean before the next round is blasted. This makes it difficult to leave broken ore in the stope for support (i.e. “deferred pull”).

Employing the indexing theory may provide further efficiency. The indexing theory postulates that the common crater created by two or more adjacent craters is larger than the sum of separate, single crater blasts. This indicates that the method will be most effective if a whole slice or block is blasted at once.

22.6 Sulfur Blasts

A sulfur blast is a subsequent air blast detonated by the combustion of sulfide dust produced from an underground blast. Sulfur blasts typically produce large quantities of noxious sulfur dioxide gas. Sulfur blasts are not uncommon in base metal mines and may be more severe where crater blast techniques are employed with large diameter blastholes. They are more frequent in development headings where the use of millisecond delays is not practical. In theory, the flame from late delays ignites the cloud of fine dust particles from initial delays. The phenomenon is believed to occur through ignition and exothermic roasting of sulfide dust particles enhanced by the addition of more dust swept up by the initial propagation.

Employing the following practices can reduce the frequency and severity of sulfur blasts.

- Use explosives with a low detonation temperature
- Use explosives with good oxygen balance
- Practice fogging and washing down
- Suppress dust with lime or limestone dust (as in a coal mine)
- Provide adequate collar stemming of blastholes
- Practice stemming with limestone and decking with limestone dust in bags
- Practice popping a bag(s) of limestone dust with half a stick at zero delay
- Blast between shifts and on weekends when the mine is evacuated

22.7 Drilling Blastholes

To be economical, blastholes drilled in hard rock require drilling equipment capable of both rotation and percussion. Holes could be drilled with good progress using a rotary drill and tri-cone bit, but the bit life would be too low. Diamond drills (that also have only rotation) drill with good progress; however, the bit cost and the amount of energy required to be transferred to the bit (that grinds to dust rather than chips) are too high. Consequently, miners normally employ rotary-percussion drills in hard rock formations.

Two basic types of rotary-percussion drills exist: (1) top-hammer and (2) ITH. This nomenclature is based on which end of the drill string the drill is located. In general, hard rock miners use top hammer drills for holes less than 4 inches (150mm) in diameter, and ITH drills for larger holes.

Miners still use blade bits (chisel or cross) for drilling small diameter blastholes in hard rock; button bits are normally more economical in the larger diameters.

Wet drilling has a slower penetration rate than dry drilling, but underground drilling requires water for dust suppression. This is an acute problem for mines in arctic regions where a brine solution is required to avoid freezing. One arctic mine employs dry drilling underground. Efforts to duplicate the system elsewhere have so far been thwarted, mainly because of silica content in the ore.

22.8 Drill Patterns

V-Cut

The V-cut, also called “wedge,” “cone,” and “pyramid,” is typically drilled at an inclination of 30 degrees from the drive axis.

The burn cut (described below) superseded the V cut as the standard drill pattern for development headings. Occasionally, a good application arises for the V-cut round. An example is when the muck is “thrown” from an entry portal on a mountain or steep hillside. Benching (a type of V cut) still has application for shaft sinking, especially in bad ground. At small mines in some developing countries, the V-cut prevails for lateral headings, despite great efforts to change old habits.

Burn Cut

The burn cut is preferred because it permits longer rounds and better fragmentation. The disadvantage is that it requires careful attention in the design and execution of the drill and blast pattern. The key to a successful burn cut round is the cut itself. The first cut holes (relief holes) are not loaded. These holes and immediately surrounding loaded holes (primary holes) must be drilled precisely parallel.

In a lateral heading, it is typical to have two or three central relief holes drilled and reamed. The optimum drill and blast pattern for the cut (and the whole round) may not be predictable in advance since it is dependent upon the actual ground conditions. The pattern also depends on the miners. Often, different crews on the same heading have separate patterns for the same round. Good miners may employ one or two reamed cut holes, while the less able may need three.

In small headings (jackleg or long-tom), after the first cut hole is drilled but not yet reamed, the miner uses a loading stick to align the adjacent holes parallel. Alternatively, the miner leaves the longest steel in the hole and retracts it to line up the drill. In a large lateral heading, a drill jumbo is employed incorporating a mechanism to automatically line up the steel to drill parallel holes.

Big-Hole Burn Cut

The big-hole burn cut occasionally employed for hard rock mining was first developed in the USA and Europe. The landmark application was used in driving the Granduc tunnel in British Columbia that achieved a world record advance rate (up to 115 feet per day). At Granduc, a separate GD 133 top-hammer drill was employed to drill a single 6-inch diameter central relief hole in one pass with a bull bit. More recently, ITH drills have been employed to drill 8 and 10-inch diameter relief holes in lateral headings to achieve longer rounds. For long rounds, design and execution of the cut is even more critical.

While long rounds are obviously desirable, maintaining a cycle is equally important. A regular cycle must be achieved to ensure consistent good footage. Another problem is that drill steel tends to wander in long holes. For example, even 1½-inch (38mm) jumbo steel can be a problem after about 20 feet (6m) in hard rock without stabilization.

In recent years, big-hole burn cuts have been applied to shaft sinking, employing ITH drills. Originally, big-hole burn cuts were used with two or three 6-inch relief holes and then with one or two 8-inch diameter holes or a single 10-inch hole. The problem of cleaning cuttings and water remaining in the large holes was overcome by drilling the holes 2 feet deeper or rifling the cuttings and water with a half stick on the first (zero) delay.

An important dimension is the radial distance, C , between the edge of a relief hole and the primary blastholes. The maximum allowable distance can be estimated using the following formula.

$$C = \frac{D}{2} \left(\frac{1}{\sin \frac{\theta}{2}} - 1 \right) - \frac{d}{2} \left(\frac{1}{\sin \frac{\theta}{2}} + 1 \right)$$

In which, D is the diameter of the relief hole
 d is the diameter of the blasthole
 θ is the crater angle measured in degrees

If θ is assumed at a reasoned value of 30 degrees, the equation reduces to

$$C = 1.43 D - 2.43 d$$

Example

Determine the furthest distance a primary blasthole can be placed from a relief hole and still achieve good propagation.

- Facts:
1. The primary blasthole is 1½ inches in diameter
 2. The relief hole is 8 inches in diameter
 3. The crater angle is 30 degrees

Solution: $11.4 - 3.6 = 7.8$ inches

(In practice, the primary blastholes would be collared at a distance of about 4 inches from the relief hole, to allow for deviation.)

23.0 Electrical

23.1 Introduction

The interface between the miner and electrician requires an exchange of knowledge and good communications. For this purpose, the miner needs to understand the basic principles, use, and control of electricity. This chapter is intended only as a primer to a field of work that is far more extensive than can be adequately addressed in one chapter.

The main function of electricity in a mine is to provide mechanical energy to perform useful work. Miners think of electricity in terms of energy ("it takes 300 HP to start that 100 HP motor") while electricians think in terms of amperage and voltage ("The draw of current at full load of 100 Amps for that 100 HP motor will increase to 350 Amps when started").

The cost of electrical power for an underground mine may be 10% or more of the mine operating cost; therefore, efficient use warrants scrutiny by all concerned.

The miner's role in designing a proposed power system is to accurately describe the location and size of electrical equipment to be employed and provide details of planned future relocations and possible expansion of operations. Without this information, an electrical specialist cannot design an efficient and effective system.

23.2 Rules of Thumb

Power Consumption

- The power consumption for a typical open pit mine, including the concentrator (mill) will be approximately 60 kWh per tonne of ore mined and processed. While that of a typical underground mine including the concentrator will be approximately 100 kWh per tonne. *Source:* Jack de la Vergne
- The scale up factor for the power requirement at an underground mine is 1.85 for a doubling of mine capacity. *Source:* Jack de la Vergne
- Good demand factors for power systems range from 0.7 to 0.8, depending on the number of operating sections in the mine. *Source:* Morley and Novak
- The power consumption for a concentrator (mill) can be roughly approximated by adding 15 kWh/tonne to the Bond W_i of the ore (determined by laboratory testing). *Source:* Jack de la Vergne
- To estimate annual power cost for shaft horsepower, divide the hourly cost by 3 and multiply by 20,000. For example, a typical rate of \$0.075/kWh equates to approximately \$500/HP-year. *Source:* Dave Hamel
- Power consumption (energy portion of utility billing) for a mine hoist approximately 75% of RMS power equivalent. *Source:* Unknown
- Power consumption (external work) for a mine hoist is 1 kWh/tonne for each 367m of hoisting distance at 100% efficiency (no mechanical or electrical losses). In practice the efficiency is approximately 80%. *Source:* Sigurd Grimestad

Motors

- AC motors operate very well at 5% over-voltage, but are likely to give trouble at 5% under-voltage. *Source:* George Spencer
 - At 10% under-voltage, the life of fractional horsepower motors will be reduced to three years and the life of 3-phase motors reduced to five years. *Source:* Klaus Kruning
 - For an AC motor, torque varies with the square of the voltage – a 10% loss in voltage is a 21% loss in torque (this is an important consideration for the head of a pump and the rope pull of a mine hoist). *Source:* Jarvis Weir
 - A typical AC induction motor for regular mine service is supplied with a 300% breakdown torque. It operates at nearly constant speed within its normal working range, develops rated horsepower at approximately 97% of no-load speed, and a maximum torque of approximately three times full-load torque at about 80% of no-load speed. *Source:* Domec Lteé.
 - A typical AC induction hoist motor is supplied with a 250% breakdown torque. In application, this means that the peak horsepower of a hoist motor should not exceed 1.8 times the RMS power. *Source:* Larry Gill
-

Motors (continued)

- The difference between a service factor of 1.0 and 1.15 on the nameplate of a motor is a 10⁰C higher allowable temperature rise for the latter. *Source:* W. MacDonald, M. J. Sheriff and D. H. Smith
- For a DC hoist motor, the peak power should not exceed 2.1 times the RMS power for good commutation. *Source:* Tom Harvey
- For a DC hoist motor, the peak power should not exceed 2.0 times the rated motor power for good commutation. *Source:* Sigurd Grimestad
- An AC cyclo-converter hoist motor can have a peak/RMS rating as high as 3. *Source:* E A Lewis
- To permit overhung motors, the air gap for large direct drive DC hoist motors is typically 6mm (0.25 inch). Comparable cyclo-converter drives can have similar or larger gaps. *Source:* E. A. Lewis
- In operation, a typical 575-V AC motor will draw one amp per horsepower. A similar 440-V motor will draw 1¼ Amps per horsepower. *Source:* Bill Forest
- The shaft-mounted cooling fans are bi-directional on AC motors up to 50 HP. Larger motors may be directional and, therefore, rotation should be specified. "Normal rotation" is clockwise facing the non-drive end. *Source:* H. A. Simons Ltd.
- The brushes on an AC machine should be first set at a pressure between two and three pounds per square inch (15-20 kPa). *Source:* General Electric
- The brushes on a DC machine should be maintained at a pressure between three and five pounds per square inch (20-35 kPa). *Source:* General Electric
- The peak inverse voltage from a DC mine hoist motor will be approximately twice the supply voltage so the thyristor bank is designed accordingly. *Source:* Jim Bernas
- The rate of brush wear on DC motors and generators can be kept to an acceptable level if the air has a water vapour density above 5 mg/l. The sensitivity to atmosphere humidity increases at least proportionately to the speed (of rotation of the armature). *Source:* Gerald Tiley

Belt Drives

- The lower side of the belt loop should be the driving side. Vertical belt drives should be avoided. *Source:* General Electric
- 2½ times the diameter of the larger pulley will normally provide a safe working distance between centers. *Source:* General Electric

Transformers

- For a typical mine circuit with multiple components, the capacity required for a transformer, measured in kVA, is approximately equal to the load expressed in horsepower. In other words, a load of 500HP normally requires a transformer with 500-kVA capacity. *Source:* Bill Forest

Primary Power

- For a proposed mining operation it is best to design primary transmission lines for a 5% voltage drop at rated capacity, which should be taken as the maximum 15-minute integrated peak (maximum demand). *Source:* Charles M. Means

23.3 Tricks of the Trade

- During construction of a new mine, all electrical equipment should be assigned an identification number and catalogued with all name plate data recorded. These numbers should be permanently affixed to the equipment and should be done right at the beginning by the receiving department at the warehouse in cooperation with the electrical department. This numbering system should continue through the life of the operation. *Source:* John Kostuik
- It is more efficient to test cables for insulation failures due to manufacturer's defects on the reel at time of delivery before they are transported underground. This does not relieve the installer of testing the cables after installation as well. *Source:* Jim Bernas

- The collector ring surfaces of an electric motor can be kept in better condition by occasionally changing the polarity of the brushes, especially where operating conditions are severe. *Source: General Electric*
- When it is required to dry the windings of an electric motor, it should not be heated above 90°C (thermocouple) or 75°C (thermometer). The heating rate should be controlled such that full heat is obtained after two hours. *Source: General Electric*
- Do not open a switch on a circuit carrying a large amount of current. Trip the circuit breaker first, then open the main switch. Always close the circuit breaker first; then close the switch. *Source: General Electric*
- When checking rotation for connection feeds, the motor should be uncoupled. One second at 1,750 RPM is 30 turns – more than enough to completely destroy a piece of equipment not designed to run backwards. Some operating equipment is very difficult to uncouple. In this case, the leads are properly tagged before disconnecting so that correct rotation is ensured when later reconnected. *Source: Bert Trenfield*
- The capacity of a transformer will be reduced from its rated capacity at 60 cycles per second (Hz) if operated at 50 Hz due to saturation of the magnetic circuit. The capacity of a transformer will be reduced from its rated capacity at 50 Hz if operated at 60 Hz due to increased impedance. You lose both ways. The capacity of the 50-Hz transformer operating at 60 Hz may be restored with forced ventilation (fan cooling), but the 60-Hz transformer operating at 50 Hz cannot. *Source: Jim Bernas*
- When specifying transformers, it is wise to consider liquid filled units with premium insulation, dual rise, and provision for fan cooling. The difference in KVA rating from 55° rise to 65° rise is approximately 12%. Fan cooling can increase the capacity 15% to 20%. The cumulative effect is a built-in allowance for a future increase in load factor of up to 40%. *Source: MacDonald Sheriff and Smith*
- When starting up a generator that has tripped out, it is unnecessary to wait until the machine has come to rest. *Source: General Electric*
- Motor bearing wear can be determined by measuring the air gap between rotor and stator. *Source: General Electric*
- Electricians, not mechanics, should grease and lubricate electrical motors. Over-lubrication is not usually a problem for mechanical equipment, but it is harmful to electrical motors. *Source: Largo Albert*
- At altitudes less than 13,000 feet (4,000m), the textbook reduction factors for the capacity of an electric motor may usually be ignored. *Source: George Greer*
- If the power system can deliver sufficient starting kVa and if the drive can tolerate the loads imposed, across-the-line (direct, on-line full voltage) starting is preferred over other methods. This is because of the simplicity of the starter and the development of maximum starting and accelerating torque for the drive. *Source: MacDonald Sheriff and Smith*
- Motor starters are designed to either IES or NEMA standards. While more expensive, NEMA starters are more robust and have wider range of application. (One NEMA starter is good for motors from 10 HP to 25 HP, while IES has six different sizes in this range.) *Source: Jim Bernas*
- To reduce spare parts inventory, all starters should be of the same manufacturer as many of the parts are interchangeable. This characteristic may extend to across the line and reduced voltage starters as well. *Source: Jim Bernas*
- Diesel generator sets are designed to produce, not receive, electrical power. A mine hoist will generate power into the mains when holding back an overhauling load (regenerating). In this case, a constant load (such as a ventilation fan) at least equal to the hoist motor rating plus 25% of the generator rating should be incorporated into the generator grid. *Source: Jim Bernas*
- One full sized generator (and a small emergency standby generator) better serve a mine development project at a remote location than two generators operating in parallel. The latter invites problems with synchronization. *Source: Bill Forest*
- Second-hand generators are often described by their standby capacity, which may be 20-25% more than their rating for continuous service at the mine. *Source: Jack de la Vergne*
- The capacity of new generators is often described by their continuous rating at unity power factor (PF) (“kVA”), which may be 20-25% more than their rating for typical mine service at 0.8 PF (“kW”). *Source: Jack de la Vergne*
- Aluminum conductors are generally not favored at copper mining facilities even if they are technically appropriate. Copper is strongly preferred as standard for cables and bus conductors. *Source: Julian Fisher*
- Any electrical fault will take the path of least resistance. Without adequate grounding, the path could be someone rather than something. Grounding saves lives. *Source: Julian Fisher*

- During construction of a new mine, it is not uncommon to substitute metal piping and steel tanks with plastic (HDPE, PVC, etc.) that does not conduct electricity. It is important to insure that this substitution does not preclude nor interfere with the planned grounding circuits for the project. There should always be at least some metallic conduits and piping that interconnect equipment and structures built on bedrock or underground. *Source:* Leon Dotson
- Do not allow a fabricator to paint the ends of (or holes in) structural steel members. Bare steel connections are required for proper electrical grounding. For ISO 9000 qualified suppliers, this is not usually a problem; they already know what to do. *Source:* Ross Cudney
- A capacitor (installed for the purpose of PF correction) is subject to high inrush currents of high frequency when another capacitor is nearby, but this is greatly reduced by even small values of inductance between the units. It is advisable not to install capacitors (whether on individual motors or in banks) too close to a bus. This way, there will always be some impedance between any two capacitors that are separately switched. *Source:* Fred Hampshire

23.4 Nomenclature

Table 23-1 shows common electrical abbreviations.

Table 23-1 Electrical Nomenclature

V	EMF (Volts - V)
I	Current (Amperes - A)
R	Resistance (Ohms - Ω)
X	Reactance (Ohms - Ω)
Z	Impedance (Ohms - Ω)
E or P	Power (Watts - W)
f	Frequency (Hertz - Hz)

23.5 Laws and Formulae

$V = IR$ (Ohm's law)

$E = I^2R$ (Joule's Law)

$Z = (X^2 + R^2)^{1/2}$

$\theta = \tan^{-1} X/R$

$E_R = VI\cos\theta$ (Single-phase real power)

$E_X = VI\sin\theta$ (Single-phase reactive power)

$E_R = \sqrt{3}VI\cos\theta$ (Three-phase real power)

23.6 Power Factor

Power factor is used to describe a property of an AC distribution system or piece of equipment. PF is the ratio of actual power used in kilowatts (kW) to the apparent power drawn in kilovolt-amperes (kVA). This is commonly illustrated as shown below.

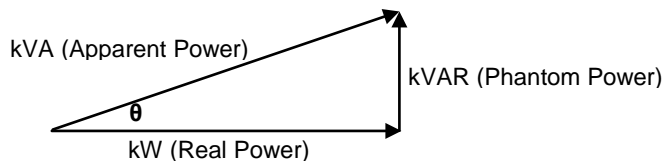

A PF =1.00 is ideal and exists on all resistive loads, such as electric heaters and ovens. Units of electrical equipment containing windings, such as induction motors, transformers, welders, solenoids, belt magnets, lighting ballast, etc. have a PF less than one. The low PF is because a reactive power (kVAR) is needed to provide the magnetizing force necessary for to operate the device. As a result, the voltage is pushed out of phase with the current, causing the current to lag the voltage. The lag is measured in degrees and illustrated by the angle θ in the previous diagram.

Miners in North America tend to underestimate the importance of PF because, unlike Europe, North American utility companies do not normally bill extra for reactive power unless the mine PF is less than a specified value (usually 0.9); however, this practice is gradually being eliminated. In any event, PF correction is an important aspect to consider for any mine distribution system because reactive power has three other adverse effects: (1) heat generation, (2) premature failure of electrical components, and (3) increased voltage drop in power lines and cables.

Two common means exist to improve the PF in a mine's electrical system.

- Provide synchronous motors with a leading PF instead of unity PF
- Install capacitors in switched banks or on individual motors

23.7 Electrical Demand

Electrical experts often use different nomenclature for the same items, but “demand” is a term that is universal. Demand is a fundamental concept in designing power systems and determining electrical consumption.

The definition of demand is best explained by an example. Consider an underground dewatering pump powered by a 100-HP (75 kW) motor (nameplate rating) that pumps water from a sump. The operating characteristic of the system requires only 80 HP (60 kW) from the pump motor. (North American mines tend to oversize electric motors.) The pump operation is intermittent, controlled by level sensors in the sump, such that the pump only operates 45 minutes out of each hour.

- The connected load is 100 HP.
- The “load factor” is 0.8 (80 HP/100 HP).
- The “demand” is the amount of load that can be determined by a demand meter averaged over a specified time interval measured in kilowatts. If the 100 HP pump were fitted with a typical 15-minute demand meter and the pump engaged, the meter would indicate a demand of 30 kW (40 HP) after 7.5 minutes, 45 kW (60 HP) after 11 minutes and 60 kW (80 HP) at 15 minutes and thereafter. (As a result of the delay associated with measuring demand, inrush currents due to motor starting do not affect the demand values since their duration is so short.)
- The “average demand” of the pump is 45 kW (60 HP) (45 minutes/60 minutes x 60 kW).
- The “maximum demand” is a term that does not apply to the pump motor itself, but rather the total electrical system that includes the pump motor. It is defined and explained in the subsequent section.

The capacity (size) of the cable that feeds the pump motor is described in Amps and considers the nameplate HP without consideration of the load factor. If the line voltage to the three-phase pump motor is 440 v, its PF is 0.8 and the motor efficiency is 96%, then the required cable amperage rating is $(100 \text{ HP} \times 0.746 \times 1,000)/(440 \times 0.8 \times 0.96 \times \sqrt{3}) = 127 \text{ Amps}$. When the pump is starting up, the amperage draw is greatly increased, but this is not normally taken into account since the duration of starting is not long enough to overheat the feed cable. If the motor circuit is correctly fitted with a capacitor, the PF becomes unity and in this case the required feed cable capacity rating would be reduced from 127 Amps to 102 Amps.

In an electrical distribution system, the connected load consists of all motors, heaters, transformers, etc. that are installed in the system. If all the loads were operating at 100% nameplate rating, simultaneously for the meter sample time interval, the demand would equal connected load. As indicated above, not all of the connected loads are operating at their maximum or nameplate values. Similarly, not all of the loads are operating at the same time.

From a billing point of view, the “maximum demand” is the highest value of demand as measured by the demand meter over the billing period (typically one-month). The “demand factor” is the ratio of maximum demand to the total connected load.

The “maximum demand” is the amount of power (in kW) that must be made available by the utility (or generating system) to the mine. If PF is less than unity, the utility must supply additional power to compensate for the inefficient use of power on the site. The amount of power that must be provided is equal to the real power used (kW) divided by the PF (less than unity) and expressed as kVA. Various billing structures exist, but generally if the PF is poor, the utility uses the kVA value in its power calculations instead of the kW resulting in a penalty being applied to the customer. When estimating demand (and consumption) for a proposed mining facility, it is customary to omit consideration of this penalty on the assumption that appropriate PF correction will be incorporated into the design of the mine's electrical circuitry.

When estimating demands for a new mine, it is generally assumed that the power required by individual loads will be the nameplate data times the load factor. The summation of all the loads will provide a value of demand that assumes that these loads are all running simultaneously. To obtain “maximum demand,” electrical engineers simply apply a “diversification factor” (based on their experience from similar mines) to the total to reflect the fact that all the loads do not operate simultaneously or always at the assumed load factor.

$$\text{Maximum Demand (kW)} = \Sigma[\text{connected load} \times \text{load factor}] \times \text{diversification factor}$$

The maximum demand in conjunction with the PF is used to estimate power transmission line capacities, transformer capacities, and on-site generator requirements.

23.8 Power Consumption and Cost Estimate

In estimating the amount of power that will be consumed by a motor or other energy consumer, the following formulae are used.

- Motor kW = Motor HP x 0.746
- Load factor (Lf) = Running Load/ Nameplate Rating
- Utilization Factor (U) = Per unit running time/ Per unit time
- Unit Energy Consumption (kWh)= kW x Lf x U x operating hours

Operating hours may be in intervals of a day, week, or month. Typically, utilities calculate consumption over a period of a month. This value should be close to the value obtained by multiplying average demand by interval hours.

Table 23-2 is a spreadsheet example for a proposed 2,500-tpd underground mine applying these explanations.

Table 23-2 Tabulation of Estimated Power Consumption and Cost for a 2,500 tpd Mine
(Operations are 24 Hours per Day, Seven Days per Week)

	Load Description	No. Units	Unit HP	Connected HP	Load Factor	Load (kW)	Utilization Factor	Energy/month (kW hours)
Surface Plant – Main Shaft Area								
1	Skip hoist	1	3,500	3,500	68%	1,775	75%	958,374
2	Cage hoist	1	2,000	2,000	40%	597	90%	386,571
3	Auxiliary hoist	1	500	500	40%	149	100%	107,381
4	Air compressors	3	750	2,250	67%	1,124	90%	728,445
5	Shop equipment	1	60	60	70%	31	20%	4,510
6	Hot water heaters	1	300	300	100%	224	65%	104,696
7	Batch plant	1	75	75	80%	45	30%	9,664
8	Surface pumps	1	80	80	60%	36	50%	12,886
9	Vent fans	1	200	200	95%	142	100%	102,012
10	Lighting	1	30	30	90%	20	60%	8,698
11	Heat trace	1	70	70	100%	52	40%	15,033
12	Parking lot (plug ins)	1	120	120	80%	72	40%	20,617
13	Office, etc.	1	30	30	40%	9	40%	2,577
Surface Plant -Vent Shaft Area								
14	Main Ventilation Fans	4	900	3,600	95%	2,550	100%	1,836,212
15	Pumps	1	25	25	75%	14	67%	6,745
16	Lighting	1	10	10	90%	7	50%	2,416
17	Heat Trace	1	30	30	100%	22	40%	6,443
Underground								
18	Main dewatering pumps	4	250	1,000	80%	597	80%	343,619
19	Sump and mud pumps	1	80	80	80%	48	50%	17,181
20	Underground shops	1	60	60	50%	22	40%	6,443
21	Long hole diamond drill	3	125	375	80%	224	60%	96,643

Table 23-2 Tabulation of Estimated Power Consumption and Cost for a 2,500 tpd Mine (continued)

	Load Description	No. Units	Unit HP	Connected HP	Load Factor	Load (kW)	Utilization Factor	Energy/month (kW hours)
	Underground (continued)							
22	Definition diamond drill	2	75	150	90%	101	70%	50,737
23	DD Recirculation pumps	5	10	50	80%	30	80%	17,181
24	Crusher	1	150	150	75%	84	50%	30,201
25	Crusher auxiliaries	lot	95	95	70%	50	50%	17,852
26	Conveyor Drive	1	125	125	80%	75	60%	32,214
27	Conveyor auxiliaries	lot	30	30	85%	19	60%	8,215
28	Ho-ram (rockbreaker)	2	75	150	80%	89	60%	38,657
29	Stope fans	6	30	180	70%	94	100%	67,650
30	Development duct fan	2	40	80	90%	54	100%	38,657
31	Electric-hydraulic drill jumbo	3	150	450	80%	268	60%	115,971
32	MacLean roof bolter	2	100	200	80%	119	70%	60,133
33	Booster compressor	1	40	40	80%	24	100%	17,181
34	Portable welder	1	34	34	80%	20	10%	1,460
35	Lunch room	1	20	20	80%	12	20%	1,718
36	Underground lighting	1	60	60	90%	40	100%	28,993
	Subtotals		16,209			8,837		5,303,985
	Contingency		10%			10%		10%
	Total Connected Horsepower		17,830					
	Total load (kW)					9,721		
	Diversification factor					70%		
	Maximum Demand (kW)					6,805		
	Energy consumption - month	(kWh)						5,834,383
	Energy consumption - day	(kWh)						194,479

Utility Rates

Energy cost per kilowatt-hour: \$0.046 on peak, \$0.034 off peak

Demand cost per kilowatt: \$8.86 (of maximum demand measured in monthly billing period)

Peak time energy cost per day = 14/24 x 194,479 kWh x \$0.046 = \$5,219

Off peak energy cost per day = 10/24 x 194,479 kWh x \$0.034 = \$2,755

Demand cost per day = 6,805 kW x \$8.86/30 days = \$2,009

Total power cost per day = \$9,983

Cost per ton mined = \$9,983/2,500 tpd = \$3.99/ton

Typical Power Consumption for a Mill (Concentrator)

Table 23-3 shows typical power consumption for a mill.

Table 23-3 Kilowatt-hour per Tonne Processed (Typical Values)

Ore Type		Comminution		Process	Water and Tailings	Service	TOTAL kwh/t
		Crushing	Grinding				
Copper	Open Pit	14		3	2	1	20
Ni/Cu	U/G	16		7	3	2	28
Pb/Zn	U/G	17		12	2	2	33
Cu/Pb/Zn	U/G	19		12	2	2	35
Gold	U/G	5	18	11	5	3	42

Power Consumption for a Mine Hoist

The mine hoist is a major consumer of electrical power; therefore, particular attention is paid to estimating mine hoist power consumption. A common misconception is that the consumption is directly related to the RMS power routinely calculated to determine the power requirements of a hoist drive. Energy consumption is a function of the average energy expended and not the RMS of heating values.

Example

Determine the energy consumption in kWh/ton for the following skip hoist.

Facts:

1. The hoist line speed is 3,000 fpm (15.24m/s)
2. The hoisting distance is 6,000 feet (1,829m)
3. The friction loss in the shaft and headgear is 6% of external work
4. The aerodynamic drag loss is 1% of external work
5. The hoist is direct driven (no gear reduction)
6. The drive is an AC motor equipped with a cyclo-converter
7. The copper losses in the motor, converter and transformers are 18%

Solution: Consider 1 short ton of ore:

1. External work = $2,000 \times 6000/60 \times 60 \times 550 = 6.06 \text{ HPh/ton} \times 0.7457 = 4.52 \text{ kWh/ton}$
2. Loss due to friction and drag = $4.52 \times 0.07 = 0.32 \text{ kWh/ton}$
3. Losses in drive train (none because of direct drive) = 0.00 kWh/ton
4. Copper losses = $4.52 \times 0.18 = 0.81 \text{ kWh/ton}$
5. Reactive power losses (none) = 0.00 kWh/ton
6. Loss for test runs, shaft inspection, brake tests = $4.52 \times 0.02 = 0.09 \text{ kWh/ton}$

Power consumption per short ton hoisted = 5.74 kWh/ton

Check Solution: (Use metrics and rule of thumb)

External work = $1000 \times 9.81 \times 1.829/3600 = 4.98 \text{ kWh/tonne} = 4.52 \text{ kWh/ton}$

System losses are 25% (80% efficiency assumed¹) = $4.52 \times 0.25 = 1.13 \text{ kWh/ton}$

Loss for test runs, shaft inspection, brake tests = $4.52 \times 0.02 = 0.09 \text{ kWh/ton}$

Power consumption per short ton hoisted = 5.74 kWh/ton

¹ Estimate of efficiency determined by judgment (may range between 70% and 85%)

The utility billing normally includes a demand charge in addition to the basic energy tariff. A common misconception is that the demand of the mine's power system is affected significantly by the peak power spike in the hoist cycle. This is not true because a demand meter works by averaging the demand over a much longer period of time (15, 20, or 30 minutes). Even the new generation demand meters (that average over a shorter time interval) are not affected.

23.9 Standard Electrical Motor Sizes

Table 23-4 shows standard electric motor sizes.

Table 23-4 Standard Electric Motor Sizes

0.25 HP	20 HP	225 HP	1,000 HP
0.33 HP	25 HP	250 HP	1,250 HP
0.50 HP	30 HP	300 HP	1,500 HP
1.00 HP	40 HP	350 HP	1,750 HP
1.50 HP	50 HP	400 HP	2,000 HP
2.00 HP	60 HP	450 HP	2,250 HP
3.00 HP	75 HP	500 HP	3,000 HP
5.00 HP	100 HP	600 HP	3,500 HP
7.50 HP	125 HP	700 HP	4,000 HP
10.00 HP	150 HP	800 HP	4,500 HP
15.00 HP	200 HP	900 HP	5,000 HP

23.10 Full Load Current for AC and DC Motors

Table 23-5 shows the full load current (amperes) for three-phase AC and DC motors with normal torque characteristics, running at full load.

Table 23-5 Full Load Current Data

Standard HP	Induction Motors				Synchronous Motors ¹				DC Motors		
	220V	440V	550V	4160V	220V	440V	550V	4160V	120V	240V	500V
5.0	16	8	6						40	20	10
7.5	22	11	9						58	29	14
10.0	28	14	11						76	38	18
15.0	42	21	17						110	55	26
20.0	54	27	22							72	35
25.0	68	34	27		53	26	21			89	43
30.0		40	32		63	32	26			106	51
40.0		52	41			41	33			140	68
50.0		65	52			52	42			174	84
60.0		77	62			61	49			209	101
75.0		96	77			78	62				124
100.0		124	99	14		101	81				165
125.0		156	125	17		126	101	14			205
150.0		180	144	20		151	121	17			243

Table 23-5 Full Load Current Data (continued)

Standard HP	Induction Motors				Synchronous Motors ¹				DC Motors		
	220V	440V	550V	4160V	220V	440V	550V	4160V	120V	240V	500V
200.0		240	192	27		201	161	22			324
250.0		300	240	33		251	201	28			405
300.0		360	288	40		302	242	33			486
400.0		480	384	53		402	322	45			648
500.0		600	480	66		503	403	56			810

¹ For unity PF (for 90% and 80%), multiply Amps by 1.1 and 1.25, respectively.

23.11 Transmission Line Data

Table 23-6 shows transmission line data.

Table 23-6 Transmission Line Data

Voltage (kV)	Capacity (MW)	Phase Spacing		No. of Insulators	Insulator String	
		(feet)	(m)		feet	mm
5	3-10	6	1.8	1	-	-
23	15-45	6	1.8	2	1.0	305
69	40-120	8	2.5	5	2.5	762
115	80-200	16	5.0	8	4.0	1,220
230	240-420	25	7.6	20	10.0	3,050

23.12 Grounding and Bonding

Proper grounding serves several functions on the minesite, including the following.

- Protection of equipment, devices, and circuits from damage caused by lightning.
- Protection of personnel that contact electrically operated devices or equipment.
- Prevention against fire initiated by stray currents.
- Rapid circuit breaking upon ground fault detection.

Non current carrying metal parts of equipment and enclosures are connected to ground by means of a wire connected to the system ground in order to provide a low resistance path to ground that will conduct fault currents rather than through an individual that may simultaneously be in contact with the enclosure.

System grounds refer to an engineered system consisting of a series of ground rods interconnected with buried cables of sufficient size to disperse the fault currents safely. The ground bed is connected to the neutral of a three-phase transformer usually through a resistor to limit the ground currents. This is not to be confused with the fourth wire of a three-phase system, known as the neutral, which is also connected to the neutral of the transformer. The safety of this grounding system is enhanced when it is interconnected with (and bonded to) natural capacitance sinks, such as rail lines, structural steel, metal piping networks, steel tanks, etc. The actual design and installation of the grounding system is complex and strictly regulated by electrical codes. The miner's duty is to understand the importance of grounding, avoid disconnection or damage to grounding conductors and bonds on and between metal structures, and to follow the proper procedures when operating electrical equipment.

23.13 Ratings of Motor Circuit Fuses and Breakers

Table 23-7 shows ratings of motor circuit fuses and breakers as a percentage of full load current based on the Canadian Electrical Code. Table 23-8 shows the same data based on the American National Electrical Code.

Table 23-7 Fuse and Breaker Ratings (CAN)

Motor Type	Starter	Amps	Fuse		Breaker	
			No Delay	Time Delay	Instant Trip	Inverse Time
AC Single ϕ			300%	175%	1,300% ¹	250%
Wound Rotor			150%	150%	1,300% ¹	150%
Squirrel Cage	(1)		300%	175%	1,300% ¹	250%
Squirrel Cage	(2)	to 30	250%	175%	1,300% ¹	200%
Squirrel Cage	(2)	30+	200%	175%	1,300% ¹	200%
Synchronous	(1)		300%	175%	1,300% ¹	250%
Synchronous	(2)	to 30	250%	175%	1,300% ¹	200%
Synchronous	(2)	30+	200%	175%	1,300% ¹	200%
DC to 50 HP			150%	150%	250%	150%
DC 50 HP +			150%	150%	200%	150%

(1) Resistor or reactor starting.

(2) Autotransformer or star-delta starting.

¹ Or at not more than 250% of the motor locked rotor current, when given, except that the ratings need not be less than 15 A.

Table 23-8 Fuse and Breaker Ratings (USA)

Motor Type	Starter	Amps	Fuse		Breaker	
			No Delay	Time Delay	Instant Trip	Inverse Time
AC Single ϕ			300%	175%	700%	250%
Wound Rotor			150%	150%	700%	150%
Squirrel Cage ¹	Regular ²		300%	175%	700%	250%
Squirrel Cage ¹	Autotrans	to 30	250%	175%	700%	200%
Squirrel Cage ¹	Autotrans	30+	200%	175%	700%	200%
Synchronous ¹	Regular ²		300%	175%	700%	250%
Synchronous ¹	Autotrans	to 30	250%	175%	700%	200%
Synchronous ¹	Autotrans	30+	200%	175%	700%	200%
DC to 50 HP			150%	150%	250%	150%
DC 50 HP +			150%	150%	175%	150%

¹ For motor code letters A through E, some ratings may be slightly reduced (see code)

² Full voltage, reactor, or resistance starting

23.14 Fuse Ratings Required for Motor Applications

Table 23-9 shows the required fuse ratings for motor applications.

Table 23-9 Required Fuse Ratings

Across-the-Line Full Voltage Start Normal Industrial Duty		Fuse Amps	Across-the-Line Full Voltage Start Hard Rock Mine Duty		Fuse Amps	Reduced Voltage Assisted Start Mine Or Industrial		Fuse Amps
Motor Full-Load Current - Amps			Motor Full-Load Current - Amps			Motor Full-Load Current - Amps		
From	To		From	To		From	To	
4.0	6.0	15	3.3	5.2	15	6.5	10.0	15
6.1	9.0	20	5.3	7.5	20	10.1	14.2	20
9.1	11.0	25	7.6	9.9	25	14.3	17.9	25
11.1	17.0	30	10.0	15.0	30	18.0	26.0	30
17.1	20.5	40	15.1	18.0	40	26.1	32.0	40
20.6	26.5	50	18.1	22.0	50	32.1	44.0	50
26.6	33.0	60	22.1	28.0	60	44.1	51.0	60
33.1	55.0	80	28.1	47.0	80	51.1	75.0	80
55.1	60.0	100	47.1	51.0	100	75.1	94.0	100
60.1	81.5	125	51.1	71.0	125	94.1	121.0	125
81.6	103.0	150	71.1	94.0	150	121.1	148.0	150
103.1	141.5	200	94.1	125.0	200	148.1	184.0	200
141.5	183.0	250	125.1	164.0	250	184.1	225.0	250
183.1	216.0	300	164.1	186.0	300	225.1	250.0	300
216.1	296.0	350	186.1	257.0	350	250.1	325.0	350
296.1	355.0	400	257.1	307.0	400	325.1	350.0	400
355.1	410.0	450	307.1	357.0	450	350.1	425.0	450
410.1	450.0	500	357.1	407.0	500	425.1	450.0	500
450.1	550.0	600	407.1	515.0	600	450.1	550.0	600

23.15 Worldwide Power Grid Supply System Frequencies

Table 23-10 shows the worldwide power grid supply system frequencies.

Table 23-10 Worldwide Power Grid Supply System Frequencies

(All frequencies shown in Hz)

ARCTIC REGIONS					
Alaska	60	Greenland	50	Nunavut, Canada	60
Lapland	50	Iceland	50	Siberia	50
Faroes	50	NWT, Canada	60	Yukon	60
NORTH AMERICA					
Bermuda	60	St. Pierre & Miq.	50	USA	60
Canada	60				
CENTRAL AMERICA					
Belize	60	Guatemala	60	Nicaragua	60
Costa Rica	60	Honduras	60	Panama	60
El Salvador	60	Mexico	60		
CARIBBEAN					
Bahamas	60	Haiti	50/60	Puerto Rico	60
Barbados	50	Jamaica	50	Trinidad/Tobago	60
Dominican Rep.	60	Cuba	60		
SOUTH AMERICA					
Argentina	50	Colombia	50/60	Peru	60
Bolivia	50/60	Ecuador	60	Surinam	60
Brazil	60	Guyana	50/60	Uruguay	50
Chile	50	Paraguay	50	Venezuela	60
WESTERN EUROPE					
Austria	50	Germany	50	Northern Ireland	50
Belgium	50	Great Britain	50	Norway	50
Denmark	50	Holland	50	Portugal	50
Finland	50	Ireland	50	Spain	50
France	50	Italy	50	Sweden	50
Greece	50	Luxembourg	50	Switzerland	50
EASTERN EUROPE					
Albania	50	Latvia	50	Turkmenistan	50
Czech Republic	50	Lithuania	50	Ukraine	50
Estonia	50	Poland	50	Uzbekistan	50
Georgia	50	Slovakia	50	Yugoslavia	50
Kazakhstan	50	Tajikstan	50		
AFRICA					
Egypt	50	Ethiopia	50	Algeria	50
Angola	50	Benin	50	Ivory Coast	50
Gabon	50	Ghana	50	Guinea	50
Kenya	50	Cameroon	50	Congo	50
Liberia	60	Libya	50	Madagascar	50
Malawi	50	Mali	50	Morocco	50
Mauritius	50	Mozambique	50	Namibia	50
Niger	50	Nigeria	50	Rwanda	50
Zambia	50	Senegal	50	Sierra Leone	50
Somalia	50	Sudan	50	South Africa	50
Swaziland	50	Tanzania	50	Togo	50
Tunisia	50	Uganda	50	Zaire	50

Table 23-10 Worldwide Power Grid Supply System Frequencies (continued)

MIDDLE EAST					
Afghanistan	50	Bahrain	50	Cyprus	50
Egypt	50	Iraq	50	Iran	50
Jordan	50	Kuwait	50	Lebanon	50
Oman	50	Qatar	50	Saudi Arabia	50/60
Syria	50	Turkey	50	Yemen	50
FAR EAST					
Burma	50	China	50	Hong Kong	50
India	50	Indonesia	50	Japan	50/60
Cambodia	50	South Korea	60	North Korea	60
Nepal	50	Malaysia	50	Pakistan	50
Philippines	60	Singapore	50	Sri Lanka	50
Taiwan	60	Thailand	50	Vietnam	50
AUSTRALASIA					
Australia	50	New Zealand	50		

23.16 Worldwide Power Grid Supply System Voltages

Table 23-11 shows common worldwide power grid supply system voltages.

Table 23-11 Worldwide Power Supply System Voltages

Voltages	Location	Voltages	Location
120	North America	6000	Former Soviet Union
220	Europe, South America	6600	Europe
240	United Kingdom	7200	Europe
380	Europe, South America	11000	Europe
460	USA	12500	USA
525	Republic of South Africa	13800	North America
575	Canada	22000	Europe
1000	Coal Mines North America	33000	Europe
2300	USA	34500	USA
4160	North America	44000	North America

24.0 Passes, Bins, and Chutes

24.1 Introduction

Mines take advantage of gravity to collect broken ore by means of ore passes. The ore passes are raises driven by drill and blast or raisebored. While ore passes are most commonly used for underground mining, they are occasionally employed at open pit operations where they are often referred to as “glory holes.” Long raises are also employed as waste passes to drop quarried rock for cemented rock fill (CRF) from surface directly to the mining horizons.

Ore passes often lead to an underground storage bin to provide surge capacity in the ore stream. In turn, the ore is normally drawn off the bottom of the bin into a chute.

The design of passes, chutes, and bins was once a simple exercise and the operations were relatively trouble-free. Today, many hard rock mines experience acute problems – following are the reasons most likely to cause the problems.

- The trend from selective to bulk mining methods.
- The trend toward mining sequences that displace ground stress.
- The trend toward greater level intervals.

Bulk mining is accomplished with larger blastholes on a wider spacing. The result is that the shot rock contains more and larger lumps as well as more fines due to the pulverizing effect in the vicinity of the large explosive charge. The lumps increase impact and the fines worsen the flow characteristics of the broken ore.

Increased level intervals lengthen the ore pass legs and make clearing a hang-up between levels more difficult.

Today, stoping is often completed in a sequence designed to shunt ground stresses away from the mining fronts to the “far field stress regime,” which, unfortunately, may include the country rock surrounding ore passes and underground bins. This phenomenon is usually only significant when mining at great depth.

Another problem relates to specialization and jurisdiction. The successful design and operation of passes and bins is dependent on two separate sciences. The integrity of the walls and protection pillars is a function of rock mechanics while specialists in materials handling are educated and trained to deal with the flow characteristics of the shot rock. Most mines do not retain materials handling technicians on the payroll; therefore, both responsibilities come under the jurisdiction of the rock mechanics department, which may not be qualified or inclined to properly deal with flow of materials.

24.2 Rules of Thumb

Ore Passes

- The flow regime in an ore or waste pass is determined on the basis of the largest particle size of muck (not some average size). This is the fundamental reason for a grizzly at the dump. For example, if a raisebored pass has a diameter of 2m, particles with a diameter of 0.5m will flow freely (4:1 ratio), particles greater than 1m will not flow (2:1 ratio), and sizes in between will produce intermittent hang ups. *Source:* Dr. J. D. Just
 - A circular ore pass raise must be 25% larger in area (section) than a rectangular raise to have similar resistance to hangups due to arching. *Source:* Kirk Rodgers
 - A hangup due to arching is avoided when the ore pass dimension is five times the diameter of the largest particle. *Source:* Beus, Iversen and Stewart
 - Shot rock containing more than 10% fines passing a 200-mesh screen cannot be sent down an ore pass without incurring blockage from cohesive arching. *Source:* Rudolf Kvapil
 - Ore passes should be spaced at intervals not exceeding 500 feet (and waste passes not more than 750 feet) along the draw point drift, with LHD extraction. *Source:* Jack de la Vergne
 - The best inclination for an ore pass in a hard rock mine is 70 degrees from the horizontal. *Source:* Bob Steele
 - The minimum inclination for a short ore pass is 50 degrees from the horizontal. For a long pass, it is 55 degrees. *Source:* Harry Pyke
 - Ore passes cannot be employed to any advantage where the ore dips shallower than 55 degrees from the horizontal. *Source:* Doug Morrison
-

Ore Passes (continued)

- The thrust per cutter on a raisebore head must exceed the compressive strength of the rock by 5,000 psi to achieve a satisfactory advance rate. *Source:* Jim Seeley
- When a hang-up is blasted down in an ore pass, the stress induced on the gate from concussion (detonation wave) is only about ¼ the stress introduced by the impact of falling rock. *Source:* Blight and Haak
- The size of a glory hole in an open pit should not be greater than the cross-section of the haul trucks that dump into it. Otherwise, you are bound to lose a truck, sooner or later. *Source:* Sergio Chavez

Bins

- An underground bin larger than 15 feet in diameter should be inclined at the bottom, away from the outlet, at an angle of 65 degrees from the horizontal, to obtain mass flow (as opposed to rat-holing) where wet fines are present. *Source:* Doug Hambley
- To determine the live load capacity of a bin in a hard rock mine, the angle of repose may be assumed at 35 degrees from the horizontal (top of bin) and the angle of drawdown assumed at 60 degrees. *Source:* Al Fernie

Chutes

- For all but sticky ores, the ideal inclination of a chute bottom is 38 degrees from the horizontal. *Source:* Bob Steele
-

24.3 Tricks of the Trade

- Ore passes should be designed to intersect at a level or sub-level to provide access to clear a hang-up and to repair damage from sloughing. *Source:* Jim Ashcroft
- A steep ore pass should be pulled almost empty when the mine is to be shutdown over a long weekend or holiday. *Source:* Sergei Moskalenko
- Unless efforts are directed at its avoidance, decant water from hydraulic fill containing non-hydrated particles of binder may find its way into an ore pass and cause a hang-up due to cementation. *Source:* Keith Vaananen
- A steep ore pass must never be pulled empty, otherwise the next dump of muck will “air mail” down the pass and can wipe out the chute. *Source:* Bob Brown
- An ore pass with a dogleg is better than one without in terms of impact reduction on the gate at base of the ore pass. *Source:* Blight and Haak
- A raisebored ore pass is more susceptible to hang ups than one of the same diameter that has been drilled and blasted. *Source:* Ken Lowe
- A raisebored ore pass is more susceptible to hang ups than a rectangular raise of similar size. It is easier for material to bridge across a circular shape than a square one. *Source:* Archibald and Friesen
- Finger raises are a neat way to feed a long leg of an ore pass. They may be drop-raised from successive levels or from a different location on the same level. Unfortunately, finger raises are fragile with respect to ground stress. Fingers cause problems (mainly brow sloughing) in shallow mines and almost always cause problems at depth. In highly stressed ground, fingers should be avoided. In many cases, a finger may be replaced with an ore transfer station on the level equipped with control chains. *Source:* Jack de la Vergne
- The only practical inclination for a really long glory hole ore pass is vertical. *Source:* Gord Graham
- In general, the wear resistance of a concrete lining increases as the concrete strength is increased. Lowering of the water/cement ratio through improvement of the aggregate grading and employing the lowest practical slump is more effective in improving wear resistance than the same reduction in water/cement ratio resulting from an increase in cement content. The entrained air content of the concrete should not exceed 4%. *Source:* Troxell and Davis
- Normally, the best aggregates (abrasion resistance and toughness) for a concrete or shotcrete lining are igneous rocks called “traprocks” (basalt, Andesite, diabase, diorite, etc.). The second best are massive metamorphosed traprocks (greenstone). Unsatisfactory rocks include granite, schistose greenstone, limestone, marble, sandstone, and slate. *Source:* Krynine and Judd
- Water should never be used in the attempt to clear a hang-up in an ore pass. *Source:* Menno Friesen

- The traditional way to clear a hang-up is to wrap sticks of powder to build a charge (which may be single or double primed) around the tip of a long-hole loading stick. Then, push this charge up the footwall of the raise by coupling as many loading sticks as necessary. After the charge has reached the hang-up, it is detonated remotely. *Source:* Bob Dengler
- The “Sputnik[®]” is an effective means to safely bring down a hang-up in an ore pass. *Source:* Claude Bouchard
- The procedure of last resort to blast down a hang-up in mid-raise is to long-hole drill into the hang-up and spring the hole with explosives. *Source:* Doug Hambley
- The risk of self-heating (sintering that causes hang-ups) by ore from zones rich in sulfides can be overcome by adding waste rock into ore passes with ore that is over 25% sulfide. The mine geologist makes the call. *Source:* BM&S Corp
- Ground support for an underground bin can be provided by over-drilling blastholes from a pilot raise. Bolts are driven into resin or cement cartridges at the toe of the hole with the drill before the remaining open hole is loaded with explosives and fired. *Source:* Bill Shaver
- Mechanical rock bolts are unsatisfactory to support the walls of raises and underground bins for the long term. The barring effect of vibration can create sloughing faster than if there were no bolts at all. Grouted steel rock bolts are often employed but grouted fiberglass bolts or cable bolts are considered best in the long run. *Source:* Menno Friesen
- The sides of chutes should not be steeper than 60 degrees from the horizontal for ore containing no fines because if an arch of lumps develops at a steep angle it becomes solidified and this makes it difficult to knock down. *Source:* Rudolph Kvapil.
- Chutes that feed conveyors should always have parallel sides (not choking) until the material has landed or is just above the feeder. This means that the choking should always take place in a horizontal fashion by means of the feeder skirt. This way, when the material has reached a position above the feeder it will be shaken through this choke point. *Source:* Ed Cayouette
- Cylinders for chain control press frames should be installed upside down to save the machined surface of the piston rod from wear and tear. *Sources:* Peter White and Heinz Schober
- Most crusher/ore pass feed arrangements choke the flow up in the ore pass. It is better to have a high chute that lets the muck expand upwards while being constricted sideways as it exits the ore pass. *Source:* Peter White

24.4 Ore Pass Inclination

Most mine operators prefer that the ore pass be 70 degrees or steeper, but not vertical. Others prefer that the ore passes are all inclined at near 55 degrees. The steep ore passes are run nearly full, while the ore passes at 55 degrees are run empty. Ore will not run on a footwall inclined at less than 50 degrees, which explains the minimum desired inclination.

One reason for the disparity of opinion among operators may lie in the characteristics of hang-ups. Lumpy ores with few fines tend to hang up in an interlocking arch while ore containing a large amount of fines tends to hang up in a cohesive arch. The lumpy arch is most susceptible to a raise inclination exceeding 60 degrees while a cohesive arch is best avoided in a raise that is near vertical. In mines employing bulk-mining methods, fines are significant explaining why most operators prefer a steep ore pass. Probably, seventy degrees is the preferred inclination since it may be the best compromise to avoid both types of hang-up.

24.5 Ore Pass Size

The required cross section of an ore pass is often determined at an operating mine by a standard based upon past experience. For a proposed mining operation, ore pass size may be determined by one or more of the following methods.

- Rule of thumb
- Standards set at other mines with a similar mining environment
- Empirical methods

Rule of Thumb

In this case, rules of thumb (such as diameter equals 3, 4, or 5 times the maximum lump size) are not adequate.

Standards Set at Other Mines

Standards set at other mines are most often used for a proposed mining operation. This is the most practical method provided that the operating environments are comparable.

Empirical Method

An empirical method was developed by Rudolph Kvapil in the former Czechoslovakia in which a set of curves was developed for each principal characteristic of the ore to be handled. These include lump size, percentage of lumps, gradation, percentage of sticky fines, etc. To obtain the size of ore pass required, the resulting value, k is inserted into the following formulae.

$$\text{Square cross-section of side length, } L: \quad L = 4.6 \sqrt{(d^2k)}$$

$$\text{Rectangular cross-section of width, } W: \quad W = 4.6 \sqrt{(d^2k)}$$

$$\text{Circular cross-section of diameter, } D: \quad D = 5.2 \sqrt{(d^2k)}$$

In which, d = the size of the biggest lumps

k is determined from a nomograph. For typical shot rock from hard rock mines, the following values for ' k ' have been obtained from the nomograph.

$$k = 0.6 \text{ when the content of sticky fines} = 0\%$$

$$k = 1.0 \text{ when the content of sticky fines} = 5\%$$

$$k = 1.4 \text{ when the content of sticky fines} = 10\%$$

In a hard rock mine, all very fine material (passing 200 mesh) is sticky due to water sprayed on the muck pile for dust suppression.

Example

Determine the required size of a square ore pass in the following case.

- Facts:
1. The shot rock is sized with a standard 16 x 18 inch grizzly (Texas gate)
 - The content of sticky fines is 2½%

Solution:

$$L = 4.6 \sqrt{(d^2k)} = 4.6 \sqrt{(1.5^2 \times 0.8)} = 8.3 \text{ feet}$$

In this case, a 7-foot by 7-foot raise will be satisfactory when unavoidable overbreak (during raise development) is taken into account.

24.6 Ore Pass Linings

In bad ground, ore passes are often lined with concrete. In many cases, the concrete is faced with a high strength steel liner that also provides the formwork required to pour the concrete. The steel lined ore pass has proven itself worldwide; however, the high cost and time required often make this design impractical.

Different means are available for placing a concrete lining to reduce the cost. One mine in Idaho developed a system for concrete lining that consists of a "sock" filled with crushed rock. The brattice cloth sock is suspended in a vertical ore pass and the annulus between the sock and the rock is filled with ready-mix. When the concrete is set, the sock is slit at the bottom and the crushed rock falls out leaving behind a lined ore pass. A similar method is to employ a long sausage shaped balloon as formwork. After a pour, it is deflated, elevated, and re-inflated for the next lift.

Another type of lining is shotcrete that may be applied remotely with the use of specialized equipment. Shotcrete containing steel fiber may have a tendency to crack and spall in an ore pass, but shotcrete (or sprayed concrete) containing polypropylene fibers does not have this problem. Shotcrete containing an aggregate of abrasion resistant material, such as carborundum, traprock, or chert is also employed. The method has proven effective in South Africa and at some locations in North America; however, the high price of the special aggregate makes it cost-prohibitive for most applications. (This drawback is now being addressed and may soon be overcome.)

It is generally accepted that the resistance to wear of concrete and shotcrete is mainly dependent on the aggregate employed. It has been proposed that the most economical procedure is to select an aggregate material that has a relatively high abrasion resistance and toughness, such as traprock (basalt, Andesite, diabase, diorite, etc.) or massive "greenstone" (metamorphosed traprock).

24.7 Ore Pass Stability

A circular ore pass is more stable than a square or rectangular ore pass. The latter invites arching on the sides and stress concentration at the corners. The most stable ore pass is a circular raisebored hole; however, this type of pass has two disadvantages. The first is the problem of placing ground support in the raise and the second is the fact that a smooth circular raise is more prone to hang-ups than a rectangular raise that has been drilled and blasted. In highly stressed, burst prone ground, an ore pass usually has to be raisebored for safety reasons. The same reasons make placing ground support in the raise problematic.

The stress regime in the walls of the ore pass may be exacerbated by ground stress shunted from the mining. In some cases, the ore pass itself may become a source of seismic activity. One authority proposed that ore passes should not be employed in burst prone ground. He suggests that ramp haulage or “throw away” mill holes may be employed, instead. The mill holes would be left filled with waste rock after failure.

24.8 Damage Control

The immediate problems with ore passes are hang-ups and mud rushes. The major long-term problem is severe damage to the headblock at the base of the raise. The common view is that this damage is caused by (1) blasting down of hang-ups, and (2) allowing the raise to be drawn empty. Test work carried out at the Spokane Research Laboratory indicates that the real culprit is more likely to be large chunks of rock that slough off (or escape the grizzly) and fall down a pass that has been drawn nearly empty.

24.9 The Perfect Ore Pass

In the real world, it is a rare situation that a “perfect” ore pass can be made to fit into an actual mining plan. Nevertheless, the ideal design makes a good benchmark against which a proposed layout may be compared. Based on the considerations described above, the theoretical optimum design for an ore pass in the best of ground has the following design characteristics.

- Located outside the zone of stress induced by mining activity.
- Pilot-hole diamond drilled (that may be used for slim-line grouting if groundwater is encountered).
- Developed using drill and blast techniques (rather than raisebored).
- Length not to exceed 60m (200 feet).
- Square in cross-section (rather than rectangular or circular).
- Size determined by Kvapl formula (example shown in Section 24.5).
- No finger raises (to avoid brow slough).
- Shotcrete applied for temporary ground support (instead of bolts and screen).
- Spot bolting with resin and fiberglass as required for safety (no pattern bolting).
- Grouted cable bolts installed for permanent support.
- Pass is not lined with concrete (very good ground is assumed).
- Top of raise incorporates an elevated and steel-lined concrete collar (high enough to prevent transient mine water from flowing into it).
- Raise inclination normal (not parallel) to natural rock foliation or joint sets.
- Pass inclined at 70 degrees from the horizontal.
- Bottom end dogleg (70-55 degrees) in the vertical plane (never the horizontal).
- Pass inclined at 55 degrees beneath the dogleg.
- Pass inclined at 40 degrees and lined with steel on concrete at exit from the raise.
- Steel lining should be AR plate or billets (not rails).
- Muck flow controlled using chains and press frame (no gate) to avoid hydrostatic pressure build-up.
- Muck flow constricted (choked) at an angle of 30 degrees to the line of flow.
- Constriction to take place at the top end of the chute (instead of inside the raise).
- Headblock located high – well above the line of muck flow.
- Low-level monitor installed to help assure that the pass is not drawn empty.
- Top-level controls installed to measure level of ore in the raise.
- Level of ore in the raise monitored at a central control room.
- Crushed and screened rock to be used to fill the bottom end of the raise at the start of operation.
- Crushed and screened rock to be used to fill the bottom end of the raise after being drawn empty for remedial work.

24.10 Glory Hole Ore Passes

Glory holes in open pits are usually vertical and sized at 5 to 6 times the largest particle size to be passed. This typically results in a diameter between 16 and 20 feet for the glory hole. Some problems are specific to the glory hole raise; one is ore attrition. In some cases where the "ore" is an industrial mineral such as limestone, its value is reduced if much of it comes out the bottom of the pass as dust. The second problem is enlargement of the glory hole due to sloughing. As the pit deepens, millions of tons of material gradually wear the pass to a much larger dimension. This point is emphasized when a huge pit truck falls down the glory hole late in the mine life as occurred first at Cananea, and then at Hinton.

For some mining applications at high altitude, very long vertical ore passes are required. These long passes are normally excavated using a raiseborer. These passes are similar to the long waste rock passes employed for CRF except the ore passes are normally run empty while a waste rock pass is designed to be kept nearly full. The glory hole ore passes have all the problems of regular ore passes, plus some of the following.

- Air blast
- Ricochet
- Coriolus effect
- Attrition
- Raisebore pilot deviation

Air Blast

Because this type of ore pass is normally designed to feed directly into an underground bin, it is run empty. This means that the ore stream obtains very high velocities resulting in intermittent air blasts due to the piston effect that must be relieved by an underground connection to a relief airway. A second ore pass connected to the same bin underground may provide the required relief.

Ricochet

The high velocity of the ore stream produces tremendous impact at the bottom of the raise; therefore, the geometry is designed to provide an impact bed (rock box) at the bottom of the raise. In some cases, liners are required to handle the ricochet (bounce) from the rock box. Another ricochet phenomenon occurs when the glory hole raise is fed with a conveyor. The horizontal motion of ore on the conveyor continues when the ore stream falls into the raise. The result is an impact on the far side of the raise and subsequent ricochet to the near side. If nothing is done to mitigate this action, it produces wear in the upper portion of the raise.

Coriolus Effect

The earth's rotation tends to direct the ore stream towards the East wall (Coriolus effect). A simple calculation reveals that the deviation is normally only a few inches and may be ignored. (The calculation and results can be found in Chapter 10 – Shaft Sinking.)

Attrition

The loss of potential energy due to the drop of the ore stream is divided between friction and comminution of the ore. The total potential energy is simple to calculate. The portion of this energy that results in attrition is difficult to estimate in advance. The amount of attrition is important if the ore is to be treated in an autogenous mill. If the ore has a high work index, and a conservative fraction is assumed for comminution, the amount of reduction in lump size is not normally significant. In some cases, such as a limestone quarry or a rock fill quarry, the generation of fines by attrition may result in an unsatisfactory product.

Raisebore Pilot Deviation

The long pilot hole required to back ream a glory hole is subject to lateral deviation. In some cases, the hole may be drilled using the raiseborer when the deviation trend is known by adjusting the pilot hole alignment (Kentucky windage); however, a directional drilling technique is required for very long holes.

In hard rock, a long glory hole is not normally lined. Instead, two glory holes are provided near the same location for the following three reasons.

- Lining a long glory hole properly is more expensive than drilling the hole.
- A second raise provides the required relief to exhaust the air blast.
- If one raise becomes inoperable, the second raise is available.

24.11 Fill Raises

The same principles that apply to glory holes also apply to long waste rock passes that supply aggregate for CRF. In temperate climates, these raises have problems with frozen material during the winter months since the raises are maintained nearly full. One remedy for this problem is to add calcium chloride to the waste rock. Another problem is ground water in the raise and snow or ice in the fill material that disrupts the water/cement ratio when the aggregate is later cemented. (Refer to Chapter 21 – Backfill.)

24.12 Bins

Underground bins are required to provide surge capacity to the ore stream. In the past, small mines simply slashed out an ore pass between levels to provide a bin. Today, most underground bins stand vertical and have a circular cross section. Larger bins are built with the bottom coned to inhibit rat holing of the ore. In some cases, liners are provided in the cone section to improve ore flow. Until recently, the maximum practical underground bin diameter was approximately 28 feet. The completion of a 75-foot diameter excavation designed to collect neutrinos from outer space at a depth of 7,000 feet in the Creighton Mine may have removed this cap on the maximum size.

Underground bins are usually provided with ground support consisting of fiberglass bolts or cable bolts. Solid steel bolts vibrate when struck by ore particles. This is believed to abet sloughing of the walls.

24.13 Chutes

Chutes are inclined steel troughs used for transferring shot rock. Near vertical chutes are covered on four sides and equipped with an access door. Inclined chutes are often left open on top to facilitate clearing blockages. The chute width should never be less than three times the size of the largest lump to be free running. Chute inclination in most operating mines varies between 37 and 40 degrees. Steeper chutes may be required for sticky muck.

Once the inclination is determined, the angle of the back plate is normally the most important consideration. If the sides of the chute are not vertical, the angle of the intersection of the slopes (valley angle) is a critical consideration because it is always less than the slope of either of the intersecting sides. In hard rock mines, it may be good practice to weld a fillet at the intersection of the plates to increase the valley angle.

Example

Determine the valley angle, C in the following case.

- Facts:
1. The back plate of a chute is inclined at 45 degrees to the horizontal, A = 45 degrees
 2. The chute side plates are inclined at 54 degrees to the horizontal, B = 54 degrees

Solution: $\text{Cot } C = [\text{cot}^2 A + \text{cot}^2 B]^{1/2} = [1 + 0.528]^{1/2} = 1.236$
 Valley angle, C = 39.0 degrees

25.0 Crushers and Rockbreakers

25.1 Introduction

Hard rock mines use rockbreakers and crushers for two fundamental reasons:

- To facilitate the transport of ore from the mine to the mill, and
- To initiate the size reduction process required to concentrate the ore.

Crushers

Only three types of crushers are normally used in the hard rock mining industry.

- Jaw crushers
- Gyratory crushers
- Cone crushers

In the crushing circuit, gyratory and jaw crushers are normally employed as primary crushers, while cone crushers serve as secondary or tertiary crushers. Primary crushers normally operate in open circuit while cone crushers operate in either open or closed circuit. (The coarser portion of the product is separated and re-circulated through the crusher in a closed circuit.) In some primary crusher installations, fine-sized material is scalped from the feed before it enters the crusher and reunites with the crushed product after bypassing the crusher (short circuit).

Product Size

In the past, primary crushers provided a product of 4-6 inches (100-150mm) to feed secondary (cone) crushers. Small modern mines continue with the traditional primary crusher product size that is then directed to secondary and tertiary cone crushers to reduce the particle size enough to permit a single grinding stage.

Medium and large sized mines are typically designed to provide feed directly to an autogenous mill. For this reason, the desired product from the primary crusher has increased to 8-12 inches (200-300mm) to provide a grinding medium (cone crushers are eliminated). However, the cone crusher has found a new role at some larger mines crushing the coarse fraction of the output from an autogenous mill for subsequent re-circulation. This procedure permits the reduction ratio (ratio between size of feed and product) required of a subsequent ball mill to be kept within practical limits.

Before the advent of the modern rockbreaker, over-size material feeding the primary crusher was a greater problem than it is today and primary crushers were designed largely on the basis of gape (minimum dimension of feed opening) rather than capacity. As a result, typical practice underground was to crush the daily requirement in 1 or 1½ shifts and provide sufficient storage in passes and bins to feed the crusher continuously throughout the operating shift(s).

Rockbreakers enable smaller crushers to be employed for the same service, but the old principals of underground primary crusher sizing persist, perhaps to reduce the cost of operating labor and the frequency of maintenance and repairs.

Truck Haulage

Underground mines served by truck haulage from ramp or adit do not require an underground crusher, but there is a limit to the amount of traffic that such an entry can bear. Several current trends are allowing the vertical depth to which ore bodies may be practically exploited by truck haulage to increase.

- Larger trucks (up to 70-tonne capacity)
- Road trains (truck tractor and trailers)
- Twin entries (permitting one-way traffic)
- Block signals (and even transponders) to control traffic

Nevertheless, when high production is to be transported over a long distance, a crusher-fed belt conveyor remains a more economical alternative.

Belt Conveyor

A primary crusher is invariably required before a belt conveyor transports ore, except over a relatively short distance without a turning point (transfer to a second leg of belt conveyor). Operators report that sizing is not the only important function of the crusher that feeds a belt conveyor. The crusher helps to ensure the removal of treacherous tramp metal (such as rock bolts and rebar).

Practice in large open pits has been to provide huge in-the-pit portable crushing plants with belt conveyor haulage to surface and the concentrator. Where the topography is in steep relief, there is still occasional application for glory holes (ore passes of large diameter) within (or near) the pit that typically feeds an underground crusher (Exshaw, Cananea, El Teniente, Carol Lake).

Rockbreakers

Rockbreakers are employed to reduce the size of oversize ore and rock (shot muck). Two categories of oversize muck exist, based on size.

- The larger size consists of shot muck that is too big for handling with an excavator (shovel or LHD unit) at the pit bench or the underground face. Traditionally, the large size muck was broken up by secondary blasting (a few open pits employed a drop hammer). Today, some mines employ a mobile rockbreaker for this purpose. A recent innovation is a portable drill that splits the oversize by hydro-fracture (ultra-high water pressure) after drilling a single hole.
- The smaller size consists of shot muck that is too large to fit in the mouth of a primary crusher or pass through a grizzly (Texas gate). Once “tapped” by hand with a sledgehammer, the muck is now broken with a rockbreaker that normally consists of a percussive breaker unit attached to a pedestal-mounted boom (stationary). The breaker unit is similar to (but much larger than) a common pavement breaker, except that is normally hydraulic rather than pneumatic. This type of rockbreaker operates over a horizontal grizzly, sized to fit the application.

Installation Cost

The installation cost of an underground crusher is considerably higher than one on surface. This is one reason that mine planners investigate options that use rockbreakers alone to eliminate the requirement for an underground crusher.

Small Mines

In the past, the smaller hard rock mines served by shaft entries (that did not employ bulk mining methods) rarely had a primary crusher underground. Today, these small mines typically use only rockbreakers for underground sizing. Some medium sized mines employing Blasthole mining methods are also successful with the use of only rockbreakers.

Large Mines

Some of the largest underground mines in the world do not need underground crushers. In these cases, the required capacity of the ore handling conveyances is so large, there is little problem handling ROM (uncrushed) ore that has been “sized” with rockbreakers. For example, it makes little sense to haul ore in 15-ton capacity rail cars to an underground crusher to facilitate hoisting in 30-ton capacity skips.

Run-of-Mine Ore Hoisting

In the past, a number of open pits hoisted ROM ore with an inclined skipway up the wall of the pit. This technology is apparently obsolete, but the principle of hoisting ROM ore in large skips designed for this purpose has been re-visited. The result is a proposal for medium-sized underground mines to apply this procedure to vertical shaft hoisting with two parts of line (“crusher-saver hoisting”).

25.2 Rules of Thumb

Crusher Selection

- For a hard rock mine application below 600 tonnes/hour, select a jaw as the primary crusher. Over 1,000 tph, select a gyratory crusher. Between these capacities, you have a choice. *Source:* Chris Ottergren
 - For a hard rock mine application below 540 tonnes/hour, a jaw crusher is more economical. Above 725 tonnes/hour, jaw crushers cannot compete with gyratory crushers at normal settings (6 -10 inches). *Source:* Lewis, Cobourn and Bhappu
 - For an underground hard rock mine, a gyratory crusher may be more economical in the case where its required daily production exceeds 8,000 tonnes of ore. *Source:* Jack de la Vergne
 - If the hourly tonnage to be crushed divided by the square of the required gape in inches is less than 0.115, use a jaw crusher, otherwise use a gyratory. (If the required capacity in metric tph is less than 162 times the square of the gape in metres, use a jaw crusher.) *Source:* Arthur Taggart
 - Nearly all crushers produce a product that is 40% finer than one-half the crusher setting. *Source:* Babu and Cook
-

Crusher Selection (continued)

- The product of a jaw crusher will have a size distribution such that the -80% fraction size (d_{80}) is slightly less than the open-side setting of the crusher. For example, if the open-side setting is 6 inches, the d_{80} product size will be 5¾ inches. *Source:* Unknown
- In a hard rock mine, the product from a jaw crusher will tend to be slabby, while the product from a gyratory crusher may tend to be blocky, the latter being easier to convey through transfer points on a conveyor system. *Source:* Heinz Schober
- Impact crushers (rotary or hammer mills) have the capacity for high reduction ratios (up to 40:1), but are rarely applied to hard rock mines. Since they depend on high velocities for crushing, wear is greater than for jaw or gyratory crushers. Hence, they should not be used in hard rock mines that normally have ores containing more than 15% silica (or any ores that are abrasive). *Source:* Barry Wills

Crusher Design

- The approximate capacity of a jaw crusher for hard rock application at a typical setting may be obtained by multiplying the width by 10 to get tonnes per hour. For example, a 48 by 60 crusher will have a capacity in the order of 600 tph when crushing ore in a hard rock mine. *Source:* Jack de la Vergne
- The capacity of a jaw crusher selected for underground service should be sufficient to crush the daily requirement in 12 hours. *Source:* Dejan Polak
- For most applications, 7:1 is the maximum practical reduction factor (ratio) for a jaw crusher, but 6:1 represents better design practice. *Source:* Jack de la Vergne
- A well-designed jaw crusher installation has the lip of the chute overlapping the throat of the vibrating feeder by 400mm (16 inches) to prevent spill resulting from the inevitable blowback of wayward fines. *Source:* Jean Beliveau
- For most applications, 6:1 is the maximum practical reduction factor (ratio) for a cone crusher, but 5:1 represents better design practice. *Source:* Jack de la Vergne
- Corrugated liner plates designed for jaw crushers (to avoid a slabby product) result in shortening liner life by up to two-thirds and they are more prone to plugging than smooth jaws. *Source:* Ron Doyle

Crusher Installation

- The crushed ore surge pocket beneath a gyratory crusher should have a live load capacity equal to 20 minutes of crusher capacity or the capacity of two pit trucks. *Various Sources*
- It will take six months to excavate, install, and commission an underground crusher station for a typical jaw crusher. For a very large jaw crusher or a gyratory crusher, it can take nine months. *Source:* Jim Redpath
- The desired grizzly opening for an underground jaw crusher is equal to 80% of the gape of the crusher. *Source:* Jack de la Vergne
- The maximum feed size for a jaw crusher should be about 85% of the gape. *Source:* Arthur Taggart
- The combination of a jaw crusher and a scalping grizzly will have 15% more capacity than a stand-alone jaw crusher. *Source:* Ron Casson
- As a rule, scalping grizzlies are rarely used anymore for (large) primary crushers. The exception is when ore contains wet fines that can cause acute packing in a gyratory crusher. *Source:* McQuiston and Shoemaker
- The product from a jaw crusher will tend to be less slabby and more even-dimensioned without a scalping grizzly, since slabs do not pass through so readily under this circumstance. *Source:* A. L. Engels
- Removal of the scalping grizzly for a primary jaw crusher can cut the liner life by 50%. It also makes it more difficult to clear a jam when the jaws are filled with fines. *Source:* Ron Doyle

Crusher Costs

- The total cost of a jaw crusher installation underground may exceed six times the cost of the crusher itself (purchased new), while on surface the factor is usually between three and four. *Source:* P. White and H. Lang
 - With a typical 6:1 reduction ratio, the power consumption of a large jaw crusher (48 by 60) is approximately 1.8 tons per horsepower-hour (2.2 t/kWh). *Source:* Arthur Taggart
-

Crusher Costs (continued)

- The power consumption of a 42-inch gyratory crusher is approximately 2.4 tons per horsepower-hour (2.9 t/kWh). *Source: Arthur Taggart*
 - Power consumption of a jaw crusher when idling is about 50% of full load, for a gyratory it is approximately 30%. *Source: Richard Taggart*
-

Rockbreakers

- The capacity of a hydraulic rockbreaker is higher (and the operating cost lower) than a pneumatic rockbreaker. For these reasons, most new installations are hydraulic, despite the higher capital cost. *Source: John Kelly*
 - For underground production rates less than 2,000 tpd, it may be economical to size the ore underground with rockbreakers only, otherwise, an underground crusher is usually necessary when skip hoisting is employed. *Source: John Gilbert*
 - The operating cost for a stand-alone rockbreaker will be approximately 30% higher than it is for a crusher handling the same daily tonnage. *Source: John Gilbert*
 - The capacity of one rockbreaker on a grizzly with the standard opening (± 16 by 18 inches) is in the order of 1,500-2,000 tpd. *Source: John Gilbert*
 - For skips that fit into a standard 6 by 6 shaft compartment, the maximum particle size that is normally desired for skip hoisting is obtained when ROM muck has been passed through a grizzly with a 16-18 inch opening. Skips hoisted in narrow shaft compartments may require a 12-14 inch spacing, while oversize skips may handle muck that has passed a 24-30 inch spacing. *Source: Jack de la Vergne*
 - A pedestal-mounted rockbreaker installed should be equipped with a boom that enables a reach of 20 feet (6m). *Source: Peter van Schaayk*
-

25.3 Tricks of the Trade

- A crushing circuit over-designed for the application will not increase the operating cost and provides for future expansion. A crushing circuit under-designed for the application (particularly with respect to reduction ratios) can increase operating costs dramatically. *Source: Jack de la Vergne*
- Omitting the scalper provides more rock against rock comminution resulting in a better shaped product. *Source: Ekkhart Matthies*
- A new jaw crusher manufactured in China may cost less and be more rugged and reliable than a rebuilt crusher purchased from the North American after market. *Source: Luis Browne*
- Provision of a bolt cutter and screen baler in the crusher room facilitates handling of material picked from the ore stream. *Source: Jim Robinson*
- The foundation design for primary jaw crushers should provide walk-in capability for maintenance on the toggles and lower jaw liners. The incorporation of a cylinder-actuated sliding floor beneath the foundations provides a safe working platform in an underground mine. *Source: Peter White*
- Never dump a large piece of rock into a full jaw crusher; allow jaws to empty first. *Source: John Smith*
- Normally, a jaw crusher will operate best if it is kept just full but not flood fed. If full, it will experience less plate wear because a greater portion of the breakage is autogenous (i.e. attrition between particles of ore). Attrition is increased (and jamming less likely) if the fines are first scalped from the ore. Dribble feeding increases wear on the jaw plates due to bouncing and lack of attrition. *Various Sources*
- A gyratory crusher usually operates best at 80% of rated maximum speed. *Source: Allis Chalmers*
- An easier way than using lead to determine the closed side setting of a cone crusher is to throw in an empty soft drink or similar can and measure its thickness after it has passed through the crusher. *Source: Dave Assinck*
- If the automatic lubricating oil temperature of a crusher exceeds 120 degrees F., there is likely to be a fault or restriction in the oil flow. *Source: Unknown*

- A difference exceeding 2 degrees C. between the inlet and outlet lubricating oil of a crusher is an indication of a problem developing. If it reaches 3 degrees C., the crusher should be shut down and all bearings examined. *Source:* Unknown
- The ducts that collect dust from a crusher installation should incorporate smooth elbows and the air streams at connections should not impinge at an angle greater than 30 degrees. *Source:* Joe Bryan and George Rodger

25.4 Jaw Crushers

Jaw crushers are used as primary crushers in some open pit mining operations and in almost all medium-sized underground hard rock mines. Outside of North America, jaw crushers are occasionally used as a secondary crusher. One of the largest capacity jaw crushers is a custom built 63 by 83 (1,600 by 2,100) unit that operates in an open pit with a stated capacity of 1,200 tph when set at 16 inches (400mm). The largest jaw crushers normally found underground in hard rock mines are 48 by 66 units that can be opened up to a maximum setting of about 10 inches. (Jaw crushers manufactured in China and Eastern Europe may be opened wider than those normally built in North America, Western Europe, or Brazil.)

Capacity

Jaw crusher capacity for a particular application may be obtained by consulting manufacturers' catalogues that contain capacity tables (accurate to $\pm 20\text{-}25\%$) for the different models. For most applications, jaw crushers come in standard-sized models that are similar from one manufacturer to another. Traditionally, these sizes denote the gape and width expressed in inches.

A concern often exists that the ore to be crushed from a hard rock mine is much stronger (higher compressive and impact strength) than the reference material (usually limestone) on which the tables in manufacturers' catalogues are based. The fact is that it makes little difference to the capacity of a crusher. Hard rock ores may tend to reduce volumetric capacity by a small amount but compensation for this is obtained because a broken ore fed to the crusher usually has a higher bulk density than broken limestone. In other words, the capacities indicated in the tables normally require no modification for a hard rock mine application; however, the same is not true of the drive motors listed for the different sized models, as explained below.

Power Consumption and Drive Capacity

The power consumption and drive capacity (HP) required for a proposed jaw (or any other) crusher may be determined with the appropriate application of Bond's law. The procedure is fully explained in Chapter 26 – Mineral Processing. Instead of using the Bond W_i , some crusher manufacturers modified the procedure to obtain a "crusher work index" (CWi) intended to be a more accurate value for the application.

Ores from hard rock mines are often harder than the reference material (with a W_i of maybe 12) that is the basis of manufacturer's tables. Where the work index of the ore to be crushed exceeds 15, there should be a comprehensive investigation into the size of drive motor required. A typical result is to kick the motor size up to the next nearest standard size (i.e. 200 HP to 250HP).

Scalping the Crusher Feed

Traditionally, the feed to a jaw crusher is scalped to remove the fine portion of the feed (that does not require size reduction) just before the ore stream enters the crusher. The separated material drops beneath the crusher where it is reunited with the crusher product. Most new installations omit the scalping operation, and, in fact, scalpers have been removed from some existing operations. This change in crushing philosophy is the subject of continued debate. Some operators endorse the change while others are dead against it. Following is a list of arguments for and against the change to traditional design.

Arguments for retaining the scalper

- The throughput capacity of the installation is increased.
- Crusher jams may be less frequent.
- Liner plate wear rate is reduced.
- If the scalped fines are dropped separately onto a load out belt, they cushion the subsequent landing of coarse material.

Arguments against retaining the scalper

- The product is less slabby.
- The installation is more compact, saving space.
- Access to the liner bolts on the back of the fixed jaw is facilitated.
- A significant saving in capital cost is realized.
- All particles are reduced in size (rather than only the big pieces) thereby assisting the comminution effort at the mill (concentrator).

Jaw Crusher Types

The two distinct types of jaw crusher employed in hard rock mines are single toggle and the double toggle. For primary jaw crushers it has been general practice for underground hard rock mines in North America to employ the double toggle, Blake type. In northern Europe, especially Sweden, the single toggle is typically employed, overhead eccentric type (LKAB, Kiruna). Either single or double toggle crushers are used for most mobile "in-the-pit" crushers, but single-toggle crushers are used exclusively for semi-portable crushers when employed underground.

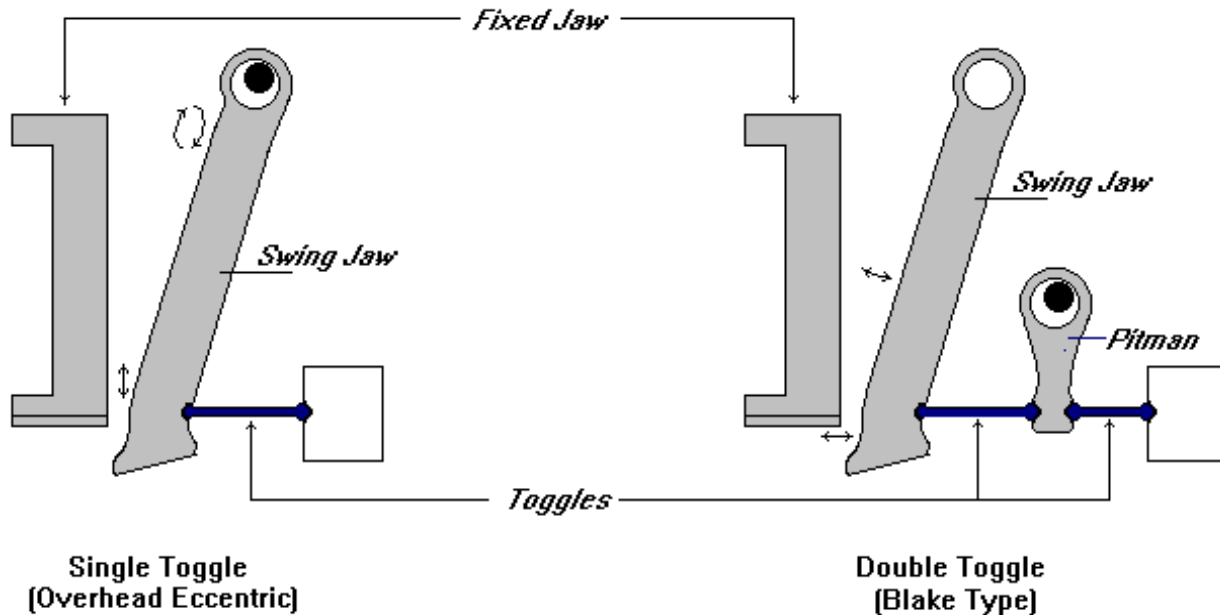

Figure 25-1 Jaw Crusher Types

Single Toggle

The single toggle crushers weigh half to two-thirds as much as double toggle and are usually much less expensive; however, they have higher maintenance and repair costs. Higher costs are logical, based on the operating mechanism. At least a portion of these costs may be alleviated if the foundation or supporting steel is designed more robust than required for a comparable double toggle crusher. No good evidence exists proving that there is any difference in the power consumption between a single toggle and a comparable double toggle crusher.

The single toggle crusher drives the swing (moving) jaw in the following two ways.

- The moving jaw is supported directly by means of a single eccentric drive shaft that causes it to move in an elliptical path at the top end.
- The single toggle diminishes and restricts this motion to near linear at the bottom (discharge) end of the moving jaw.

The toggle is typically designed to shear or break if tramp iron enters the jaws, and other safeties fail to stop the crusher. Some manufacturers refer to the swing jaw of a single toggle crusher as the "pitman," which can be confusing.

The single toggle crusher is credited with the following additional advantages.

- Higher throughput (capacity) than a comparably sized double toggle crusher because the unique action of the swing jaw provides gravity assist to the passage of the material to be crushed.
- Compact size means a smaller excavation is required when the machine is installed underground. Normally, the savings are due to the shorter length of the installation; however, the single toggle inclined jaw crusher (Eagle®) also saves on height.

Double Toggle

The double toggle crusher drives the moving jaw through a separate eccentric drive shaft that moves the front and rear toggles up and down at each revolution of the shaft, by means of a pitman (connecting rod). The moving jaw is supported by and pivots about a separate shaft. The front toggle is connected to the moving jaw at a right angle. A special front toggle (shear toggle) can be supplied as an option designed to break if tramp iron enters the jaws, and other safeties fail to stop the crusher.

The double toggle crusher is credited with the following advantages.

- Lower operating cost due to less frequent liner change-outs (because jaw action does not have a scrubbing action).
- Lower operating cost due to less frequent bearing failure (because a lighter load is suspended from the eccentric).
- Less subject to fatigue failure (crack initiation) in component parts caused by secondary vibration.

25.5 Gyratory Crushers

Gyratory crushers operate on the principal of a mortar and pestle. They depend on a reciprocating eccentric mechanism similar to the single-toggle jaw crusher; however, the main shaft is vertical and driven from beneath through a right angle pinion shaft and gears that permits the drive motor to be mounted horizontally. A tapered "head" on the main shaft rotates with an eccentric motion around a conical bowl crushing the muck. The setting of the gap in the annular space between the head and the liners on the bowl controls the size of the product that falls through. The throw of the eccentricity is usually between 1 and 1½ inches. This throw makes up the difference between the "open-side" and "closed side" setting.

Before the advent of in the pit crushing and conveying, stationary gyratory crushers were the default selection for open pits due to high capacity, flood feed ability, and uniform product dimensions. More recently, custom-built gyratory crushers (sectionalized) have been applied to larger underground mines to enable component transport through a mine entry. The heaviest component of even a custom built gyratory is heavier than that of a jaw crusher of the same minimum dimension (gape) of feed opening. For example, the bottom shell section of one name brand 42-65 gyratory weighs 56,400 Lbs. while the swing jaw of a 42 by 48 jaw crusher may weigh 24,000 Lbs. The feed openings of the two crushers are comparable, but in this case the gyratory has triple the capacity of the jaw crusher.

25.6 Cone Crushers

Cone crushers are a type of gyratory crusher that serve as secondary or tertiary units in a crusher circuit. In simple terms, a cone crusher may be thought of as a small gyratory crusher; however, the standard cone crusher (invented by Edgar Symonds) is different from a gyratory, as shown below.

- No spider exists to interfere with the feed.
- The cone is constructed at a flatter angle.
- No upper bearing exists for the gyratory shaft.
- The head gyrates much faster.
- Springs attached to the frame act as a safety device allowing the crushing bowl to rise if tramp iron is encountered.

Following are different types of cone crushers.

- Short-head Crusher – a stubby version of the standard cone crusher normally used for fine crushing in closed circuit.
- Hydrocone[®] Crusher – a proprietary cone crusher that may be used as a standard or a short head, depending on the crushing chamber design.
- A Gyradisc[®] Crusher – a proprietary cone crusher specifically designed for very fine crushing.
- A Water Flush[®] Crusher – a proprietary cone crusher that employs water as the medium, as opposed to crushing dry.

25.7 Jaw Crusher versus Gyratory Crusher

When designing a large underground mine (or a relatively small open-pit mine), a common question is whether to select a jaw or a gyratory crusher as the primary. The decision can often be made by using rules of thumb, but further investigation is usually desirable. The following observations are useful in a more comprehensive determination.

- The installed cost of a jaw crusher is less than a gyratory in part due to less foundation work. Thus, portable and self-propelled units most often use a jaw crusher.

- For a stationary installation in an underground mine, jaw crushers are the conventional choice for the following reasons.
 - Approximately 50 feet (15m) less vertical distance is required in the crusher room.
 - Liners are more easily and more quickly replaced when worn.
 - Large feed opening (gape) in relation to capacity.
 - Usually better able to handle fines and sticky feed.
 - May be installed to discharge directly onto a belt, eliminating the requirement for a surge pocket or feeder.
 - Good competition exists between suppliers of new units.
 - An ample supply of second-hand units is usually available.
 - Pirate parts are available for major brand names at reduced cost.
 - A jaw crusher is more readily sold in the after market.
 - The components are easier to transport underground.
- Gyratory crushers are employed at most large open pit operations. Additionally, they have been installed underground in some of the larger mines (Kidd Creek, Brunswick, Henderson, El Teniente, Palabora) and for a few open pit and quarry/glory hole operations (Cadomin, Glensada).
- Gyratory crushers offer the following advantages compared to jaw crushers.
 - High capacity (At 3,600 tph, the largest gyratory crusher on the market has three times the capacity of the largest jaw crusher available).
 - Product of uniform dimensions (cubical product better than a slabby one).
 - Ability to flood feed (careful feed regulation not normally required).
 - May usually be started up when fully loaded (choke start).
 - Less power consumption per ton crushed.

25.8 Locating a Primary Crusher Underground

Typically, two potential locations exist for an underground crusher in a mine employing a production shaft.

- Near the shaft
- Under the orebody

Classic mine design employs a crusher near the shaft, which is considered advantageous for steeply dipping ore bodies of simple geometry. In cases where rail haulage is employed in conjunction with a multiple ore pass system, the rail haulage is typically extended to dump above a crusher near the shaft. Placing the crusher in a location near the shaft has also been employed where the configuration of the orebody makes it impossible to place ore passes close enough to the draw points to allow LHD equipment to economically tram the ore. In such a case, haulage trucks are required. If haulage trucks are used, they may as well tram the extra distance required to an ore pass leading to a crusher near the shaft.

An indirect determining factor is the pre-production schedule. A crusher room near the shaft is accessed for excavation more rapidly than one that is remote.

In very deep mines, the crusher should be located near the shaft, well away from the influence of ground stress due to mining activity.

25.9 Dust Collection

Crushers require dust control to meet particulate emission regulations, especially if they are located underground. The water spray (efficiency of 70%) once employed is no longer adequate. Dry fog nozzles (efficiency of 95%) have been employed in plants up to 350 t/hour; however, they require a complete seal around the point of generation that has proven to be difficult. Most crusher installations employ a dust collection system, of which there are two basic types.

- Wet type dust collector (water scrubber) – 93% - 98% efficient
- Dry type dust collector (bag type) – up to 99% efficient

Both types use the same hardware for dust collection, the difference is in the manner of collection and disposal. The dust is "vacuumed" into a duct at each generation point and the ducts are branched into a main duct that leads to the collection system.

In the wet system, the dust-laden airstream is accelerated with a cyclone or venturi and impacted on a wet surface. The waste product accumulates as slurry, which facilitates disposal.

In the dry system, dusty air is passed through a fabric filter at a low velocity. Particles collect on the fabric that must be reconditioned at intervals by vibration or shaking. The pressure drop across the filter fabric generally does not exceed 6 inches water gauge. This system does not work in a humid environment. Dust may be slurried (in a pug mill) for disposal or ducted to the crushed ore bin.

In general, the wet type is preferred because it is less expensive, easier to maintain, and normally requires less excavation; however, certain jurisdictions may require the "lowest achievable emission rate" (L.A.E.R.).

25.10 Crushing Waste Rock

In addition to crushing the ore, many mines crush a substantial amount of waste rock that was stripped from a pit or results from underground development. The product is used at the mine to provide road dressing, concrete aggregate, and underground backfill. Some mines sell surplus crushed rock to local clients as a sideline operation.

Waste rock crushing plants on surface typically incorporate a screening facility to separate the fines and sort the remainder. It is rarely practical to install a separate crushing and screening plant in an underground mine. Underground mines usually direct as much waste rock as possible to supplement the backfill operations rather than move it to the surface. The remainder is either truck hauled to surface, batched (campaigned) through an ore crusher, or sized with a separate rockbreaker circuit.

Underground mines require significant quantities of crushed rock for road dressing (ballast) on lateral haulage ways and ramps. Usually, it is difficult to recover enough desirable waste rock from the materials handling system underground. Moreover, minus 6 or 8 inch material is not particularly suitable for ballast. One practical means of obtaining road dressing underground at the size desired (-2½ inches) is to install a tuning fork grizzly (or similar device) at a suitable location to divert a portion of the undersize material for use as roadbed dressing.

25.11 Rockbreakers

Oversize muck (ore and waste rock) is the cause of hang-ups, feeder problems, crusher jams, and damage to chutes and gates. In hard rock mines, mechanical rockbreakers are used to size lumps of muck in preference to secondary blasting. The rockbreakers may be mobile or stationary for surface operations but are most always pedestal mounted at one location in an underground hard rock mine.

The capacity of a rockbreaker is dependent on the following items.

- Characteristics of the breaker (energy per blow and blows per minute).
- Size of the grizzly (or "Texas gate") openings.
- Amount of oversize in the ore stream.
- Work index and cleavage of the oversize muck to be broken.
- Geometry of the installation.
- Operator ability.
- Visibility (remote operation via camera versus direct).

A capacity of up to 180 tph over a standard 400 by 600 (16 by 24 inch) grizzly has been reported at one underground mine in Northern Quebec. The capacity for bulk mining methods using large LHD equipment is reported as low as 1,000 tonnes per day (tpd) through a similar opening for a three-shift operation at some mines.

The standard grizzly opening (16 inch by 18 inch) is normally employed to size ore for hoisting and is often employed to size waste rock for a conveyor load out to a shaft pocket. A larger opening is employed to feed a crusher (typically and the grizzly opening dimension is made equal to 80% of the gape of the crusher).

Hydraulic rockbreakers (as opposed to pneumatic) are invariably selected for new installations. Despite the higher capital cost, hydraulic breakers have greater capacity and significantly less operating cost. A rockbreaker should normally have a boom reach of at least 6m (20 feet).

If production is increased, it is conceivable that a second rockbreaker may be found desirable at the same location. To prepare for such an event, allowance should be made in the design layout for installing a second rockbreaker at the same grizzly in the future.

26.0 Mineral Processing

26.1 Introduction

Hard rock mines almost always produce metallic ores (as opposed to mines that produce industrial minerals, salt, or coal). The metals are won from the ores of hard rock mines by procedures most often described as “mineral processing.”

The interface between the mine and mill (where the mineral processing is first performed) demands an exchange of knowledge and good communications. For this purpose, the miner must be versed in the basics of mineral processing. The text of this chapter is only a primer to a field of work that is far more extensive than can be adequately addressed in this handbook. Mineral processing procedures are complex and difficult to describe in simple terms. There are exceptions to be found to any general observation and the processes commonly employed are constantly changing due to technical advances and environmental concerns. In this chapter, license was taken in some cases from true science and proper terminology to facilitate a basic understanding by the miner.

Mineral processing may be divided into three distinct phases.

- Comminution (crushing and grinding)
- Beneficiation (separation and concentration)
- Smelting and refining

Comminution

Crushing was dealt with in Chapter 25; comminution in this chapter deals with grinding the ore to a fine particle size to facilitate subsequent processing.

Beneficiation

Beneficiation of hard rock ores may be separated into two fundamental processes – one for noble metals and the other for base metals.

Noble Metals

The first deals with the noble (“precious”) metals, such as gold and silver that are relatively inert and often occur as fine particles of native metal in the ore. Noble metals are typically separated by gravity and/or leached from the ore (dissolved in a weak cyanide solution), and then precipitated or adsorbed and refined at the minesite to produce bars of bullion. These ingots are later further refined elsewhere to separate and purify the contained metals. Gold ores that may be treated in this manner are referred to as “free milling.”

Base Metals

The second deals with base metals, such as copper, lead, zinc, and nickel that usually occur in a chemical compound from which they cannot be separated in the mill. Instead, the mill separates the compound(s) from the ore by flotation to produce “concentrate(s),” which is the typical product from a base metal mine. The concentrates are then transported to a smelter and refinery that are usually a long distance away.

The concentrates often contain small quantities of precious metals (enhancing value) and may contain undesirable impurities, such as mercury or arsenic (reducing value). The premium paid by smelters for precious metal content is referred to as a “credit” and the reduction in payment because of impurities (or high moisture content) is most often called a “penalty.”

Base metal compounds are typically sulfides and most often occur in the ore along with other (unwanted) iron sulfide compounds, such as pyrite, marcasite, pyrrhotite, and arsenopyrite. Base metal ores from near the surface may have had the sulfide compounds converted to oxides by the force of nature. The oxide zone of a base metal deposit in hard rock is typically only in the order of 10 feet (3m) deep; however, there are cases where the oxidation penetrates to a depth of over 400 feet (120m). Oxide ores (particularly partially oxidized ores or “over-oxidized” ores that contain a native base metal) represent a challenge for the mill, which is normally designed to be efficient in dealing only with sulfide ores. On the other hand, oxide ores lend themselves to very economical extraction by direct leaching (for gold and silver) or SX-EW. At hard rock mines, the latter procedure is still mainly confined to copper ores. Operations that mine laterites (soft oxide ores of metals such as nickel and aluminum) are not considered to be hard rock mines.

Smelting and Refining

Since smelting and refining generally take place away from the minesite, these aspects of mineral processing are not pursued in this chapter.

Note

Hard rock miners use the same word ("mill") to describe both the entire mineral processing plant (concentrator) and a machine used in this plant to pulverize the ore by tumbling it in a rotating drum. To avoid confusion in the text that follows, an adjective precedes the word mill (grinding mill, ball mill, or autogenous mill) when referring to the machine.

26.2 Rules of Thumb**General**

- A concentrator (mill) requires up to 3 tons of water for each ton of ore processed. It is therefore important to operate with the maximum practical pulp density and minimum practical upward or horizontal movement. The basic philosophy requires movement over the shortest possible distances between processing units and makes use of gravity to save on power consumption. *Source:* Wayne Gould
- In the arid climates, mills operate with less than one ton of new water for each ton of ore processed. The balance of the process water required is recovered from dewatering concentrate, thickening the tails, and re-circulation from tailing ponds. *Source:* Norman Weiss
- A mill at the mine (and related facilities) accounts for approximately 85% of the total electrical power consumption for an open pit operation, but only about 45% for a typical underground mine. *Source:* Alan O'Hara
- For a typical underground mine, the cost for electrical power for the mill (concentrator) will be approximately 35% of the total electrical power cost for the mine. *Source:* Fred Nabb
- The minimum slope of concrete floors in the mill is 3/8 inch/foot (3%), more around grinding mills where slurry spills can be frequent events. *Source:* Bob Shoemaker
- Each hour of downtime in a mill is equivalent to a 4% decrease in recovery that day. *Source:* Bob Shoemaker
- A mill built entirely of second-hand equipment and controls may be constructed for half the cost of one built "all new" with state-of-the-art automated monitoring and controls. *Source:* Bruce Cunningham-Dunlop

Grinding

- Fine ore bins (or stockpiles) that provide feed to the grinding circuit should have a capacity equal to 30 hours of processing. *Source:* Northern Miner Press
- Grinding is a low-efficiency, power-intensive process and typically can account for up to 40% of the direct operating cost of the mineral processing plant. *Source:* Callow and Kenyen
- For purposes of design, it may be assumed that a ball mill will carry a 40% charge of steel balls; however, the drive should be designed for a charge of 45%. *Source:* Denver Equipment Company
- A grate (diaphragm) discharge ball mill will consume 15% more power than an overflow (open) discharge ball mill even though the grinding efficiencies are the same. *Source:* Lewis, Coburn, and Bhappu
- Other things being equal, the larger diameter the drum, the more efficient the grinding. However, this phenomenon stops when the diameter reaches 12.5 feet (3.8m). Thereafter, the efficiency bears no relation to diameter. *Source:* Callow and Kenyen
- The ball mill diameter should not exceed 100 times the diameter of the grinding media. *Source:* Bond and Myers
- In pebble mills, the individual pieces of media should be the same weight, not the same volume, as the optimum size of steel ball. *Source:* Bunting Crocker
- The power draft (draw) in a pebble mill can easily, quickly, and automatically be controlled to an extent that cannot be done on a ball mill. *Source:* Bunting Crocker
- The ratio of length to diameter of a rod mill should not exceed 1.4:1 and the maximum length of a rod (to avoid bending) is 20 feet. As a result, the largest rod mill manufactured measures fifteen feet diameter and is 21 feet in length. *Source:* Lewis, Coburn, and Bhappu
- For most applications, 70:1 is the maximum practical reduction factor (ratio) for a ball mill, but 60:1 represents typical design practice. *Source:* Jack de la Vergne
- Rubber liners in ball mills may have a service life of 2-3 times that of steel liners. *Source:* W. N. Wallinger

Grinding (continued)

- The capacity of a mill with synthetic rubber liners is approximately 90% that of the same unit with steel liners. *Source:* Yanko Tirado
- The capacity of a grinding mill for a given product operating in open circuit is only 80% that of the same unit operating in closed circuit. *Source:* Lewis, Coburn and Bhappu.
- A dual drive (i.e. twin motors and pinions driving a single ring gear) may be more economical than a single drive when the grinding mill is designed to draw more than 6,000 HP (4.5 Mw). *Source:* Rowland and Kjos
- Geared drives are currently available up to 9,500HP. *Source:* Barrat and Pfeifer
- A direct drive ring motor (gearless drive) is the only option for an autogenous mill rated over 20,000 HP. *Source:* Mac Brodie

Classifiers

- The ratio of diameters between the vortex finder (overflow exit) and the apex (underflow exit) of a hydrocyclone classifier must be kept greater than 2:1, otherwise operation may be unpredictable. *Source:* Chuck Lagergren and Gary Lubers

Gravity Separation

- For gravity separation to be possible, the ratio of the difference in density of the heavy mineral and the medium and the difference between the light mineral and the medium must be greater than 1.25. *Source:* Arthur Taggart
- Most all wet gravity separation equipment is sensitive to the presence of slimes (minus 400 mesh). Slimes in excess of 5% should be avoided. More than 10% causes serious separation problems. *Source:* Chris Mills

Leaching

- The actual cyanide consumption at a heap leach operation will be no more than one-third the rate indicated by column leach tests. *Source:* Tim Arnold

Flotation

- Clean metallic gold particles (free gold) finer than 200 microns (65 mesh) float readily with appropriate reagents. Gravity separation is desirable for larger particles. *Source:* Mining Chemicals Handbook (Cyanamid)
- When designing the flotation circuit for a proposed mill, the scale-up factor for flotation retention times obtained from bench tests is approximately two. *Source:* Mining Chemicals Handbook (Cyanamid)
- To determine a preliminary water balance for a proposed flotation circuit, the pulp density may be assumed to be 30% solids (by weight). *Source:* Rex Bull
- As a rule, water-soluble collectors may be added anywhere in the circuit, but oily, insoluble promoters should always be added to the grinding mill. *Source:* Keith Suttill
- For roasting to be exothermic to the extent that no fuel is required to sustain reaction, the flotation product must contain at least 17% sulfur. Therefore, the target is 18%. *Source:* Dickson and Reid

Filtration

- When designing the filters required for a proposed mill, the scale-up factor from bench tests is approximately 0.8. *Source:* Donald Dahlstrom
- When determining vacuum pumps for filter installations required for a proposed mill, the scale-up factor from bench tests is approximately 1.1. *Source:* Donald Dahlstrom

Concentrate

- The typical moisture content of concentrates shipped from the mine is often near 5%. If the moisture content is less than 4%, the potential for dust losses becomes significant. *Source:* Ken Kolthammer
 - The moisture content of concentrate measured by a custom smelter will invariably be 1% higher than was correctly measured by the mine when it was shipped. *Source:* Edouardo Escala
-

Concentrate (continued)

- If the moisture content of the concentrate is above 8%, problems with sintering and combustion are usually avoided. Unfortunately, concentrates stored in a cold climate generally require maximum moisture content of 5% to avoid handling problems when frozen. Concentrate subject to both spontaneous combustion and a cold climate are usually dried to less than 4% and sometimes as dry as ½%. *Source:* Ken Kolthammer

Leach

- The gold leaching recovery process requires dissolved oxygen in the leach solution to be efficient. This may be accomplished with air sparging when the oxygen uptake rate is 2 mg/liter/minute or less. Otherwise, oxygen injection is required. *Source:* Damian Connelly
-

26.3 Tricks of the Trade

- To calculate the area (acres) required to be cleared for construction of a mill and associated structures, simply divide the square root of the number for the daily tonnage of ore to be milled by 20. For example, a proposed 6,400-tpd mill will require $80/20 = 4$ acres of land to be cleared. *Source:* Alan O'Hara
- To roughly calculate the quantity (cubic yards) of concrete required for a mill (not including a crusher house) to be built on a firm strata, multiply the square root of the number for the daily tonnage of ore to be milled by 60. For example, a proposed 1,600 tpd mill will require in the order of $40 \times 60 = 2,400$ cubic yards of concrete to be poured. *Source:* Jack de la Vergne
- To roughly calculate the power consumption in kWh/tonne of a proposed mill for a medium sized mine, add 15 to the number for the Bond W_i of the ore. For example, if $W_i = 13$, the power consumption will be approximately 28 kWh/tonne processed. Due to economy of scale, add only 10 to the W_i for a huge open pit copper mine, but add 20 for a small gold mine. (For more accuracy, refer to Chapter 23 – Electrical.) *Source:* Jack de la Vergne
- The Sixth-tenths Rule may be used to quickly obtain a rough estimate of the cost of building a proposed mill when the cost of a mill of different capacity processing the same mineral(s) is known and escalated to date. *Reference:* refer to Chapter 8 – Cost Estimating
- Jack's Rule may be used to quickly obtain a rough estimate of the cost of building a proposed mill when the cost of a mill of similar capacity processing a different mineral(s) is known and escalated to date. *Reference:* refer to Chapter 8 – Cost Estimating
- The design of a new concentrator should consider provision to receive crushed ore for custom milling (or from a satellite operation) even though none is contemplated at the outset. *Source:* Jack de la Vergne
- The design of a new concentrator should consider that mills are almost always expanded after initial operation. *Source:* Bob Shoemaker
- To quickly estimate the size of a ball mill required for a proposed installation, first determine the drive HP and then select a corresponding mill size from manufacturer's catalogues. The drive HP is calculated using Bond's formula (see text). Then apply an assumed efficiency of 70-75%. *Various Sources*
- The drive efficiency of a smaller grinding mill with a typical induction motor drive can be quickly measured while it is operating by placing the prongs of a hand held ammeter around one of the feed cables. The value obtained is multiplied by $\sqrt{3}$ and again by the supply voltage to obtain power. The power value obtained (kW) divided by 0.7456 gives the actual horsepower draw to be compared with the nameplate horsepower of the motor drive to obtain the drive efficiency. *Source:* Unknown
- An operator can (and often does) raise the capacity of a grinding mill by increasing its speed (RPM) beyond the optimum, but the price paid is higher power consumption per ton processed. *Source:* Lewis, Coburn, and Bhappu
- An indicator of good ball wear is when the worn out balls discharging from the drum are 16mm (5/8 inch) or smaller in size and are polygon shaped having as many as 12 surfaces that can be slightly concave. *Source:* Rowland and Kjos
- A neat way to sample the pulp density of a ball mill is to install a 3-inch x 3-inch angle iron open side up so that it acts as a V-shaped launder to collect a small portion of the flow from underneath the discharge trommel. The sample is collected at will from the lower end where the stream drops into a funnel connected to a small pipe leading to the cyclone feed sump. *Source:* Bob Shoemaker
- A sloping channel iron should be attached near the top edge of the foundations of grinding mills and their drive motors (like the rain gutter on a house) to catch any oil leaks and direct them down a pipe to an approved portable container on the floor. *Source:* Bob Shoemaker

- If a grinding mill is to be shut down for a long period of time, it should be emptied of the grinding medium and liners (if steel); otherwise, a permanent set can develop in journal (babbit) bearings. *Source:* Bob Dengler
- When the nature of the ore permits, it is more economical to grind all the ore just enough to partially liberate the mineral, then fine grind (regrind) only that portion of the ore that has reported to the rougher concentrate. *Various Sources*
- A Hydrocyclone classifier should be equipped with a manual hydraulic adjustment of the apex valve. *Source:* Leon Dotson
- To avoid blockage, slurry lines are better laid horizontal and vertical rather than on a slope. It's even more important with piping used for pneumatic transport. *Source:* Bob Shoemaker.
- The relatively good copper recovery (95%) and clean concentrate (28.5 % Cu) at Granduc was partially due to the high temperature (30 degrees C.) of the flotation pulp. This was made possible because the cooling water from the power plant was used for process water. *Source:* J.J.M. Meyknecht
- Contrary to traditional beliefs that can be traced to an erroneous report on tests carried out by the USBM many years ago, lime does not depress gold in a flotation circuit when added in amounts up to 8 kg/tonne. Lime is less expensive than soda ash and it has a flocculating effect on iron oxide slimes, tending to depress them. *Source:* Fernando Benitez
- Gangue minerals should be scheduled along with metals. For example, excessive pyrite has the end effect of reducing the recoveries of lead and zinc into the concentrate, while silica impacts on the quality of zinc concentrate produced, downgrading its marketability. *Source:* Frank Kaeschager
- Two types of separation circuits can be used in various combinations to generate separate concentrates in the flotation of a multiple sulfide (polymetallic) ore: differential and bulk selective. The latter is generally about half the cost but differential flotation provides better performance because it is always easier to reactivate a depressed mineral than it is to depress an already "active" one. *Source:* John A. Meech
- A significant capital cost saving results from constructing a thickener in-ground (with a plastic liner). *Source:* Harbour Lights Mine
- Too much froth in a secondary flotation circuit resulting from the re-circulation of mill water may be overcome with the addition of activated carbon. *Source:* Brooks and Barnett
- Hot vulcanizing in a rubber shop is the solution to the problem of separation of cold-bonded rubber linings in pipes, launders, pump boxes, etc. *Source:* W. N. Wallinger
- The problem of wood chips in return water can be overcome by installing a slightly submerged overflow in the thickener (drill some holes in the overflow launder). *Source:* G. Hawthorne
- In most cases, it is not economical to dry the concentrate more than 1% less than the moisture content that will incur an extra penalty at a custom smelter in the vicinity of the mine. *Source:* Rex Bull
- The recovery of gold from cyanide (pregnant leach) solution with activated carbon is usually the economical choice. A carbon in pulp (CIP) or carbon in leach (CIL) circuit is just as efficient and is typically installed for 65-85% of the capital cost and run at 80-90% of the operating cost incurred with a traditional zinc precipitation (Merrill-Crowe) installation. However, these economies do not hold true for a small mill (or a larger mill treating rich gold ore). *Source:* John Wells
- The traditional Merrill-Crowe zinc precipitation process should be considered instead of CIP or CIL when the gold ore contains significant quantities of silver; otherwise the recovery of this metal will be halved. *Source:* Paul Chamberlin
- When "preg-robbing" (tendency to absorb gold from a cyanide solution) carbon or carbonaceous compounds (typically from graphitic shales) that occur in gold ore, recovery may be substantially reduced if the ore is treated as if it were free milling or simply refractory. In some cases, the "carbons" may be effectively removed (before leaching) by selective flotation, using diesel fuel or kerosene passivation. In other circumstances, roasting of a gold concentrate is the practical procedure. *Various Sources*
- Lime bins are commonly designed in a conical shape with small bottom openings, which is a sure way to get a plugged bin. The only solution that will work is to install a vibrating bin bottom. *Source:* Bob Shoemaker
- A security problem often exists when transferring out gold bullion bars from a remote minesite in a developing country. A safe method is by helicopter, provided there is no fixed routine to the flight schedules. *Source:* Bruce Winfield

- Because of the security problems associated with gold bullion at a remote site in a developing country, consideration should be given (where the ore is amenable) to producing a flotation concentrate instead. The concentrate may be shipped out safely for further processing or sold directly to a custom smelter (who may pay a credit for a contained base metal that would otherwise be lost). *Source:* Jack de la Vergne

More tricks of the trade can be found in Robert Shoemaker's book, "The Circulating Load," SME Publications, 2002, ISBN 0-87335-218-1.

26.4 Grinding

Hard rock mine ores are invariably pulverized to a size small enough to liberate mineral particles from the barren rock (gangue). This comminution is ordinarily the first step that takes place within the mineral processing plant.

A number of grinding mill types are employed for hard rock mines. The classic grinding circuit consisted of a rod mill followed by a ball mill(s) in a two-stage circuit. This arrangement is still found at older installations and some newer ones that were built with used equipment.

A Semi-Autogenous Grinding (SAG) mill followed by a ball (or sometimes a pebble) mill(s) is the common arrangement found in modern plants of medium to large size in North America. Smaller mines often employ an extra stage of crushing to create product small enough to permit single stage grinding with a ball mill(s).

For these reasons, only autogenous mills and ball mills are further described in this chapter.

Ball Mills

The ball mill remains the most widely used grinding unit at hard rock mines.

The drum of a primary ball mill is typically cylindrical and of length equal to or up to 65% longer than its diameter. A number of even longer mills and conical mills have been manufactured in the past on the thesis that these designs better enable classification of the ground ore as it passes through the mill.

The grinding action is obtained by rotating the drum so that forged (or cast) manganese alloy steel balls (or cast iron slugs) are cascaded and tumbled with the ore. The ore is ground between balls and normally between balls and a steel liner. Over a period of time, the balls wear to a smaller diameter so that at any one time there is a gradation in the size. The average gradation is maintained by the regular addition of new ("green") balls. In the past, steel balls had diameters ranging between two and three inches (depending on the drum diameter). Today, steel balls with four-inch diameters and more may be employed in larger diameter ball mills. The quantity (charge) of steel balls in the ball mill may range from 35 to 45% of the volume within. A mixture of crushed ore and water fills the space between and around the balls, such that the rotating drum is approximately half full. The pulp (crushed ore and water) in a ball mill is held near 75% solids (by weight).

The ball mill typically operates in closed circuit, meaning that a portion of its output (containing coarse ground ore) is recycled through the drum to be ground down to size. This recycling is a dynamic process in which pulp goes through the ball mill several times (on average). Between 2¼ and 2¾ times (225 - 275% re-circulation) is nominal; however, there are installations where the re-circulation exceeds 500%. Separating the coarse fraction of the ground ore to be returned to the ball mill is normally accomplished in a hydro-cyclone classifier. Rake classifiers and spiral classifiers are virtually obsolete, mostly due to the space required. Because it has no moving parts, the cyclone classifier requires little maintenance, but it consumes more power because the pulp must be pumped up to it at sufficient velocity to maintain 10 psi (70 kPa) or more of head at the entrance for proper performance.

The nominal product from a ball mill is considered to be 80% -200 mesh. Larger particle size is termed a coarse grind while smaller sized product is referred to as a fine grind.

Case History

The world's largest ball mills are the two installed at the 72,000 tpd Donde de Collahuasi mine in Chile. Each mill measures 22 feet in diameter by 36 feet in length and has a 12,500 HP shell drive. (The same mine has twin 10,500 HP SAG mills 33 feet in diameter by 15 feet long.)

Autogenous Mills

A few of the larger mines have been successful employing a Full Autogenous Grinding (FAG or AG) mill (the larger chunks of crushed ore act as the grinding medium). This type of mill is very appealing (especially for a remote minesite), since it avoids the cost of purchasing, shipping, and handling grinding balls; however, it is only suitable for very hard ores with cubic cleavage. It is often extremely difficult to determine in advance whether a particular ore will work properly in a FAG mill.

A SAG mill can be described as a FAG mill that did not work properly with ore as the only grinding medium; therefore, steel balls were added. The ball charge is only about one-third of that required for a ball mill (usually 10-15% compared with approximately 40%).

The efficiency of a grinding mill depends on the weight of the grinding medium. This means that FAG and SAG (autogenous) mills are required to be of larger dimensions than a comparable ball mill because steel is 2½ to 3 times as heavy as the ore

from a hard rock mine. However, the power consumption is similar, although some efficiency is lost in an autogenous mill because they typically require a grate (diaphragm) discharge to retain the coarse grinding medium while most ball mills have an open (overflow) discharge.

The drum diameter of an autogenous (FAG or SAG) mill manufactured in recent years on this side of the world is typically about equal to twice its length.

For an autogenous mill to be most efficient, an optimum ore feed size related to the diameter of the mill can be determined using the following formula.

$$F = d_{80} \text{ feed (optimum)} = 0.95D^{2/3}$$

(Source: MacPherson and Turner)

Where d_{80} = size of opening (inches) through which 80% of the feed will pass.

D = the diameter inside the liners, measured in feet.

Example

1. Find the optimum feed size for a SAG mill 26 feet in diameter.
2. Find the open-side (o/s) setting of an underground crusher to obtain this feed on surface, assuming an attrition of ½ inch in the transport and storage of ore between the underground crusher and the SAG mill.

- Facts:
1. D = 26 feet
 2. Attrition = ½ inch
 3. The product of this crusher is ½ inch less than the open side setting

- Solutions:
- Optimum d_{80} Feed Size = $0.95 \times 26^{2/3} = 8\frac{1}{2}$ inches
- Open-side setting (o/s) = $8\frac{1}{2} + \frac{1}{2} + \frac{1}{2} = 9\frac{1}{2}$ inches

Case History

For many years, the world's largest autogenous mill was an Allis-Chalmers 12,000 HP FAG mill 36 feet in diameter by 15 feet long, installed at Hibbing, Minnesota. Recently, a Metso 20MW SAG mill 40 feet in diameter by 22-foot long was installed at Newcrest's Cadia mill in New South Wales, Australia.

Grinding Mills (Autogenous Mills and Ball Mills)

Critical Speed and Optimum Speed

The critical speed, C_s (measured in RPM) is when the centrifugal force on the grinding mill charge is equal to the force of gravity so that the charge clings to the mill liners and will not tumble as the drum rotates. C_s is calculated using the following formula.

$$C_s = 76.63\sqrt{D}$$

Where D = the diameter inside the liners, measured in feet.

Optimum crushing efficiency is obtained when a grinding mill is run at a particular fraction of critical speed. It is often reported in the literature that the optimum speed is near 75% of critical. This is true of a ball mill that is 10 feet (3m) diameter, but the optimum speed is greater for a smaller diameter ball mill (80% for a 3-foot diameter ball mill). Optimum speed is typically less than 75% for one of larger diameter (as low as 65% for a 20-foot diameter ball mill).

Bond's Law

During the 1940's, Fred Bond (largely in association with W. L. Maxon) developed a system for comparing ore grindability in terms of weight passing a specific mesh size per revolution of the grinding mill. Since that time, others have developed similar analyses, but the original system prevails today for grinding mills (and may also be used for crushers).

Bond's formula is conveniently expressed as follows.

$$W = Wi (10/\sqrt{P} - 10/\sqrt{F})$$

W = work (kWh/short ton ore)

P= size in microns (μ) through which 80% of the product passes (P_{80})

Wi = work index

F= size in microns (μ) through which 80% of the feed passes (F_{80})

Bond's formula contains a mixture of metric and imperial units. To convert to all metric, the denominators (10) are simply changed to 11 to obtain the result in kWh/metric ton (tonne).

$$W = Wi (11/\sqrt{P} - 11/\sqrt{F})$$

Some metallurgists add modification factors to the Bond formula in comprehensive calculations to obtain greater accuracy.

Table 26-1 provides typical work indices for some common rocks and minerals. For purposes of designing a proposed grinding mill, the work index of the ore to be treated is obtained from laboratory test reports.

Table 26-1 Bond Work Index for Rocks and Minerals

Rock	Wi	Mineral	Wi
Andesite	22	Feldspar	12
Basalt	20	Garnet	12
Diorite	19	Graphite	45
Dolomite	11	Hematite	13
Gabbro	18	Limonite	8
Gneiss	20	Mica	135
Granite	14	Quartz	13
Limestone	11	Silica	14
Quartzite	12		
Sandstone	12		

Table 26-2 provides particle sizes in microns (μ) required for use in the Bond formula.

Table 26-2 Feed and Product Sizes in Microns (μ)

Coarse Feed or Product				Fine Feed or Product (screened)		
Grizzly Opening	Crusher Open-side Setting	d_{80} (80% passing)		d_{80} (80% passing)		
		Inches	Microns (μ)	U.S. Sieve	Tyler	Microns (μ)
36 by 36	-	32.20	817,900	No. 4	4 mesh	4,760
30 by 30	-	26.80	681,600	No. 6	6 mesh	3,360
24 by 24	-	21.50	545,200	No. 8	8 mesh	2,380
18 by 18	-	16.10	408,900	No. 12	10 mesh	1,680
12 by 12	-	10.70	272,600	No. 16	14 mesh	1,190
-	10	9.50	240,200	No. 20	20 mesh	841
-	8	7.60	192,200	No. 30	28 mesh	594
-	6	5.70	144,100	No. 40	35 mesh	420
-	5	4.70	120,100	No. 50	48 mesh	297
-	4	3.80	96,100	No. 70	65 mesh	210
-	3	2.80	72,000	No. 100	100 mesh	177
-	2	1.90	48,000	No. 140	150 mesh	149
-	1	0.95	24,000	No. 200	200 mesh	74
-	3/4	0.71	18,000	No. 270	270 mesh	53
-	5/8	0.59	15,000	No. 325	325 mesh	44

($1\mu = 1 \times 10^{-6}m$)

Bond's Law Example

Calculate the reduction ratio and estimate the power consumption of a ball mill, using the Bond formula.

- Facts: 1. F, the feed is from a cone crusher with a 5/8-inch open side setting
1. P, the product desired is 70% passing a Tyler 65 mesh screen ($P_{70} = 65$ mesh)
 2. W_i of the ore to be ground is 15

- Solution: 1. From the Feed and Product Size Table, the feed, $F_{80} = 15,000\mu$ for a 5/8 inch open-side setting.
2. From the Feed and Product Size Table, a product, $P_{80} = 210\mu$ for 65 mesh.
 3. The desired product size, $P_{70} = 210 \times (80/70)^2 = 274\mu$ for 65 mesh.
 4. Reduction ratio = $F/P = 15,000/274 = 55$ (55:1).
 5. Power, $W = W_i (10/\sqrt{P} - 10/\sqrt{F}) = 150(1/\sqrt{274} - 1/\sqrt{15,000}) = 7.8$ (7.8 kWh/short ton).

Controls

The efficiency of a grinding mill is dependent not only on the optimum RPM of the drum, but also the ball charge and the rate and blend of feed. These multiple variables make it difficult even for seasoned operators to manually maintain optimum efficiency in the grinding circuit. When the efficiency of a dynamic process is dependent on multiple variables, computerized controls and simulation modeling are advantageous. Computers have controlled grinding circuits in some mills for over 20 years. These controls are credited with increasing the efficiency of grinding circuits by 5% and more.

Shutdown and Salvage

A large value of gold may be recovered from a grinding mill that has operated for many years in a mine containing gold in the ore. Ores containing gold often contain minute amounts of mercury, silver chloride, etc. that are released in the milling process. Gold combines with these materials (or remains as elemental gold) and collects as a crude amalgam in every crevice and surface in the grinding mill (not subject to direct abrasion). The amalgam is invisible because it is the same color as steel; however, the amalgam is softer and can be readily identified and removed with a hammer and cold chisel. After removal, mercury, soda ash, and lead nitrate are added to the amalgam, which is then ground and pressed to remove excess mercury. The compressed material may be then put in a laboratory retort to distill off (and recover) mercury and leave behind a dirty sponge of gold to be washed and refined.

26.5 Beneficiation

At hard rock mines, numerous methods are employed to separate and concentrate the ore (beneficiation). The most common methods are flotation, leaching, gravity separation, and solvent extraction. The most widely employed is flotation. For ores of many metals, flotation is used exclusively, for some it is employed in conjunction with another method, most often gravity separation. The most common application for precious metal ores is leaching. Solvent extraction is usually peculiar to uranium ores and copper oxide ores. This chapter further describes flotation, leaching of precious metals, and gravity separation. Solvent extraction is dealt with only as it relates to the recovery of copper.

Flotation

Due to surface tension, a tiny flake of gold can float in a glass of water despite the fact that gold is almost twenty times as heavy as water. If the water is stirred vigorously with a spoon after a few drops each of pine oil and creosote (reagents) are added, a minute ($<75\mu$) gold particle will usually rise and float in the thin surface foam (froth). This occurs because gold is naturally hydrophobic (not wetted by water) and because the reagents make the tiny gold particle more water-repellant and bubble attractive. Commercial flotation exploits and enhances this phenomenon to float (and skim off) fine particles of gold in unusual circumstances, such as when fine gold is contained in a cyanogenic (over-oxidized) gangue or freely associated with other minerals (to be recovered by the same process).

Base metal minerals are much more amenable than gold to this same procedure and they constitute by far the most common application for recovery by flotation. These minerals (usually sulfides) occur as particles (separated by the grinding process) that are recovered by the same process of flotation from "pulp" (a mixture of finely ground ore and water).

In some cases, flotation is used to remove an unwanted mineral component from the pulp.

Reagents usually work better in an alkaline pulp; therefore, a pH regulator (usually lime) is typically added before the reagents are meted out. The reagents used are mainly the following proprietary chemical compounds.

- A frother (pine oil is a simple frothing agent with some collecting powers)
- A collector and promoter (combined in one agent or provided separately)
- A modifier (which may have one of any number of functions)

Air is a necessary component of the flotation procedure. Slightly compressed air is blown into the cells providing agitation and a thicker froth (bigger bubbles). Some mills once employed simple mechanical agitation (analogous to stirring with a spoon), because too much air was deemed detrimental to flotation efficiency in their particular case.

Selective flotation refers to floating one mineral while leaving behind (depressing) another. Differential flotation refers to selective flotation of different economic minerals in succession from a poly-metallic ore.

In an elementary flotation circuit, the pulp is "conditioned" with reagents before flowing continuously through one bank of cells (tier of connected, open tanks) and then to another bank. The float is continuously skimmed off in each cell. The skimmed float from the first stage of cells (roughers) is typically combined with float from a second stage (scavengers) and directed to a third stage (cleaners) where it is re-floated to produce a slurry of nearly pure mineral (concentrate or "cons"). The slurry is subsequently dewatered and dried to make the final concentrate that is then suitable as smelter feed.

The barren pulp ("tails") from which the mineral has been won is partially dewatered and piped from the mill for further dewatering and permanent disposal in a tailings impoundment or sometimes used as backfill in empty underground stopes (as a component of paste fill or hydraulic fill).

In new mills, the flotation cells are larger (the silting problem having been solved). Often, the traditional rectangular tank cells in the cleaning phase are replaced with erect cylindrical tanks (column flotation). These advances save space, facilitate monitoring, and reduce maintenance costs; however, there is a practical limit to the size of cells to prevent short-circuit and maintain flexibility. The larger the mill capacity, the larger the cells.

As is the case with grinding, modern flotation circuits are equipped with computerized controls to regulate and monitor variables, such as grind, pH, reagent feed, conditioning residence time, cell retention time, and pulp density.

Leaching of Precious Metals

Mines most often separate and recover noble metals, such as gold (and the silver that is normally found with the gold) by gravity and/or cyanide leaching.

Gravity concentration is used almost exclusively when placer mining. Some hard rock mine mills use gravity as a preliminary step in the recovery procedure, but for many it is either inefficient (because of minute gold particle size) or not desired (because it is perceived to facilitate theft).

In the normal (free milling) process, the ground ore is treated (leached) with a dilute alkaline (high pH) solution of sodium cyanide (NaCN). The solution is made alkaline with addition of generous quantities of hydrated lime (quick lime). The cyanide reacts chemically with the gold to form a soluble compound, $\text{Au}(\text{CN})_2$. The solution containing gold is called pregnant or simply "preg."

Subsequently, the pregnant solution may be clarified and the gold directly precipitated with zinc powder (traditional Merrill-Crowe process). The precipitate is then filtered (pressed) and then the compacted precipitate is smelted on-site to produce bars of bullion.

More commonly, the $\text{Au}(\text{CN})_2$ is adsorbed by pellets of activated carbon that are later separated by screening. The pellets are then flushed with a hot (230-266 degrees F) alkaline cyanide solution to dissolve (strip) the gold. The dissolved gold is typically recovered from the resulting rich solution by electrolysis ("electrowinning").

The cyanide solution from which the gold was precipitated (or the loaded carbon was separated) is termed barren and is recycled. So are stripped carbon pellets (which are first re-activated in a kiln).

When the loading of the carbon takes place subsequently and separately from leaching, the process is called CIP. Loading coincident with leaching (short circuit) is called CIL.

Some gold ores are not free milling. In rare instances, the gold in the ore is found to be chemically combined (tellurides) and more commonly found locked into sulfide crystals ("refractory"). Refractory ores are amenable to flotation and the concentrate obtained then subjected to a process (roasting, biological leaching or autoclaving) that reduces the crystalline sulfides to oxides that may subsequently be efficiently leached with cyanide.

Cyanide was the leaching agent of choice for a century despite the fact that it is expensive and lethal if swallowed. Substitutes exist, but none have thus far proven effective and practical. Cyanide is at least 1,000 times more toxic to fish than it is to humans and animals. Dead fish in a river after an accidental spill does not mean the water is poisonous to other fauna. Only one recorded accidental fatality occurred from cyanide poisoning in the mining industry in the whole of the 20th century. Nevertheless, cyanide is now outlawed or otherwise forbidden in some jurisdictions and this may be the beginning of an unfortunate trend. The good news is that some trees (willow family) thrive on a weak cyanide solution. Very efficiently, they consume it like fertilizer and turn it into an essential amino acid (asparagine). Research continues.

Gravity Separation

Gravity separation is the oldest and apparently the simplest means of concentrating ores. Gravity separation is often defined as the separation of coarse particles of metal or mineral; however, this is not always the case. Artificial gravity (centrifugal force) can enable the separation of fine particles in a centrifuge or cyclone.

To comprehend gravity separation, it is necessary to understand that a difference in weight alone (differential SG) is not the only consideration for separation in a dynamic process. Particle size plays an equally important role, as does the medium in which the particles are suspended (air, water, brine, or heavy media). A dense particle (high SG) of tiny size may have the same amount of movement in a fluid media as a different larger particle that is lighter (lower SG). It follows that for a difference in specific gravity to be effective, all the particles should be nearly the same size. Conversely, artificial gravity may be employed to separate particles of similar specific gravity but different particle size ("classification"). This is the operating principle of the hydro-cyclone classifier that re-circulates the coarse fraction of ground pulp back into a ball mill, as previously described.

Besides centrifuges and cyclones, all sorts of machines are used for gravity separation, including sluices, jigs, cones, shaking tables, spirals, and heavy media separation.

Solvent Extraction (SX) for Copper Recovery

When a long abandoned underground copper mine is dewatered, a strange phenomenon may be observed. Pieces of mining equipment left behind (such as an old mine car) have turned into to what appears to be pure copper! (Actually, the purity is around 70%.) Remnant sulfides made the mine water acid (sulfuric acid) that in turn "dissolved" remnant copper ore that resulted in a solution containing copper sulfate (CuSO_4). Since copper ions have a higher valence than iron, the metal equipment was in turn gradually "dissolved" and replaced by deposition of copper. This is the essence of solvent extraction and recovery.

Today, Chile is known for its huge open-pit copper mines, but at one time, much smaller underground operations prevailed. In fact, the mining areas are riddled with long abandoned minesites. About twenty-five years ago, some enterprising mining personnel initiated a popular weekend pastime. After locating a waste rock dump (that contained some ore) they would leach it with sulfuric acid and direct the drainage to a pit they filled with scrap iron. On the weekends, they would recover the copper that replaced the iron and sell it for a handsome profit.

Then, a mining company (Sociedad Minera Pudahuel Ltda.) researched the procedure and came up with a method that recycled the reagents and eliminated the obvious environmental problem. They neutralized the acid leach solution and added a special type of kerosene that "extracted" the dissolved copper sulfate in a "mixer-settler" arrangement. The loaded kerosene was then easily separated (since it is lighter than water). In a subsequent process, the copper was "stripped" from the kerosene into another acidic solution (and the kerosene recycled). This solution was directed to a tank house where it was deposited on thin copper plates to produce thick copper plates ("cathode copper") that were almost 100% pure. This refining process is termed "electro-winning" (EW), and the whole procedure is called SX-EW.

SX-EW was then applied (with great success) to low-grade waste heaps at large open pit operations and later to a huge new mining project (Quebrada Blanca).

Today the procedure of solvent extraction is a highly developed (and complicated) science resulting in a very efficient process that optimizes recovery and produces copper that is 99.9% pure.

27.0 Infrastructure and Transportation

27.1 Introduction

The following chapter discusses mine infrastructure and transportation and is intended to assist those engaged in the planning, design, and construction of new mining projects.

Mine infrastructure is defined as the operations and utilities supporting mining operations. Infrastructure includes administrative offices, employee housing, roadways, railways, airports, security, etc. Mine haulage roads are included in this section even though roads are not normally described as infrastructure. Some infrastructure items that deal with mine layout, water supply, sewage disposal, and surface drainage are discussed in Chapter 4, Mine Layout, and Chapter 5, Environmental Engineering.

Transportation refers to the transport of goods, products, and personnel to and from (as well as on) the minesite.

The infrastructure and transportation systems for a mine in a remote location are a real challenge and of great importance to the success of the mining venture.

27.2 Rules of Thumb

Surface Haul Roads

- Mine haulage costs at open pit mines may represent 50% of the mining cost and sometimes as much as 25% of the total costs, which include processing, marketing, and overheads. *Source: A. K. Burton*
- In general, 10% is the maximum safe sustained grade for a haul road. For particular conditions found at larger operations, it has often been determined at 8%. It is usually safe to exceed the maximum sustained grade over a short distance. *Source: USBM*
- The maximum safe grade for a haul road over a short distance is generally accepted to be 15%. It may be 12% at larger operations. *Source: Kaufman and Ault*
- The maximum safe operating speed on a downhill grade is decreased by 2 km/h for each 1-% increase in gradient. *Source: Jack de la Vergne*
- Each lane of travel should be wide enough to provide clearance left and right of the widest vehicle in use equal to half the width of the vehicle. For single lane traffic (one-way), the lane is twice the width of the design vehicle. For double lane (two-way), the width of road required is 3½ times the width of the vehicle. *Source: AASHO*
- The cross slope on straight sections of a haul road (from a central crown or right across) should be ¼ inch per foot for paved surfaces and ½ inch per foot for gravel surfaced haul roads. *Source: Kaufman and Ault*
- The cross slope on curved sections (super elevation) of a haul road should not exceed 6% on paved haulage roads, nor 8% on gravel surfaced roads. *Source: OGRA*
- A crushed rock fill safety berm on a haulage road should be at least as high as the rolling radius of the vehicle tire to be of any value. A boulder-faced berm should be of height approximately equal to the height of the tire of the haulage vehicle. *Source: Kaufman and Ault*
- The coefficient of adhesion (resistance to skidding) can be reduced to 10 -12% of its value on a dry road surface when the road is ice covered. On melting ice ("black ice"), it may as little as 5%. *Source: Caterpillar®*

Surface Shops

- Surface shops should be designed with one maintenance bay for six haul trucks having a capacity of up to 150 tons. This ratio is 4:1 for larger trucks. The shops should also include one tire bay and two lube bays. Additional maintenance bays are required for service trucks (1:20) and support equipment (1:12). *Source: Don Myntti*
 - Service shops for open pit mines should be designed with plenty of room between service bays for lay-down area. As a rule of thumb, the width of the lay-down between bays should be at least equal to the width of the box of a pit truck. *Source: Cass Atkinson*
-

Surface Railroads

- For preliminary calculations and estimates, a granular ballast depth of 24 inches may be assumed. The top half of the ballast will be crushed gravel (usually $\frac{3}{4}$ - $1\frac{1}{2}$ inches) and the bottom portion (sub-ballast) graded gravel (typically No.4 -1 inch). This depth assumes the bearing capacity of the sub-grade (native soil) is 20 psi and the maximum unit pressure under wood ties is 65 psi. Where the sub-grade capacity is known to be less than 20 psi, it may usually be assumed that the required bearing capacity will be obtained with the use of geo-textile filter fabric. *Various Sources*
- The maximum railroad gradient on which cars may be parked without brake applied is 0.25 - 0.30%. *Various Sources*
- The cross slope on straight sections of a railroad (from a central crown) should be 48:1 (2%) on top of the base and the sub-ballast. *Source: AREA*
- The shoulder of the top ballast should extend 6 inches wide of the ties, and both the shoulder and the sub-ballast should be laid back at a slope of 2:1. *Source: AREA*
- A rotary dump on a unit train will average 35 cars per hour. *Source: Hansen and Manning*
- The TE (Lbs.) for a diesel locomotive is approximately equal to 300 times its horsepower rating. *Source: John Partridge*
- The fuel efficiency of the engine in a diesel locomotive is near 30%; however, when the power required for operation of oil pumps, water pumps, governor and scavenger blower is taken into account, the efficiency at the rail is reduced to 23%. *Source: John Partridge*

Transport

- It is cheaper to ship 5,000 miles by ship than 500 miles by truck. *Source: Marc Dutil*
- The cargo bay of a Hercules aircraft is just wide enough to accommodate a Cat 966 Loader or a JDT 413 truck (drive on - drive off). *Source: Unknown*

Parking Lot

- The capacity of employee parking lots can be determined by the sum of the vehicles used by the day and afternoon shift personnel. Provisions should be made for future expansion at the outset. *Source: Donald Myntti*

Harbor Design

- A container ship with 4,000 TEU capacity requires a 43-foot draft at dockside. A container ship of 5,000 TEU capacity requires a 45-foot draft.
(20 foot container = 1 TEU, 40 foot container = 2 TEU)

Source: Engineering News Record

27.3 Tricks of the Trade

- The horizontal and vertical alignment (curvature) of a haulage road should be designed so that the vehicle operator can see ahead a distance at least equal to the stopping distance of the vehicle. *Source: Kaufman and Ault*
- Sharp curves should be avoided on a haulage road, especially near the crest of hills (not visible at night) and near the foot of a long downgrade (long stopping distance). *Source: George Totten*
- In temperate climates, road alignment should be kept to high ground as much as practical to minimize deposits of wind borne snow. *Source: Bill Wright*
- Survey stakes on the side of the roadway are marked to indicate the finished grade for sub-base, base, and surface course, each with a fixed vertical off-set (typically four feet). A convenient way to monitor road grade during construction is with a hand level held on top of a plain stick ("boning rod") that is four feet long. *Source: Grant Devine*
- Mine operators should encourage haul truck drivers to not use the same path on the travel lane so that rutting and furrowing will be minimized. *Source: Dave Assinck*
- In extremely cold weather, transport and haulage trucks may lose significant engine power due to slow fuel injection. A quick remedy is to add gasoline to the diesel fuel. *Source: Dave Assinck*

- To estimate the quantity of granular or slag ballast required for a railroad from cross-sections, use a unit weight of 100 pounds per cubic foot and allow for 20% shrinkage. *Source:* J. K. Lynch
- Smelter slag in sizes corresponding to crushed gravel normally employed makes good ballast; however, slag with a high sulfur content tends to promote dry rot in wood ties. *Source:* AREA
- Geo-textile filter fabric should be used when required to increase the bearing capacity of the sub-base but not to reduce the design thickness of the ballast. *Source:* Unknown
- A thirty-day reduced speed period should be enforced on a newly constructed railroad where the planned train velocity exceeds 30 mph. *Source:* AREA
- Curves on unit train lines are best laid out at less than 6 degrees. Sharper curves will likely need track lubricant and curves exceeding than 10 degrees should not be considered. *Source:* Hansen and Manning
- The draw bar pull of a diesel locomotive will be approximately 25% of its weight. *Source:* C. M. Magee
- The following shortcuts may be taken in the calculation of train resistance.
 - Grade resistance is 20 Lbs./ton for each one-percent gradient
 - Curve resistance is 0.8 Lb./ton for each one-degree of curvature
 - Starting resistance is 18 Lbs./ton (journal bearings on car wheels)
 - Starting resistance is 6 Lbs./ton (roller bearings on car wheels)
 - Starting resistance is doubled for extreme cold weather
 - Starting resistance is doubled for poor track conditions
 - Acceleration resistance is 100 Lbs./ton for each one-mile per hour/second
 - Air resistance may be ignored since acceleration resistance is higher

Source: John Partridge

- Mine building construction contracts should clearly define battery limits for utilities, such as water and sewer lines. Common practice is to have the builder responsible to a nominal distance from the building such as 5 feet or 1,500mm. *Source:* Eric Seraphim
- During mine construction, it is usually more reasonable to have the mine owner provide a main first-aid station and ambulance service for all the contractors than it is to expect each individual contractor to provide separate services. *Source:* Harry Foster
- Aprons installed along the perimeter of the surface shop building will improve housekeeping and facilitate the completion of running repairs that can be performed out of doors. *Source:* Donald Myntti
- Protective bollards should be placed at either side of truck doors at surface shops. *Source:* Erik Seraphim
- A good way to make a bollard is to use a 2m length of small diameter culvert. Stand the culvert vertically in a hole dug 1m deep, backfill with compacted granular material, and then fill the culvert with concrete. *Source:* Don Bruce
- Where a mine incorporates a pump to dispense gasoline, it should be located in near vicinity to the security gate office. *Source:* Donald Myntti
- To discourage pilferage, the mine's parking lot should not be laid out with parking stalls adjacent to the mine fence, but otherwise as close as practical to the main gate. *Source:* John Kostuik
- In the far North, personnel parking can be accommodated inside the gate and close to the work entrance, at least during the winter months. While this poses a small problem for security, it provides a great boost to morale for employees who do not have to walk 300 yards in foul weather. *Source:* Gerry Marshal
- To ensure reliable start-up in cold weather, fire pumps should be powered by gasoline engines. The gasoline should contain a stabilizer agent and the tank re-filled with fresh gasoline every six months. *Source:* Jack de la Vergne
- There is no system available on the market that can be relied upon for certain to protect the load cells of a truck scale from a lightning strike. A simple solution is to install welding cable to ground from over each cell location and provide slack with a free loop of the cable so that the accuracy of the scale is not affected. *Source:* Dave Assinck

27.4 Haul Roads

Poorly built mine haul roads will require more maintenance and reduce haulage truck productivity. Poorly built roads may also be responsible for a significant number of vehicle accidents on the minesite.

In the past, mine haul roads were often built to municipal or highway design standards. With the advent of huge haulage trucks, these design parameters are no longer adequate. For example, the larger haul trucks have a longer sight distance (because the driver is high off the ground), but this is insufficient to compensate for the longer stopping distances they need. To accommodate the larger trucks, mine haul roads need to be straighter, wider, and stronger than rural highways.

Road Surfacing

In warm climates, permanent haul roads are often paved with asphalt or concrete to save on tire and fuel costs, reduce maintenance, and avoid dust. In northern climates, the advantages of paving are reduced due to the requirement for sanding and salting in winter to avoid slippery travel.

The principal guidelines for good road design are to provide an adequate base (foundation) and ensure good drainage for both the surface and the base of the roadway.

Roads on Poor Soils

Design parameters for haul roads are mainly rules of thumb; however, in certain cases, engineering is required. The most difficult problems may be those concerned with assessing the requirements for roadway construction on poor soils, such as silts (frost susceptible), clays (low bearing capacity), and marls and muskegs (high compressibility). Roadways on silts and clays usually require geo-textile membranes and/or a thicker base construction. Marls and muskegs may require geo-textile membranes, special drainage, consolidation with shot rock, or even complete removal. When these “swampy” conditions occur in remote wooded areas, there is still occasional good application for “corduroy” roads built on limbed trees laid side by side across the sub-base of the road.

Curvature

Curves on a roadway may be measured in degrees of curvature or radius. (Degree of curvature is defined as the central angle subtended by a chord of length 100 feet on the arc of a circular curve.) The maximum allowable curvature may be determined by line of site; usually the critical factor is vehicle speed.

Example

Find the minimum permissible radius of curvature, R, for a gravel surfaced haulage road.

- Facts:
1. The gravel surfaced haulage road has a design speed, V, of 50-mph.
 2. The road has a corresponding minimum radial coefficient of friction, f, equal to 0.20.
 3. The super elevation, e, on the curve is maximized at 6%.

- Solution:
1. Minimum radius of curvature, $R = V^2/15(f+e) = 2,500/15(0.20 + 0.06) = 641$ feet.
 2. The corresponding degree of curvature, D, is 9 degrees obtained from the equation $D = 5729.6/R$, or interpolated from the Table 27-1.

Table 27-1 Degree and Radius of Curvature

Degree of Curvature	Radius of Curvature (feet)
4	1,432
5	1,146
6	955
7	819
8	716
9	637
10	573
11	521
12	477
14	409

Dust Suppression

On gravel haul roads, treatment for dust suppression is a significant concern. For this purpose, it is usual to apply calcium chloride (CaCl₂), either in liquid or granular form. A liquid application is usually longer lasting, but often not practical. In either case, it is best to scarify the road surface with a grader beforehand and fine-grade it afterwards. Between 1 and 2 Lbs. of CaCl₂ per square yard of road surface are required. Usually, an initial application is made at 1 Lb. of CaCl₂ per square yard, after which applications of ½ Lb. per square yard are made as needed.

Magnesium chloride (MgCl) may be employed instead of CaCl₂ at environmentally sensitive minesites.

Snow and Ice

In temperate climates, haul roads are plowed clear of snow in winter but this is often insufficient to prevent icing of the roadway. Normally, sand is applied to provide traction after plowing. The proper application of roadsalts in addition to sand facilitates plowing and enables cleaning to a bare surface.

Sand is sometimes applied only at hazardous locations such as curves, intersections, railroad crossings, and hills. Rates of 500 pounds to 2 cubic yards per mile are common. It is important to calibrate spreaders to control application rates.

The sand employed should be coarse and screened to remove stones (that break windshields). Treating sand with 2% - 4% salt (by weight) is necessary to keep it from becoming frozen and unworkable. The salt also helps to anchor the sand into the ice surface; make the sand easier to load from the stockpile, and allow it spread more evenly from mechanical spreaders.

If slag, cinders, or other abrasives are wet, they also need salt to be usable. The same amount of salt should be added as for sand. Pre-wetting sand with a liquid de-icing chemical just before spreading has proven effective in embedding the abrasive on icy pavements.

The most common (and least expensive) road salt employed is rock salt (sodium chloride NaCl), which usually comes from mined rock salt that is crushed, screened, and treated with an anti-caking agent.

Another commonly used chemical, calcium chloride (CaCl₂), comes from natural brines. It comes dry in pellets or flakes, or in solutions of various concentrations. Magnesium chloride (MgCl) is also employed.

De-icing road salts work by lowering the freezing point of water. The maximum effect is theoretically obtained with the following optimum solutions.

- A 23.3% concentration of NaCl in water freezes at -6 degrees F.
- A 29.6% concentration of CaCl₂ in water freezes at -59 degrees F.
- A 22.0% concentration of MgCl in water freezes at -22 degrees F

In practice, these roads salts are effective on haulage roads at higher temperatures than indicated above. Normally, 15-20 degrees F is considered the lower limit for NaCl (rock salt). If de-icing is necessary at lower temperatures, more salt is needed and melting will take much longer. In this case, MgCl and/or CaCl₂ may be a better choice. In extremely cold temperatures, no road salt is effective.

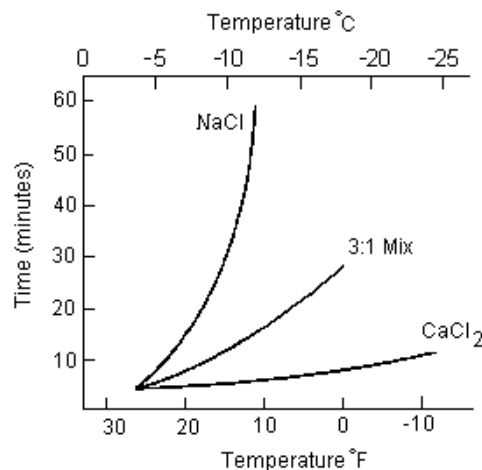

Figure 27-1 Melting Power of Road Salts

The previous graph shows the comparative time for different compounds to melt 1/8 inch (3mm) of glare ice. The graph also shows how well a mixture (three parts rock salt to one part calcium chloride) works at lower temperatures.

Time of application is the most important factor in successfully clearing snow with road salts. Early application is critical. Spreading a small amount of road salt just as a storm is starting creates slush ("brine sandwich") on the road surface. Further snowfall is not packed to the surface by traffic, which lets plows remove it efficiently.

27.5 Railways

Aside from standard railway sidings connected to main trunk railway lines, some mines employ independent unit trains to haul ore or concentrate. A unit train can be defined as a train of between 100 and 150 cars that is restricted to service between a single point of origin and a single destination. The rail line typically involves at least a mile of track laid out in a loop formation. The loop requires a spur for shunting and access to repair shops. Many unit train locomotives are electric, employing overhead trolleys. Rotary dumps are typically employed. Unit train operations lend themselves to computer simulation and automation.

Size

Unit train railways are usually constructed with standard gage of 4 feet 8½ inches (1,435mm). As with main line railroads, the gage is widened on curves over 8 degrees (to a maximum of ¾ - 1 inch). Rail size varies between 90 and 140 Lbs./yard depending on the size of locomotive employed and line speed. For example, a 50-ton locomotive with six driving wheels at a line speed of 40 mph may require rail weighing 100 Lbs./yard.

Ties

For purposes of preliminary design, ties may be assumed 7 by 10 inches, 9 feet long. Spacing for wood ties is typically 19½ inches (24 per standard rail length of 39 feet). Spacing for concrete ties may be 30 inches. Super-elevation on curves can be calculated by subtracting 3 inches from the value obtained from the equilibrium formula, $e = 0.0007DV^2$ (e = inches, D= degree of curvature, V = line speed in mph). If the super-elevation determined exceeds 6 inches, the line speed must be reduced on the curve to meet this limitation.

Drainage

The single most important characteristic of railway design is adequate drainage for the structural foundation (ballast). To achieve this in cut sections, ditching must be provided at an elevation lower than the base of the ballast. The quality, compaction, and depth of ballast are also of primary concern.

General Design

The general design principals are similar to those for the haulage roads previously described; however, as referenced in the rules of thumb, requirements for alignment, grade, and curvature are stricter for railroads than for haulage roads. Rail haulage is much less flexible than truck haulage, which is one reason that trucking is usually favored over rail haulage, even though the unit cost of cargo transport may be higher.

Example

Find the thickness of ballast, h, required for a rail line for wood ties and concrete ties.

- Facts:
1. The bearing capacity of the sub-grade, P_c , = 20 psi
 2. The maximum tie pressure, P_a , is 65 psi for wood ties.
 3. The maximum tie pressure, P_a , is 85 psi for concrete ties.

- Solution:
1. The total thickness of ballast required beneath the ties, $h = (16.8 P_a / P_c)^{0.8}$
 2. For wood ties, $h = (16.8 \times 65/20)^{0.8} = 24.5$ inches.
 3. For concrete ties, $h = (16.8 \times 85/20)^{0.8} = 30.4$ inches.

(Note that additional ballast is placed between the ties to within 2 inches of rail base.)

27.6 Land Drainage and Culverts

(For the design of ditches and culverts, please refer to Chapter 5 – Environmental Engineering.)

In cold climates, culverts may be plugged with ice in the spring. In temperate climates, plugging can be normally avoided if culverts are properly sloped and of diameter 18 inches (450mm) or greater. In permafrost regions, culverts will invariably be plugged in spring regardless of the slope or diameter.

The traditional method of thawing culverts is with steam. A faster and less costly method is by electrical thawing – the electrical installation can consist of a No. 0 insulated copper wire running through the culvert with each end secured to stakes at opposite ends. In the spring, a portable welding machine (with leads attached to each end of the wire) will thaw a hole through the ice in one to four hours (depending on the length of culvert and the capacity of the welding machine). The water flowing through the hole in the ice will then widen it without further thawing required.

27.7 Aircraft Payload Capacities

Table 27-2 shows aircraft payload capacities.

Table 27-2 Aircraft Payload Capacities

Aircraft	Name	Manufacturer	Maximum Payload ¹	Runway Required
AN-124	Condor	Antonov	330,000 Lbs.	9,850 feet
A380-100F ²	Jumbo Jet Freighter	Airbus	330,000 Lbs.	10,600 feet
C-5	Galaxy	Lockheed	240,000 Lbs.	6,000 feet
L500	Jumbo Jet	Airbus	215,000 Lbs.	9,200 feet
747	Jumbo Jet	Boeing	215,000 Lbs.	9,200 feet
C-17	McDonnell Douglas	Globemaster	200,000 Lbs.	3,000 feet
KC-135	Boeing	Strato-tanker	22,000 gals.	7,000 feet
KC-10	McDonnell Douglas	Extender	180,000 Lbs.	7,000 feet
C-130	Lockheed	Hercules	35,000 Lbs.	±3,000 feet
DC-9	DC-9	Douglas	22,750 Lbs.	5,000 feet
DC-3	DC-3	Douglas	6,000 Lbs.	3,000 feet
DH-6	Twin Otter	De Havilland	±5,500 Lbs.	860 feet
DH-3	Otter	De Havilland	±3,800 Lbs.	630 feet
DH-2	Turbo Beaver	De Havilland	2,240 Lbs.	1,000 feet
DH-2	Beaver	De Havilland	2,100 Lbs.	1,000 feet

¹Maximum capacities (ACL). For individual flights, these values may be reduced to account for fuel carried, weather conditions, airport altitude, as well as actual runway lengths.

²Delivery expected 2008

28.0 Mine Maintenance

28.1 Introduction

Performing efficient and effective mine maintenance lowers total mining costs, rather than only the costs of the Maintenance Department. The role of mine maintenance is to provide quality work efficiently with minimal disruption to the production routine.

The aim of this chapter is to describe the procedures, personnel, and equipment required to fill this role. The emphasis of the chapter is on Work Practice, including routine maintenance, preventive (and predictive) maintenance (PM), and the provision of adequate shop/warehousing facilities. The Work Practice discussed is specific to the mobile fleet in a large underground trackless mine. Because small mines need less complex systems, Chapter 28.7 provides a simplified strategy specifically for smaller mines.

An appendix (Chapter 28.8) contains data concerned with mine hoists (lubricants, tools and equipment).

Like the preceding chapters, this one includes rules of thumb and tricks of the trade. While most items are concerned with an underground fleet, some relate to other maintenance tasks and many are generic applying to maintenance in general.

Mine maintenance may be categorized into three principal divisions.

- Management and Administration
- Work Practice
- Operating Environment

Each of these three divisions is subdivided in the main text of this chapter and is dealt with in sequence.

Mine Maintenance Department efficiency is typically addressed by directing attention to the following three areas.

- One focus is on minimizing the size of the maintenance work force. The direct cost savings may not be significant; however, the indirect benefits include improved communications, more initiative, and less supervision.
- Another focus is on inventory reduction. Reducing inventory is accomplished directly by component standardization, modular components, repair kits, contract warehousing, and single-source equipment purchases. Indirectly, inventory reduction is accomplished by employing state-of-the-art diagnostic equipment to displace instinct that results in wrong parts being replaced.
- A third focus is on minimizing the size of the production equipment fleet by increasing its availability and reliability. In this case, cost savings accrue to the Production Department.

28.2 Rules of Thumb

General

- The degree of maintenance enforcement at an operating mine should be just less than the point that disruptions to operations are at a level where additional maintenance costs equal the resulting profits from production. *Source: David Chick*
 - In a trackless mine operating round the clock, there should be 0.8 journeyman mechanic or electrician on the payroll for each major unit of mobile equipment in the underground fleet. *Source: John Gilbert*
 - Emergency repairs should not exceed 15% of the maintenance workload. *Source: John Rushton*
 - LHD units at a shallow mine with ramp entry should have a utilization of 5,000 - 6,000 hours per year. *Source: Unknown*
 - Captive LHD units should have a utilization of 3,500 - 4,500 hours per year. *Source: Unknown*
 - LHD units in production service should have a useful life of at least 12,000 hours, including one rebuild at 7,500 hours. A longer life can be presumed from LHD units at the high end of the market with on-board diagnostics. *Source: John Gilbert*
 - Underground haul trucks should have a useful life of 20,000 hours; more if they are electric (trolley system). Longer life may be presumed in the light of today's improved onboard diagnostics and better management of equipment maintenance in general. *Source: John Chadwick*
-

Service

- An efficient Maintenance Department should be able to install one dollar worth of parts and materials for less than one dollar of labor cost. *Source:* John Rushton
 - A servicing accuracy of 10% is a reasonable goal. In other words, no unit of equipment should receive the 250-hour service at more than 275 hours. *Source:* Larry Widdifield
-

Infrastructure

- With ramp entry, a satellite shop is required when the mean mining depth reaches 200m below surface. A second one is required at a vertical depth of 400m. *Source:* Jack de la Vergne
 - With ramp and shaft entry, a main shop is required underground when the mean mining depth reaches 500m below surface. *Source:* Jack de la Vergne
 - A main shop facility underground should have the capacity to handle 10% of the underground fleet. *Source:* Keith Vaananen
 - Service shops for open pit mines should be designed with plenty of room between service bays for lay-down area. As a rule of thumb, the width of the lay-down between bays should be at least equal to the width of the box of a pit truck. *Source:* Cass Atkinson
 - Surface shops should be designed with one maintenance bay for six haul trucks having a capacity of up to 150 tons. This ratio is 4:1 for larger trucks. The shops should also include one tire bay and two lube bays. Additional maintenance bays are required for service trucks (1:20) and support equipment (1:12). *Source:* Don Myntii
-

28.3 Tricks of the Trade

- Good housekeeping in shop facilities is absolutely crucial because effective safety and maintenance programs begin with clean shops. *Source:* Don Myntii
- Whenever figures for equipment availability are considered, they must be accompanied by an explicit definition, otherwise they are worthless. *Source:* Steve Harapiak
- A guaranteed availability contract with an equipment supplier may be an invitation to replace parts before necessary and pay original equipment manufacturer (OEM) prices for every one. *Source:* Jack de la Vergne
- To estimate current operating costs for a particular piece of mobile equipment, it is convenient to use monthly charges accumulated over a one-year period. They are kept current by adding the latest month and deleting the 13th month. *Source:* Robert Winkle
- Checklists developed for routine maintenance intervals typically require a very large number of components be inspected, many quite needlessly. The lists should be audited to identify and eliminate trivial pursuit. *Source:* Iain Le May
- Inventory can be cut and downtime reduced by providing pre-packaged assortments of springs, O-rings, snap rings, machine screws, springs, and cotter pins. *Source:* Roger Bryar
- Inventory can be cut and downtime reduced by providing kits (brake, carburetor, valve, O-ring, V-belt, and gasket). *Source:* Bob Dengler
- Paperwork can be saved and downtime reduced with the implementation of "free-issue" policy where items such as nuts, bolts, and washers are stored in open receptacles outside the warehouse wicket. *Source:* Earl 'High Pockets' Farnham
- Standardization should include both hydraulic fittings and grease fittings. *Source:* Dave Assinck
- Grease nipples that are difficult to access may be moved to a more convenient location with a pipe extension. *Source:* Largo Albert
- The permissible wear on a disc brake (for example, 1.3-mm) can be found stamped on the disc near the flange bolt holes. *Source:* Gerold Heinz
- Brake squeal and creep are caused by glazing of a brake pad surface, which can be quickly corrected with one shot with an out-of-service dry chemical fire extinguisher. *Source:* Gerold Heinz
- Mechanics should be instructed that when working on a unit of mobile equipment for any reason, the brakes must be checked before releasing the equipment to the operator. *Source:* Gerold Heinz
- An ultra-sonic bearing cleaner performs well on anti-friction bearings up to 12 inches (300mm) diameter. *Source:* Gerard O'Halloran

- Electricians, not mechanics, should grease the bearings on electric motors. Over-lubrication may not be harmful to mechanical equipment, but it is to electric motors. Source: Largo Albert
- A tradesman with rings on his fingers should not be employed in the Maintenance Department. A wedding ring may be worn in the ear to satisfy a vow or promise. Source: Dave Assinck
- When transporting diesel powered equipment on the highway, the exhaust stack should point to the rear (or be sealed with duct tape), otherwise the turbocharger will be spun in reverse and damaged. Source: Dave Assinck
- Shop facilities should be well lit. The walls and back of underground shops should be routinely whitewashed to avoid becoming darkened with flat textured exhaust soot. Source: John Gilbert
- A small library of equipment operating and spare parts manuals is required in main shop facilities. The library should also include general catalogues for equipment, tools, and supplies, as well as appropriate trade journals. Source: John Gilbert
- Desktop computers in the surface and underground shops should be equipped to display electronic parts catalogues on disk (or CD-Rom) provided by the OEM. Source: John Gilbert
- A plastic wrap over the keyboard of a desktop PC in the shop will protect it from greasy fingers. Source: Red Blanchette
- Concrete aprons installed along the perimeter of a surface shop building will improve housekeeping and facilitate the completion of running repairs that can be performed out of doors. Source: Donald Myntti

28.4 Management and Administration

Management and Administration is divided into the following four categories.

- Planning and control
- Statistics
- Training
- ISO Accreditation
- Planning and Control

A centralized planning and control system is necessary to ensure the planned work of the Maintenance Department will be coordinated with the needs of the mine operators. Without a continuous review, no assurance can be given that work will be organized or completed efficiently. For the system to work effectively, it is necessary to have a dedicated Planning Control Department.

The Planning Control Department has the following primary responsibilities.

- Planning routine maintenance.
- Planning PM.
- Coordinating maintenance and repairs.
- Scheduling maintenance and repairs.
- Work loading (allocation of personnel).
- Converting field data to the mine accounting system.

Staff

If the Planning Control Department is dedicated to an equipment fleet, the staff could consist of the following people.

- Supervisor (1) – prepares weekly and monthly plan and reports to Maintenance Superintendent
- Mechanical Planner (2) – prepares Daily Work Schedule (DWS)
- Electrical Planner (1) – prepares DWS
- PM Technician (1) – responsible for PM and inventory
- Technician/Clerk (1) – responsible for inventory
- Filing Clerk (1) – records
- Receptionist/Typist (1)
- Expediter (1)
- Translator (1) – (if required at a foreign location)

Track Equipment Repairs and Calculate Statistical Data

Two Planning Control Department tasks are to track equipment repairs and calculate statistical data, such as availability and utilization. The department issues a monthly report, including availability, utilization, and detailed costs. Each calendar year, the Planning Department issues an annual report summarizing the monthly reports and establishing a proposed schedule for mobile equipment replacement (new purchases). The staff's primary task is to coordinate input for routine maintenance, routine repairs, rebuilds, etc. Following are the principal implements used to complete this function.

- Numerical identification of equipment
- Equipment roster
- Work order system
- DWS
- Weekly plan
- Monthly report
- Annual report
- Work standards (performance standards)
- Job descriptions

Numerical Identification of Equipment

An identifying number is applied to all equipment by the mine. It is not the serial number. For an equipment fleet, the numbering system starts with No.1 for the first machine purchased and proceeds in chronological order to the latest acquisition.

Equipment Roster (Master List)

The equipment roster is a list of equipment that includes manufacturer, model, date of purchase, location, status, and latest month end hour-meter reading. The list also includes equipment sent away for rebuild, but does not include equipment in the bone yard.

Work Order

A work order (or job ticket) refers to a specific task to be completed on a particular piece of equipment. The Planning and Control Department may initiate a work order for routine maintenance while the Operations Department may initiate a work order for repairs.

Once approved, work orders are assimilated into a comprehensive Weekly Plan that is implemented day by day by means of the DWS. The work order and DWS provide the work requested, work instructions, and a record of the work performed.

Daily Work Schedule

The DWS consists of the names and crafts of the journeymen in a particular area of maintenance. The respective columns identify the equipment number, work order number; description, priority of the work, and an estimate of the man-hours to be expended. Subsequent columns list the working hours of the shift and a space for comments.

The DWS system lends itself to computerization, but can be performed manually. Computerization facilitates communications, changes, archiving, and transfers.

Weekly Plan

The weekly plan consists of a list of all mobile equipment scheduled for maintenance during the coming week. The type of maintenance and the standard schedule for each item of work is listed. An allowance is made for emergency repairs. The weekly plan is prepared in advance and provided to the Operations Department, as well as "posted" for planning/information purposes.

Work Standards

Work standards are established by the mine for routine chores and include a list of instructions and expected performance (e.g., eight man-hours for the "100 hour" routine maintenance service). The number of jobs performed in a period of time may be useful; however, the number of man-hours spent on each job determines performance. When work standards are first established, they should be audited to ensure that they are comprehensive and accurate. Loose estimates of man-hours or incomplete instructions must be corrected. The work standards may be expanded to include a bill of materials and special tools required for each job. The standards provide benchmarks for and aid productivity. An example of a work standard appears in the appendix (Chapter 28.8) along with a list of standard abbreviations useful for computerization.

Job Descriptions

Job descriptions provide working procedures and job classification data. Job description use is not confined to tradesmen and apprentices, but useful for all levels of supervision. Although job descriptions appear to be a logical asset, this management tool is the subject of controversy. Some question whether job descriptions should be employed because of unforeseen problems that may arise. For example, specific job descriptions can impede implementation of cross-training and multi-tasking programs for tradesmen and invite jurisdictional disputes. Once published, job descriptions can be difficult to delete.

Statistics

- As W. Edwards Deming said, “*If you can’t measure it, you can’t manage it.*” In mine maintenance, efficiency and performance are measured with statistics. Following are the principal statistics employed.
- Equipment availability
- Equipment utilization
- Mine efficiency
- Equipment life cycle
-
- Manpower utilization
- Work index
- Backlog

Equipment Availability

Equipment availability is the original statistic employed to evaluate equipment performance. Unfortunately, there is not yet an international standard definition of the meaning of this basic measurement. As a result, it is difficult to establish inter-mine benchmark values for fundamental measures of reliability of equipment and maintenance programs. Nevertheless, the measurement is a vital statistic for an individual mine.

Customarily, availability is calculated as the percentage of time the piece of equipment is available to work compared with the total time available. Whenever availability is reported, a definition must accompany the figure, since there are numerous determinations that can be made. A gross time available of seven hours per eight-hour shift (21 hours per mine operating day) may be acceptable, as long as it is clearly defined.

Following is the most commonly accepted formula for availability, A.

$$A = (T_t - T_d)/T_t$$

Where

T_t = total time available in the period of measurement

T_d = downtime due to routine maintenance, repairs and lack of replacement parts

It is acceptable (and recommended by at least one authority) that the time a unit of equipment is down for major repairs, overhaul, or rebuild is subtracted from the total available time (T_t) to calculate the figure for availability.

Equipment Utilization

Equipment utilization is another key statistic employed to evaluate mobile equipment performance. Utilization may be expressed in three different ways.

- Hours of service per year
- Tons of ore handled per year
- Percentage of time of productive work compared with the time available to work

Of these three definitions, the first may be the most reliable because it is an absolute value that requires no calculations other than subtraction of hour-meter readings. There is no confusion as to the exact meaning and the resulting figures are not suspect; however, it is acceptable to report three separate values for utilization (for each of the three definitions), if desired.

A utilization of 3,500-4,500 hours per year is typical for a captive unit of underground mobile equipment employed six or seven days per week on a three-shifts per day basis. Higher figures are obtained at shallow mines that can have a “hot seat” operator change on surface.

Mine Efficiency

Mine efficiency is a relatively new term that refers to one aspect of equipment utilization previously described (percentage of time of productive work compared with the total time available to work).

When combined with availability, mine efficiency provides a convenient gauge for calculating the production potential of a unit of equipment. Measuring mine efficiency presents a problem. If a unit of equipment were fitted with two hour-meters, one standard and one set not to record engine idle, efficiency could be measured by the difference in readings taken at prescribed intervals. (Once started, production equipment is usually kept running throughout the shift.)

Mine efficiency for an open pit may be 85%, but in an underground mine it is only to 60-75% due to complex work access, difficult communication, and shorter muck cycles.

Equipment Life Cycle

The equipment life cycle (useful life of equipment) is a vital statistic that recently has received more attention. For example, the workhorses of an underground fleet are the LHD units, which typically have the shortest life span and receive the most attention. The strength and efficiency of LHD units will quickly deteriorate after 5,000 hours of service if they are not well maintained. A reasonable goal (with a good maintenance program) was once to expect 7,500 hours of reliable service before a major rebuild and a total production life of at least 12,000 hours. Modern LHD units equipped with electronic ignition and on-board diagnostic devices can expect much longer life. After production life, a unit of equipment may be scrapped or customized and put on "light duty" as a utility vehicle.

Manpower Utilization

Manpower utilization (direct utilization of tradesmen) is another one of the fundamental statistics employed to evaluate the effectiveness of mine maintenance. It is often defined as the number of man-hours in a shift that a journeyman mechanic or electrician is actually working on a piece of equipment. The time may average 3 - 3½ hours per shift, which does not include time lost due to travel, waiting (for parts, tools, and equipment), instructions, searching data from manuals, safety huddles, completing forms, timesheets, logs, etc. A low value for this statistic may indicate lack of proper controls, poor organization, scarcity of tools and equipment, and/or inefficient parts and materials delivery to the working areas.

Work Index

Work index is a means to measure sector or overall performance of the Maintenance Department. It is defined as the comparison of labor cost with total cost of maintenance. Work index may be expressed as a ratio, but usually is expressed as a percentage. A par value for the WI is often near 50% and a typical goal is 40%.

Backlog

Backlog is another statistic used to measure performance. The measure of backlog is the estimated number of man-hours required to complete the maintenance and repair work in hand. Historically, it was used to determine when manpower needed to be increased. Backlog can also be an indicator of improvement obtained from a static work force.

Training

For many years, it has been recognized that effective training, education, and development of the mine workforce can only be accomplished with a discrete, formal program requiring specialized staff and an allocated budget.

Dedicated space must be provided and equipped as a training facility (the space can double for safety training and other functions). The facility should be equipped with equipment elements, overhead projectors, flip charts, video-cassette recorder (VCR), and personal computer (PC) with a video data projector. For items of sophistication, such as hydraulic drills or remote LHD operating devices, the manufacturer can usually provide instructors and teaching aids for the particular application. Another valuable asset is a library of video cassettes or compact disc – rom (CD-R) containing training lectures and visual aids (normally obtained from relevant equipment suppliers).

Any training program should be periodically audited for effectiveness to reveal issues requiring attention. An example is finding that there is a deficiency in teaching aids – a problem that is simply corrected. Another example would be finding that an instructor is knowledgeable but not skilled in the art of teaching.

Some training programs are set up to have equipment manufacturer's representatives on site up to three months during introduction of new equipment. In these cases, the representatives often turn into specialized workers and lead hands instead of completing dedicated training programs. This subversion of effort is typical of what often happens when informal or ad hoc training programs are implemented, particularly at remote locations or in developing countries.

A training system is not complete without educating maintenance managers and supervisors. A typical first step is a one-week course on PM.

For supervisors, attendance in seminars, conferences, and conventions is a valuable training adjunct, especially if tours of mining facilities in the area are on the post-agenda. Alternatively, independent arrangements can be made for key people to visit with personnel and facilities at comparable mines and to invite reciprocation.

Case History

One large mine in South Africa provided a PM course to 94 maintenance foremen and supervisors. These men scored an average of 18% on a pre-test and 88% on a comparable post-test, for a gain of 70%!

ISO Accreditation

The Mine Maintenance Department is not selling services to the public; it is providing services to the mine operators. At some mines, the operator is considered to be the client as part of the implementation and accreditation of ISO 9000. The logic may be arguable, but the necessary procedures for implementation are beneficial in improving the mine maintenance program. At smaller mines and most mines in developing countries, the effort required to receive accreditation is simply not practical.

28.5 Work Practice

The following components of Work Practice are specific to maintaining the mobile equipment fleet in an underground mine.

- Routine maintenance
- Preventive maintenance (PM)
- Unscheduled repairs
- Shop facilities
- Spare parts and supply inventory lists
-

Routine Maintenance

Routine maintenance (regularly scheduled service) is typically carried out at prescribed intervals as follows.

- Vehicle check at start of shift (by operator)
- 100 hours (wash, grease, and inspect)
- 250 hours (service)
- 500 hours (service)
- 750 hours (service)
- Monthly check (irrespective of machine hours)

Original Equipment Manufacturer Routine Maintenance Intervals

These are a simplification of the routine maintenance intervals typically specified in most OEM operating manuals (following).

- Vehicle check at start of shift (by operator)
- 50 hours (60 hours in West European-built equipment manuals)
- 100 hours (125 hours in West European-built equipment manuals)
- 250 hours
- 500 hours (600 hours in East European-built equipment manuals)
- 1,000 hours
- 2,000 hours
- Annual

Changing Engine Oil

One elementary maintenance exercise is changing engine (crankcase) oil. In an underground mine, oil changes are normally performed on LHD units at each 250 hours of service. The interval may have to be reduced in certain circumstances, particularly in developing countries, such as high sulfur content in the fuel. It is normally specified (and is the law in some jurisdictions) that diesel fuels for use underground have sulfur content of 0.5% or less. Higher sulfur content will often result in SO₂ concentrations in the exhaust that exceed the accepted TLV under normal ventilation conditions.

High sulfur content also has a deleterious effect in the engine because it breaks down crankcase oil. Some equipment manuals state that the oil change interval should be halved when the sulfur content exceeds 0.5%. Where surface operations suffer high sulfur content in the fuel, it is recommended that oil changes for rubber-tired loaders be made according to the following chart (the intervals for haul trucks are longer).

Table 28-1 Engine Oil Change Intervals

Engine Oil Change Intervals	
Fuel Sulfur Content	Oil and Filter Change Interval
0.0% to 0.4%	250 service hours
0.4% to 1.0%	125 service hours
1.0% to 1.5%	60 service hours

Fuel Injectors

Another problem with fuel can be that it is not adequately de-waxed at the refinery causing gumming of the fuel injectors. Injectors are expensive and should last for approximately 6,000 hours. Change-out of injectors is an intricate operation that can cause damage if not completed with proper tools and diligence. A temporary remedy is to dose the fuel with a petroleum distillate, such as naphtha gas; however, efforts should then be directed towards obtaining a better quality fuel. The advantages of cleaner exhaust and a return to the normal oil change interval should offset the increase in cost of proper fuel.

Regular diesel fuel sold today in North America by major oil companies is extremely low in paraffin (and sulfur) content. As a result, some operators add automatic transmission fluid (ATF) to the diesel fuel to improve engine lubrication.

Fuel Tank Bleeding

One often forgotten routine maintenance item is bleeding the fuel tanks of water and sediment. The amount of water that can condense inside a fuel tank is significant. Mobile equipment that works on surface or routinely travels to surface from the underground should have fuel tanks topped up when half full, especially in temperate climates. Adding methyl alcohol to the fuel is justified in extremely cold weather, but otherwise methyl alcohol prevents natural separation of the water (that could otherwise be bled off) and reduces the caloric value of the fuel.

Greasing Equipment

Another elementary maintenance exercise is greasing equipment. Common problems include missing some of the many grease points and failing to replace damaged nipples. Broken nipples can be very difficult to remove without proper tools and often they are located in areas that are not easy to access. In such cases, it is not uncommon for a mechanic to leave a problem nipple "for the next guy." Grease nipples come in a variety of sizes and configurations – it is beneficial to standardize the fittings on the total fleet. In cases of difficult access, pipe extensions can be installed to move the grease nipple to a convenient location.

Hydraulics

The key to avoiding problems with hydraulics is preventing contamination of the hydraulic oil. High-pressure hydraulic valves have narrow clearances that can easily become blocked with a single particle of sediment. Oil should not be put into a machine except through a finely filtered funnel.

Hydraulic fittings and hoses should be standardized for the whole fleet making it simpler to crimp replacement hoses on-site. Hydraulic tanks should be kept full to help prevent condensation.

Preventive Maintenance

More than one definition exists for PM. To some, it includes all the routine maintenance items later identified in this chapter. A more specific definition includes those items of routine inspection and maintenance that are prognostic. In this definition, PM also includes additional specific inspections and measurements that predict imminent or future problems, so that change-out or repairs can be accomplished before failure of the component while operating. This specific definition is now typically referred to as "preventive and predictive maintenance" (PPM). This chapter addresses PPM; however, it is identified simply as PM rather than PPM.

Separate Discipline

The PM planning function should be organized as a separate discipline at the mine. The person in charge of the PM program is the PM Technician, reporting directly to the Supervisor of the Planning and Control Department.

Preventive Maintenance Technician

The PM Technician is responsible to separately record the results of all PM work at the various routine maintenance intervals, and to implement/record those tests and measurements not specified for routine maintenance, such as random testing of spent engine oil samples. From the results of the measurements and tests, the PM Technician can recommend early repair or change-out of components for approval by the supervisor, implementation by the planners, and execution by maintenance personnel.

Risk-based Assessment

Once a PM system is developed and running satisfactorily, it may be upgraded to include a formal risk-based assessment program. In a risk-based system, the seriousness of each defect is considered and a “safe operating life” is estimated before it is necessary to repair or replace the component (or allow failure to occur). More recently, it has been reported that a “safe operating life” cannot be predicted with statistical confidence for some equipment components.

Inventory Control

The PM program will fail if there is an inadequate supply of spare parts and components in inventory for the mobile equipment fleet. The PM Technician with the assistance of a technician/clerk should be responsible for inventory control of mobile equipment parts and components. The inventory control function includes spare parts and stock item level monitoring, re-orders, and disposal of obsolete items. The PM Technician coordinates efforts with the Purchasing Department and the maintenance planners.

Additional Roles

The duties of an expediter are to locate particular spare parts as well as to provide face-to-face communications and delivery service between the planning office and the underground. The roles of a filing clerk, receptionist/typist and translator are self-explanatory and the services include assistance with the PM program.

Table 28-2 lists typical requirements for PM measurements and tests on the mobile equipment fleet.

Table 28-2 Measurements and Tests for Mobile Equipment Preventive Maintenance

• Testing of spent crankcase engine oil ¹	• Measurement of play in pins and bushings
• Testing of service and parking brakes	• Measurement of play and wear of drive belts
• Measurement and adjustment of play in brake linkage	• Measurement of wear in bucket lips
• Measurement of wear on the brake discs	• Measurement of backlash in front and rear differentials
• Measurement of lubricant, radiator, battery and brake fluid levels	• Check fire extinguisher device for full charge (weigh charge)
• Measurement of torque on engine mount bolts	• Check for fatigue cracks in operating components
• Measurement of torque on transmission mount bolts	• Check for leaks in water, fuel, and oil lines
• Measurement of torque on drive-line bolts	• Check seal in air bowl (pre-cleaner) of air filter device
• Measurement of torque on wheel nuts	• Check hydraulic line suction filter for damage
• Measurement of air pressure in tires	• Check for leaks or damage to exhaust manifold, muffler and tail pipes
• Measurement of tire wear	• Check exhaust for excess smoke or particulates
• Measurement of engine crankcase pressure	• Check wheel chocks are not missing
• Measurement of pressure to release pilot system relief valve	• Record engine and hydraulic oil temperatures when operating.
• Measurement of steering system pressure	

¹ Sent to the OEM (or independent laboratory) for analysis to specify the exact oil change interval required and provide predictive and preventive information on engine life

Unscheduled Repairs

Requests for repairs can result from vehicle start-up inspection, routine maintenance inspection, PM analysis, diagnosis while operating, damage while operating, or breakdown while operating. Some requests may be prioritized and scheduled, but others require immediate attention (unscheduled repair, also called emergency repair). Accommodation for these is made in the Weekly Plan by allocating a significant block of man-hours for emergency repair (perhaps 25% of the man-hours available).

Operations supervisors have a role in directing maintenance efforts for emergency repairs. At some mines, certain key maintenance personnel take field instructions directly from the appropriate mine operator. The maintenance personnel continue reporting to the Maintenance Department for administrative aspects (time sheets, shift rotation, etc.). Those opposing its implementation refer to this procedure as "fragmentation."

Shop Facilities

A surface shop facility is best for a new trackless underground mine served by ramp access from surface; however, as the mine workings progress to deeper horizons, the surface shop facility eventually becomes obsolete. Because a drill jumbo is the most difficult piece of equipment to drive to surface, the mine eventually begins to service drill jumbos in a small underground shop facility. Subsequently, it becomes necessary to service LHD units underground at which time a major underground shop is constructed and the "jumbo" shop becomes a satellite facility suitable for fuelling and lubricating equipment. A main shop facility underground represents a major investment for the mine and the location and design are the subject of detailed consideration.

Underground Location

Following are some of the criteria that must be considered when deciding on the location of the underground shop facility.

- The facility should be as close as practical to the "center of mass" of the proposed workings over the balance of the mine life.
- The facility should have convenient personnel access from surface.
- The facility should be located adjacent to the exhaust air stream.

Items two and three may be in conflict. Because the latter is considered mandatory (for reasons of fire safety), typically the shops are located near the orebody as opposed to being near the main shaft access. In most cases, "near the orebody" also means near the internal ramp (which is desirable).

Another requirement is that the facilities be located in an area of good ground. The mine's Rock Mechanics Department should be engaged to determine the exact location and orientation. If poor ground conditions are unavoidable, the shops must be designed with narrow widths.

In some mine locations, restrictive statutory requirements may apply to an underground shop facility, such as, "The welding bay must be located independent from the main shop facility."

Detail Design

The first step in the detail design of a major underground shop facility is to itemize the maintenance functions in detail. An example of the maintenance function for a typical underground shop facility is found in Table 28-3.

Table 28-3 Maintenance Functions of Main Underground Shops

<ul style="list-style-type: none"> • High-pressure detergent washing (or steam cleaning). • 250-hour and 500-hour servicing. • 1,000-hour, 2,000-hour, and annual routine maintenance. • Tire rotation and replacement. • Bent cylinder piston rod replacement. • Replacement of worn cylinder pins and bushings. • Bucket lip replacement and hard facing. • Engine and transmission diagnostics. • Transmission change-out. • Engine change-out. • Wire harness repairs and replacement. • Headlight and tail light change-out. • Wheel bearing replacement. • Replacement of worn hydraulic hose and bent fittings. • Removal of damaged or defective grease fittings and replacement. • Bent jumbo boom change-out. • Replacement of bent drive shafts and damaged universals. • Replacement of brake actuators. • Replacement of tire valve stems, wheel nuts and studs. • Replacement of main hydraulic valve assembly. 	<ul style="list-style-type: none"> • Replacement of water and steering pumps. • Regular dumping of air filter bowl and fluttering of air filters. • Cleaning and change-out of air filters. • Change-out of pellets in oxy-catalyst scrubber. • Re-calibration of brake discs. • Replacement of worn center hinge pin and bushing. • Replacement of planetary wheel end drives. • Blowing out fuel lines and brake lines. • Replacement of fuel lines and brake lines. • Change-out of water pump and fuel pump. • Brazing of oil radiator (cooler) leaks. • Replacement of leaking seals and blown 'O' rings. • Battery terminal scraping, greasing, and battery diagnostics. • Battery replacement. • Replacement of lost skid plates. • Replacement of cracked, worn, or stretched drive belts. • Replacement of frayed hydraulic control cables. • Replacement of worn out seat belts and operators seat. • Taking test samples of spent engine oil. • Miscellaneous minor repairs and replacements.
---	--

Satellite Shop

A satellite shop is normally used for shift services, such as refueling, greasing, topping up lubricants, tire inflation, etc. The requirement for satellite shops should be reviewed periodically. A second satellite shop may be required immediately or in the distant future.

Capacity

The main underground shops should have a nominal capacity to handle at least 10% of the underground fleet in repair simultaneously.

Office

The center of the operations should be an office situated with the main work areas in view.

Component Areas

The principal component areas for a typical underground shop are shown in Table 28-4.

Table 28-4 Component Areas – Main Underground Shop

<ul style="list-style-type: none"> • Parking area • Cleaning bay • Welding bay • Machine shop • Service bays • Repair bays • Lay down areas 	<ul style="list-style-type: none"> • Parts and materials storage warehouse • Tool crib • Tire storage and handling facility • Lube storage area • Hydraulic hose storage and crimping area • Office/lunch room area
--	---

Stationary and Portable Equipment

Main underground shops are typically equipped with the stationary and portable equipment shown in Table 28-5.

Table 28-5 Stationary and Portable Equipment

<ul style="list-style-type: none"> • 10-Lb. portable ABC fire extinguishers (6) • Mobile Fire Extinguisher (airport style) or Foam Generator • Wall mount first aid kits and eyewash station. • 10-15 ton capacity overhead crane • Portable one ton capacity jib crane • Chain block, 5 ton for repair bays (2) • Come-along, ½ and ¾ ton (2) • Oxygen-acetylene cart (1) • Hydraulic jack, 10 ton • Hydraulic jack, 20 ton (low profile) • 400-Ampere capacity AC/DC welder • Electrode oven, bench size • Soldering gun, complete with (c/w) 50/50 solder assortment and flux • Pedestal mounted magnetic drill press • 6 and 8-inch vise (1 each) • Anvil • Bench grinder with cut-off and grinding wheel c/w dressing tool • Bench lathe • Tripod mounted, yoke and chain pipe vise • 100-ton hydraulic press frame (jack press) for bushings • Portable grinder (pneumatic) (2) • Portable chipper (pneumatic) c/w spare moils • 3/8-inch portable drill (electric) 	<ul style="list-style-type: none"> • ½-inch portable drill (pneumatic) • Set of brake cylinder honers (internal and external) • ½-inch drive pneumatic impact wrench • ¾-inch drive pneumatic impact wrench (4) • ½-inch drive torque wrench • Pneumatic operated grease gun with flex hose end • Engine cylinder compression testing device • Set of hydraulic jacks • 10 Ampere, 6/12-volt battery charger (1) • Battery voltage tester • Battery liquid tester (SG of fluid) • Hand held volt-ohm meter • DC power supply unit, 0- 48 volts • Hand held ammeter • Milli-ammeter, 4-20 milli-ampereres (for LHD remote controls) • Ignition timer (diesel) • Portable suction sand blaster c/w hose, nozzles and protection gear • Pressure gauge, 60 bar, c/w hose and custom connectors • Pressure gauge, 250 bar, c/w hose and custom connectors • Desktop computer to display electronic parts catalogues • Safety basket for pressurizing tires
--	---

The underground shops should be equipped with the hand tools, stock items, furnishings, and sundries shown in Tables 28-6, 28-7, and 28-8.

Table 28-6 Stock Items

<ul style="list-style-type: none"> • Selected inventory of mobile equipment spare parts (in underground warehouse) • Assortment of “free-issue” items (e.g. coarse thread machine bolts, nuts and washers in open boxes outside warehouse – no paperwork required when taken). • Assortment of emery and wire cloth • Assortment of machinist's bar stock • Assortment of springs • Assortment of brass shim stock • Assortment of cotter pins • Assortment of snap rings • Assortment of machine screws • Assortment of valve stems and key caps (for tires) • Assortment of all-threaded rod (coarse thread) • Cardstock and tag assortment – for lockouts, etc. • Stock of impact wrench sockets (metric and imperial) • Assortment of “Tyrap” plastic wraps (to bundle hydraulic hoses) • Drill index 2mm to 12mm x 1mm • Drill index 1/16 inch to ½ inch x 1/64 inch 	<ul style="list-style-type: none"> • Gasket material assortment and cutting knife • Cylinder packing material assortment • V-belt (drive belt) fabrication kit and assortment of belting sizes • V-belt (drive belt) dressing compound • ‘O’ ring assortment • ‘O’ ring fabrication kit • Brake repair kits • Grease fitting assortment • Assortment of ductile copper tubing • Assortment of plastic pails c/w handles • Roll of automotive wire • Roll of mechanic's wire • Roll of haywire • Roll of 4/0 welding cable • Welder's soapstone (1 case) • Stock of clear (“throw-away”) and colored lenses for welder's helmet
---	--

Table 28-7 Furnishings and Sundry Items for Underground Shops

<ul style="list-style-type: none"> • Metal work bench (5) • Metal saw horses (2) • Welders helmet • Welding screen • Oxy-acetylene stand and cart • Cutting goggles (2 pr) c/w spare lenses • Strikers (2) and spare flints • Cutting tips, one each of Nos. 1, 2, 3, 4, 5, 7, 9 • Brazing tips, one each of Nos. 1, 2, 5, 7, 9 • Rosebud heating tip • Set of tip cleaners (reamers) • "Stinger" (welding electrode holder) (2) • Welding apron and poncho (for overhead welding) • Assortment of welding rod (7018, 6011, cast iron, stainless, bronze, arc air) • Portable rod holder container (2) • Set of battery booster cables (2) • Trouble lights with 50-foot cord (3) • Floor creepers (3) • Assortment of screened funnels • Set of chain slings with barrel hooks (1) • Barrel spouts (3) • Barrel faucets (4) • Rough duty trouble lights (2) 	<ul style="list-style-type: none"> • Snake flashlight (1) • Plastic "redibins" (50) (for storage) • Work order storage rack • Bookcase for operating and spare parts manuals • Tilt and tow fireproof trash containers (4) • Assortment of squeeze bottle and oiler cans • Penetrating oil and/or WD40 • "Loctite[®]" (250 ml): 271, 277, 242, 504 • Dye penetrating flaw detector kit • Tote trays for hand tools (3) • Canvas tote bags for hand tools (12) • Set of pegboards complete with hooks and fixtures • Stable brooms (2) • Mops complete with wringer • 10 feet by 5/8-inch choker slings (2) • 10 feet by 3/4-inch choker slings (2) • Carboy of distilled water for batteries • Hand cleaner dispenser and stock of mechanic's hand cleaner • Paper towel dispenser and rolls of paper towels • Boxes of clean rags • White or black board and notice board • Assorted "office" equipment – desk, telephone, PC, etc.
---	---

Table 28-8 Hand Tools

<ul style="list-style-type: none"> • Standard journeyman mechanics tool box assembly of tools (5+) • Standard journeyman electricians tool box assembly of tools (2+) • Set of easy-outs (broken-off bolt extractor) • Machinists tap and die set (metric and imperial) • Pipe thread, die and pipe cutter set (for small pipe diameters) • 1-inch drive Johnson power bar and large end socket set • Filter wrench (2) • Set of snap ring pliers (2) • Set of giant Allan wrenches (metric and imperial) • Hand held grease gun with flex hose end (2) • Tube cutter, flaring tool and bender set • Oxygen-acetylene cutting assemblies complete with gauges (2) • Welder's chipping hammer (2) • Tire valve tool kit, complete with stem re-threader, core tightener/remover, stem tool complete with chain to pull core through rim. • Compressed air tool and fittings kit complete with blowgun • Dropped nut-retrieving magnet 	<ul style="list-style-type: none"> • Magnifying glass (loupe) • Machinists square (metric/imperial) • Bead breaker pry bar • Set of long pinch bars and levers • Assortment of wire brushes • Assortment of wheel wire brushes to fit portable grinder • Assortment of circular cut-off disks to fit portable grinder • 24-inch channel lock adjustable wrenches (2) • 18-inch adjustable spanner wrenches (Westcott®) • 24-inch adjustable spanner wrench (Westcott®) • 24-inch adjustable pipe wrench • 36-inch adjustable pipe wrench • 2 Lb. sledge hammer (6) • 1.5 Lb. ball peen hammer • 10 Lb. double jack sledge • 12 oz. rubber mallet (2) • Bearing puller tool sets (2) • Straight-line micrometer • Set of feeler gauges (2) • Assortment of 'C' clamps
--	--

28.6 Operating Environment

In the past, the Maintenance Department had little to do with the operating environment, but this has changed. Implicit in an optimized maintenance system is dialogue between operations and maintenance personnel that cuts both ways.

Operating Environment may be subdivided as follows.

- Equipment operator qualification
- Vehicle start-up check
- On-board diagnostic and prognostic devices
- Haulage route design¹
- Haulage route maintenance¹
- Dust control¹

¹ These items are discussed in other chapters of this handbook.

Equipment Operator Qualification

Inexperienced and careless vehicle operators (and poorly maintained haulage routes) will destroy the best fleet maintenance program. For this reason, training and qualification programs are an important supplement to an efficient maintenance system.

Vehicle Start-up Check

At the beginning of the shift, the operator performs a vehicle check and completes a card. The checklist on the card is reproduced from the one found in the operator's manual. Some checklists are extensive, but all include checking the levels of engine oil, transmission oil, and hydraulic oil. The lists also include checking each brake system. Most require emptying the air cleaner dust cup. While it is the vehicle operator that completes this check, it is generally considered a routine maintenance item.

On-board Diagnostic and Prognostic Devices

Modern LHD units equipped with on-board diagnostic and prognostic devices can expect much longer life. One modern underground mine reports that they have achieved 20,000 hours of useful life on their LHD units without major rebuild.

28.7 Maintenance for Small Mines

Most large mines already employ sophisticated procedures such as those discussed in the body of this chapter. Because small mines necessitate less complex systems, this chapter specifically discusses a strategy for small mine maintenance.

Small mines have all the various types of equipment that large mines have – with smaller capacity and less duplication. The problem is that there are fewer resources available for maintenance. The typical result is that maintenance costs get out of hand at small operations. Even worse, high cost elements may long remain undetected because the system is inadequate to identify problem areas.

For the small mine to become efficient, it is necessary to optimize key elements of the management and administration components of the Maintenance Department. This may necessitate ignoring some high-end items of lesser significance, such as a prognostic component replacement program.

Computerization

While there is simplification to some elements of management, such as communications, the fact that there are fewer people available means that a comprehensive computerized system is an unavoidable necessity. A fully computerized system is more important for a small mine than a large one. The important thing is to have a simple system that is appropriate to a small mine. An adequate system can be developed from scratch, but it is usually better to obtain a proven program from a maintenance consulting firm that deals regularly (or specializes) in small mines or to copy a good system already used at a comparable mining operation.

Personnel

The full computerization strategy requires that all Maintenance Department personnel be computer-literate to the extent required to operate the selected system.

An additional requirement is employee "cross-training" to allow multi-tasking.

A high personnel turnover in this environment is more harmful to a small operation than a large one; therefore, a special effort should be directed towards assembling and sustaining a stable workforce.

Administration

Even the smallest Maintenance Department needs a system that provides controls and monitors performance. The following items (defined previously in the main body of this chapter) will provide for a basic system that meets the requirements of a typical small mining operation.

- Equipment roster (master list)
- Routine maintenance schedules and checklists
- Work order (job ticket)
- DWS
- Maintenance record logs
- Backlog monitor and control system
- Spare parts inventory control system
- Consumables inventory control system (includes tires, lubricants, etc.)
- Elementary reporting system (equipment operating costs, utilization, and availability)

28.8 Appendix

The following information is provided to augment the data contained in this chapter. The information is divided into the following sections.

- Logs and Certificates
- Sample Work Standard
- Work Standard Abbreviations
- Mine Hoist Lubricants
- Mine Hoist Tools and Equipment

28.8.1 Logs and Certificates

Following is a list of logs and certificates that may be required for a typical hard rock mine.

Logs

- Powder and Fuse Magazine Record Book
- Hoistman's Log Book
- Hoisting Machinery Record Book
- Rope Record Book
- Electrical Hoisting Equipment Record Book
- Record of Overhead and Mobile Crane Inspections
- Hoistman's Medical Record Book
- Diesel Equipment Log Books
- Shaft Inspection Log Book
- Shaft Water Log Book
- Noise Level Record Book

Certificates

- Plant and Pressure Vessel Registration Certificates
- Professional Engineer Certificates and Licenses
- Certified Technician Certificates
- Operating Engineer Certificates
- Hoist Operator Certificates
- Compressor Operator Licenses
- Hoisting Rope Test Certificates

28.8.2 Sample Work Standard

Following is a sample work standard for cleaning a typical unit of LHD equipment based on using a high-pressure (HP) washer. A similar standard would be applicable if a steam generator (steam Jenny) were employed instead.

TORO 301D Wash and Clean with HP unit TIME STANDARD – 4 HOURS		EQUIPMENT UNIT NO.: _____ HOUR METER: _____ Date: _____ Shift: _____		
NOTE: Be sure to keep high pressure away from electrical components		Mechanics Initials		
		OK	RPD	Items Needing Repair
HP WASH				
1	Turn wand to HP setting, loosen and wash off all muck and slimes			
2	Check for leaks on machine			
LP Wash				
1	Turn wand to LP setting and fill detergent canister			
2	Wash engine and compartment			
3	Wash oil coolers thoroughly			
4	Wash undercarriage, including differentials, axles, wheels and planetaries			
5	Wash articulation area, including drive shaft, torque converter and transmission areas.			
6	Completely wash operators area and controls			
7	Wash bucket, including hinge points, lift cylinder and bucket cylinders			
8	Wash fuel and hydraulic tanks			
9	Check again for leaks on machine			

Inspected by: _____ (Foreman)

Reviewed by: _____ (Planner)

Reviewed by: _____ (PM Technician)

Additional comments:

28.8.3 Work Standards Abbreviations

Table 28-9 contains standard computer abbreviations for work (performance) standards.

Table 28-9 Work Performance Standards Abbreviations

ADJ	Adjust	MOD	Modify	RMV	Remove
ALN	Align	MSC	Miscellaneous	SPL	Sample
BRZ	Braze	OEM	Original Equipment Manufacturer	SCR	Scrape
CLN	Clean	OVH	Overhaul	SVC	Service
CHT	Change-out	PPM	Preventive Maintenance	TST	Test
FAB	Fabricate	RBL	Rebuild	TRT	Tire Rotation
GSE	Grease	RCL	Recalibrate	WLD	Weld
ISP	Inspect	RLC	Relocate	WNT	Winterize
IST	Install	RPR	Repair	WSH	Wash
LUB	Lubricate	RPL	Replace		

28.8.4 Mine Hoist Lubricants

Table 28-10 shows lubricants for drum shaft bearings, gears, and oil accumulators.

Table 28-10 Mine Hoist Lubricants

	Exxon	Texaco	Shell	Petrocan
Drum Shaft Bearings				
a) Ring Oiled	Nuto H68	Code 525 Alcaid100	Tellus Oil 68	Harmony AW68
b) Flood Lubrication (pump)	Nuto H68	Code 525 Alcaid100	Tellus Oil 68	Harmony AW68
Ring Oiling Bearings, other than drum shaft	Nuto H68	Code 525 Alcaid100	Tellus Oil 100	Harmony AW100
Drum Bushings, and sliding clutch members	Marvelube Grease 88	Code 924 Marfac 1	Alvania Grease 2	Supreme EP2
Air Cylinders	Nuto H46	Code550 Alcaid 60	Culpor 68	Harmony AW32
Gears, Cut, Enclosed				
a) For Ordinary Temperatures	Spartan EP 680	Code 2321 Meropa 220	Omala Oil 460	Ultima 460
b) For Cold Temperatures	Spartan EP220	Meropa 150	Omala Oil 220	Ultima 220
c) For forced lubrication	Spartan EP220	Code 2321 Meropa 220	Omala Oil 220	Ultima 220
Gears, Not Enclosed	Dynagear	Code 948 Crater 2x	Malleus GL	Tufcote 250
Oil Accumulators, for brake operation	Nuto H46	Code701Regal R&O 46 or N-68	Tellus 32, 46 or 68	Harmony AW32

28.8.5 Mine Hoist Tools, Equipment, and Supplies

- Tools and equipment not normally found elsewhere at the minesite.
 - Kellums grip
 - Rope calipers
 - Wire rope gauge(s)
 - Rope preforming tool
 - Guide template
 - Rope clamps, four bolt
 - Chinese finger
 - Serving tool for applying seizing wire
 - Rope winder/tensioner winch
 - Deflector sheave

- Tools and equipment dedicated to the hoisting plant.
 - Emergency oxygen supply kit (for hoistman at high altitude or underground)
 - Dry chemical fire extinguishers
 - Set of slings and chokers
 - Torque wrench
 - 24-inch channel lock wrench
 - Oil can with long flexible spout
 - 'O' ring identification gauge
 - Volt-ammeter and Megger
 - Walkie-talkie set (dedicated channel, leaky feeder)
 - Two small portable tugger hoists (3,000 Lb. pull)
 - Supplies dedicated to the hoist plant
 - Spare hoist ropes
 - Rope dressing
 - Rope seizing wire, 15 gauge serving wire (0.072 inch)
 - Track limit cable (aircraft cable)
 - Bell cord (aircraft cable)
 - Set of wire and bronze brushes
 - Guide bolts
 - Tugger rope clips
 - Hoist lubricants (refer to Table 28-10)
 - Babbit material (if applicable)
 - Brass shim stock
 - Silver solder
 - Cardstock tag assortment - for lockouts, etc.
 - 'O' ring kit and assortment
 - Grease fitting assortment
 - Visible dye penetrant kit or spray can
 - Gasket kit
 - Dial chalk
 - Loctite[®]
 - Set of easy-outs
 - Crocus Cloth¹
 - IDEAL flexible abrasive strip¹
 - Wood alcohol (methyl hydrate solution)¹
 - SAE - 5W motor oil¹
 - Trichlorethylene¹

¹ for Lilly controllers, if applicable

29.0 Project Management

"Most people assigned to a project, especially those in management positions, do not really understand what the job is, nor what is right or wrong. Moreover, it is not clear to them how to find out."

W. Edwards Deming

29.1 Introduction

The project management (PM) function is to manage, control, co-ordinate, and schedule a project and report on its progress. All types of projects require management; in fact, one project may encompass different phases in sequence. A mining project may comprise an exploration program, feasibility study, engineering design phase and then a construction phase, each requiring project management. This chapter is devoted to the latter. More precisely, it concerns field management of an underground mining project from the point of view of the mining company (the owner). The range of value for mining projects traverses several orders of magnitude; however, only the range between \$50 and \$500 million is addressed here.

The previous chapters in this handbook started off with a list of rules of thumb. When it came to PM, few could be found that met the criteria established in the Forward. Good rules of thumb are based on technical analysis and PM is not a technical science; it is a behavioral science. PM is a discipline requiring business acumen and people skills to accomplish its goals. Hi-tech programs and procedures for cost analysis, scheduling, procurement tracking, and communications facilitate the execution of PM, but do not supplant it – they are no more than useful tools of the trade.

The goal of this chapter is to describe the process, personnel, techniques, and devices that enable PM to be both effective and efficient. One chapter is not sufficient to deal with all facets of PM; therefore, only significant highlights are presented. Rather than present a Tricks of the Trade section (as found in the other chapters), they are included as applicable throughout the text.

29.2 Strategic Planning

Head Start

The clock starts ticking when the official green light (authorization for the major capital expenditure) is issued. When planning begins beforehand, the team has a head start.

Job one is to assemble a planning team. The team may consist of a project leader (pro-tem project manager), a secretary/clerk, and a small group of stakeholders from within the company organization. (The team may also include outside consultants, as required.) The team reports to a high-ranking officer of the company, such as the Vice-President of Operations. The work to be performed by this team is not always at this stage a full-time effort; the individuals involved are expected to continue their normal work functions within the mining company. The planning team does not end when the initial planning is complete; they continue the work by reviewing the performance of their planning efforts, becoming the "management committee."

Reference Document

The final feasibility study is the fundamental reference document for the project. However, such a study is not primarily designed for the purpose of PM. Much of the documentation is not relevant to the project management function. Since the study is normally very lengthy, encompassing volumes of data, it should be abridged. The goal is to produce a condensed version formatted and indexed to produce a practical working document suitable for purposes of planning (and subsequent implementation).

Priority List

"There is no substitute for concise and comprehensive lists of things to be considered or accomplished."

Lester F. Engle

Lists were extensively employed in the construction of the pyramids making them the oldest and most fundamental tool of PM. Separate lists are employed in each aspect of PM, including scope of work, cost accounting, scheduling, and quality assurance. The first one is a task list for project management planning. To be effective, this list should be itemized to include the name of the individual(s) responsible for each task and the target date for completion. With so many planning tasks to be performed, many of which are pressing, it is vital that the list be sorted on the basis of priority.

Each mining project has particular requirements. The following generic starter list is provided to facilitate generation of an actual project-specific list.

- Determine the insurance requirements for the work and ensure that a trigger mechanism is in place whereby all aspects of the project are adequately insured from day one.
- Determine and obtain all the permits required to complete the work.
- If not already decided, determine the method of implementation (i.e., single source design-build contract vs. separate contracts for engineering, project management, and construction).
- If not already decided, determine the type of PM arrangement best suited to the project (in-house, outsourced, or a combination). If the project is to be outsourced, it is wise to consider that ISO 9000 qualification of a design engineering firm may be limited to design and quality assurance procedures; the field management function is often not included.
- As required, formulate (or modify, if required) and issue company policies with respect to environment, business ethics, safety, employment, purchasing, contracting, etc.
- As required, formulate (or modify, if required) and issue design/build policies with respect to value engineering, standardization, substitution of materials, etc.
- Formulate and issue an official goal statement for the project. (The goal is the efficient construction of a mining facility that is technically sound and economically rewarding).
- Produce a definitive scope of work for the project.
- Produce a definitive scope of work for the PM function.
- Produce a manning list (head count) for the PM function.
- Produce a spreadsheet that enables an estimate of man-hours required for the PM function.
- Determine the office facilities required for the PM team, considering the extra space required for visitors and temporary assignees to the project, etc.
- List the necessary office equipment, hardware, and software.
- Perform a definitive cost estimate for PM.
- Draft an organization chart (or matrix function chart) that shows the interrelationship between members of the PM team.
- Write job descriptions for key members of the team that includes qualification requirements.
- Draft the *Project Management Manual* to include, goal, policies, scope of work, design data sheet, procedures (and work instructions) manual, quality control manual, safety manual, and a list of all organizations and personnel directly concerned with the project. The list is to be updated and revised as the project proceeds.
- Determine the level of security required at the project site and formulate the means by which it will be achieved.
- List those items of *infrastructure* in the scope of work that are to be accomplished prior to implementation of the main construction contract(s) for the work. These may include access roads, rail spurs, airport, power transmission lines, telephone lines, natural gas pipeline extension, and port facilities. Determine the means for achievement.
- List those items of *site preparation* in the scope of work that are to be accomplished prior to implementation of the main contract for the work. These may include survey monuments, site grading, soil improvement, fencing, gatehouse, site drainage, water wells, reservoirs, lagoons, tile beds, warehousing, dump sites, powder magazine, campsite (bunkhouse or trailer park), and catering services. Determine the means for achievement.

29.3 Systems and Procedures

“An overload of information, that is, anything much beyond what is truly needed, leads to information blackout. It does not enrich, but impoverishes.”

Peter F. Drucker

The key to efficiency is to implement streamlined systems and procedures from the start. Sophisticated computer programs should be stripped of output not necessary to the proficient execution of the work.

Cost Control

“Cost recording is not cost control. Control can only be exercised before the cost is incurred.”

J.P. Asquith

Cost monitoring is first enabled with a cost account code system. If there is a master document that has the total budget sorted by activity on the official schedule, it can, in turn, be used to generate the required capital expenditure in monthly increments.

The cost accounting system is streamlined when each activity on the schedule is assigned a cost code and a provision for percentage completion. Several 'off-the-shelf' programs are available to accomplish this requirement. By tying the cost accounts to the schedule, direct costs may be entered as they occur. Most of the indirect costs are time related and so the system can readily accommodate and integrate these costs. The procedure provides for close cost monitoring and cost analysis on a timely basis. The rapid identification of cost trends and the projection of schedule delays are essential if remedial action (cost control) is to be effective.

Safety Orientation

Persons visiting the site are normally required to undergo a safety orientation routine before entering the work site. The orientation can be accomplished efficiently with a video presentation and a test afterwards, neither of which require the presence of a safety officer who only needs to correct the test results and hand out a certificate and/or a decal to be affixed to the visitor's safety hat. Anyone who fails the test is required to view the video again, until the test is passed.

Document Control

All project drawings (except for field sketches and lift sheets) should be created electronically. Standard drawing sizes should be chosen and used. Standard layering and program specifications (i.e. AutoCAD 2000[®]) should be selected and adhered to for all electronic drawings. A standard numbering system should be adopted. The practice of having several drawings with the same number that reference sheet 1, 2, and 3 should be avoided. Drawings that are revised or otherwise obsolete should be so denoted and transferred to a separate computer file that disallows printing. Even drawings stamped "For Construction" may have a subsequent revision.

Letters, e-mail correspondence, records of telephone conversations, and memos should be filed to facilitate retrieval. For this purpose, copies of one document may be filed in two or three places, thereby avoiding the requirement for (and the inefficiency of) cross-referencing.

Quality Controls records (field forms, certificates, etc.) should be duplicated for distribution as applicable. The original documents should be filed in a vault in the project manager's office.

Requests for quotation (RFQs), purchase orders, packing slips, and receipt acknowledgements should be monitored and controlled with a computerized tracking program (available off-the-shelf). In some cases, it is expedient to link the purchasing function directly to the purchasing department of the owner. In other cases, it has been found desirable to outsource equipment purchases to the appropriate design engineering firm.

29.4 Execution

Quality Assurance

Inspection and testing are documented on forms included in the PM manual described previously. The forms are essentially lists of what to look for and what to measure. They are designed to identify non-conformance with regard to tests and inspections performed.

It is important to have a list of all quality assurance devices that includes the following information.

- Functional description
- Identification
- Location
- Calibration interval
- Calibration procedure
- Acceptance criteria
- Action for unsatisfactory results

Shop inspections at manufacturer's facilities should normally be outsourced. Usually, the design engineering firm is the best candidate for this task as these are the people acquainted with the project and qualified to do the work. It is disruptive to have PM team members away from the site, traveling across the country, or overseas.

Prompt and decisive corrective action to resolve items of non-conformance is essential to efficient management of the quality control program.

Contract Administration – Boiler Plate and Armor Plate

“When people make contracts, they usually contemplate the performance rather than the breach.”

Fuad Rouhani

Do not design contract and purchase order documents from scratch. Start with a model set of documents the general wording (“boiler plate”) of which has stood the test of time. The only parts of a document that should deviate from the tried and true language are the Special Conditions and the Technical Specifications.

An important duty of the PM team is to ensure that there are good records of the work performed and other precautions taken to make the project safe (“bulletproof”) from avoidable or unfounded claims for extra payments. For example, issuing separate contracts for the excavation and concrete placement in an underground crusher room is akin to cutting a blank check (to pay for extra concrete required to fill overbreak). The following list characterizes a project run by experienced PM professionals.

- Verify that daily reports are complete and correct.
- Files are orderly archived in a safe location.
- Correspondence received that contains inaccuracies is not left unanswered.
- Errors in the minutes of meetings are corrected on record.
- Claims for extras are promptly dealt with and finalized.
- Photographic records of every aspect of the construction. (Digital photos may not be accepted as evidence in arbitration or litigation because of the ease with which they can be manipulated.)
- Problems are fairly dealt with and resolved expediently.
- Ethical principles are adhered to in all aspects of PM.
- Absence of malice is an axiom of management.

Safety

The PM team invariably employs a stand-alone safety officer. It is important to understand that the safety officer is not the only one responsible for safety – the whole team is responsible. The safety officer is often expected to be immediately available, day or night; however, this is not a practical arrangement. Instead, it is important to cross-train other members of the team so that one of them can substitute for the safety officer when necessary.

The principal of cross training (also called “multi-tasking”) applies to other talents required by individual members of the project team. Ideally, no person on the team should be indispensable.

Value Engineering and Standardization

If everyone is thinking alike, then somebody isn't thinking.

General George S. Patton

Value engineering is the review of plans, drawings, schedules, and specifications with the aim of making advantageous substitutions or design changes by innovative means. The goal is to reduce the projected capital or operating costs and/or shorten the schedule. The PM team should always be receptive to suggestions from operations, contractors, vendors, and engineering firms. The proposals will die on the vine if there is no formal mechanism in place to evaluate and approve (or deny) them.

The greatest opportunity for cost savings come from procedures that shorten the total project schedule. For example, ten months were saved on the Elandstrand Mine construction project by devising means to complete critical tasks concurrently that were originally scheduled in sequence.

The implementation of standardization may slightly increase the capital cost, but it is usually worthwhile if it reduces operating costs and maintenance frustration. (A list of opportunities for standardization is found in Chapter 28 Mine Maintenance.)

Constructability

People that have never worked directly in mine construction often produce the detail design drawings and their ‘hands-on’ experience in the field may be very limited. The remedy is to have an individual experienced in construction methods and procedures review the drawings. This person should attend the technical review meetings described later in the text.

Pre-fabrication and Modular Construction

The design drawings, specifications, purchase orders, and contract documents should be reviewed for opportunities to pre-fabricate off-site or on-surface before transport to the work place underground.

The opportunities may be obvious for mechanical components, but they are often forgotten when it comes to electrical installations. It is not uncommon to see full lengths of Cantruss[®] shipped underground for fabrication and assembly at the place of installation.

Meetings

"I hold regularly scheduled meetings once a week. I listen while my people review and analyze what they accomplished last week, the problems they had, and what still needs to be accomplished. Then we develop plans and strategies for the next week."

The One Minute Manager

Twenty percent of the cost of PM may be consumed in meetings. Meetings are an important management tool and should not be underestimated in value. The aim is to promote the employment of meetings while ensuring that they are conducted efficiently and wisely. Different kinds of meetings are necessary, such as kick-off, progress review, technical review, hazard analysis (HAZOP), contract negotiation, and problem solving. Regardless of its purpose, every meeting should be scheduled ahead of time and provided with an itemized agenda (another list). As well, every meeting needs a chairperson (conductor) responsible for its initiation, attendance, agenda, and conduct. A meeting is worth nothing if it does not produce results. The results must be recorded in the minutes of the meeting, which need to be promptly typed up and distributed to all concerned for the required action.

Perhaps the most important are technical review meetings. Having drawings and the like approved remotely by those responsible (departmental representatives, etc.) is inefficient. The most effective method is to conduct technical reviews in *meetings* that provide interaction and immediate feedback. When physical distances are a problem, technical review meetings may be conducted by teleconferencing or even videoconferencing.

MBWA

Management by walking around (MBWA) is a useful tool for mining projects. A good time for the project manager to rapidly tour the working areas with minimal interruption is usually very early in the morning, before the 'crowds' arrive. All members of the project team should visit the work site from time to time for better awareness of progress and problems. They should always be instructed to keep an eye out for environmental hazards, WHMIS infractions, and unsafe conditions or practices. For this purpose, it is important to have the PM offices immediately adjacent to the jobsite. Sometimes, the management offices are located a mile or more away, which is unsatisfactory.

Reports

Besides the official monthly progress reports, the PM team is invariably responsible to produce technical reports concerning particular aspects of the work ("side studies"). These reports are an important part of the work to be done. The procedure and format for writing, reviewing, approving, and implementing results should be formalized and streamlined from the outset. The following guidelines are suggested for these reports:

- Affix a comprehensive title.
- Identify by name and title the individual(s) to whom the report is addressed.
- Name and title identify the author(s) of the report.
- Clearly outline the scope of the work.
- Delineate the criteria in detail.
- Clearly define assumptions and do not bury them in the text.
- Clearly spell out references to other reports and studies.
- Document the interfaces of one report with another to avoid redundancy or omission.
- Explicitly define terms ("variable costs" have a different meaning to different people).
- Edit the report to ensure the assumptions are correct.
- Ensure senior people review the report in a formal manner with critical comments recorded.
- Promptly incorporate recommendations that are physical in nature into the scope of work for the project when officially approved.

Commissioning

It will gather speed till your nerves prepare to hear it wreck.... But it's cotter-pinned, and bedded true. Everything its parts can do has been thought out and accounted for.

Robert Frost

The commissioning of equipment is the procedure whereby equipment and systems of equipment are test run after being installed. Commissioning is typically divided into the following stages.

- Pre-commissioning
- Dry commissioning (manual)
- Dry commissioning (electronic)
- Wet commissioning (manual)
- Wet commissioning (electronic)
- System commissioning (electronic/remote)
- Official commissioning

Pre-commissioning

Pre-commissioning occurs before any commissioning begins. Tests are completed, including verifications that bolts are torqued, reservoirs filled, nipples greased, electrical grounds tested, guards installed, etc.

Dry Commissioning (Manual)

In general, the first running test on a unit of equipment is a dry run ("dry commissioning") under condition of no load, carried out under manual control.

Dry Commissioning (Electronic)

The manual procedure is then repeated under PLC (electronic control) and remote control.

Wet Commissioning (Manual)

The next step is a manually operated test run under load ("wet" or "hot" commissioning). The wet commissioning stage may include calibration of controls, weightometers, etc. Normally, the equipment is run for at least four hours to check for leaks and hot bearings.

Wet Commissioning (Electronic)

The manual procedure is then repeated under PLC and remote control.

System Commissioning (Electronic/Remote)

Finally an entire system of equipment is tested under PLC and remote control. The whole procedure is described as "getting the bugs out."

Official Commissioning

Official commissioning is a subsequent step in which plant start-up consists of a ceremony attended by dignitaries.

The importance of having a carefully planned, properly organized rigid routine for commissioning cannot be overemphasized. Inadequate procedures have, in the past, led to grave problems such as damaged equipment, explosions, electrocution, fires, major spills, runs of muck, and even structural failures.

For these planning purposes, lists are employed once again. The first is a task list identifying those responsible for the various areas of concern (electrical, mechanical, electronic, etc.). The second is an operations checklist that includes extra fire protection, adequate supply of spares, special tools, inspection points, calibration procedures, availability of equipment manuals, etc. An important planning strategy is to anticipate problems and determine the remedies in advance. For example, Table 29-1 shows a "trouble shooting" matrix developed for commissioning the feeder at an ore pass load out to a belt conveyor.

Table 29-1 Commissioning Trouble Shooting Matrix

Problem	Condition Noted	Remedy
Unable to feed belt at full capacity	Bed height on feeder < 900mm (Problem is control chains)	1. Check guillotine gate is fully open 2. Check press frame is fully opened 3. Remove doughnut weights as required on chain counterweight assembly 4. Shorten chain length
	Bed height on feeder >900mm (Problem is with feeder)	1. Check vibrator op. manual for full capacity setting/ trouble shooting 2. Increase inclination of feeder apron grizzly
Unable to control capacity (overfeed)	Bed height on feeder >900mm	1. Add weights to chain counterweight assembly as required. 2. Tie chains together as required 3. Install baffles on chute sides
Unable to control capacity (irregular feed)	Irregular bed height on feeder apron	1. Adjust individual counterweights (add/remove weights)
Hang-up in discharge chute (bootjack)	If regular occurrence	1. Install spacers to lift chute assembly 2. Install spacers to move out rock box from apron end 3. Field cut chute opening as required
Excessive vibration	Jerk or chatter when hydraulic system components activated	1. Purge trapped air from hydraulic system 2. Throttle or choke connections 3. Changeout dirty hydraulic oil.
Flyrock or spill from throat area over chute sides		1. Tie chains together 2. Add chute side boards
Video camera lens broken	Flyrock	1. Tie chains together 2. Re-position camera

Visitors

Typically, a very large number of people visit the PM office. Regular visitors include individuals such as mine inspectors, other government inspectors, vice-presidents, president's aides, local politicians, internal auditors, IRS agents, consultants, experts, union business agents, salesmen, stock analysts, adjacent landowners, computer program specialists, computer hardware repairmen, quality control technicians, telephone repairmen, job applicants, vendor's equipment erectors, contractors, sub-contractors, department heads, transport drivers, appliance repairmen, vending machine agents, janitors, cleaning ladies, deliverymen, couriers, mailmen, painters, plumbers, roof repairmen, fire department inspectors, insurance adjusters, and police constables. Besides the individual intrusions, there are groups of visitors such as the management committee, independent auditors, safety committee, entire board of directors, engineering-design firm representatives, student delegations, post-convention tours, indigenous peoples assemblies, and, of course, no project is completed without a delegation from Russia.

Incorporating the following activities best accommodates this influx of people.

- Incorporate a regimented procedure to schedule visits, especially groups of people.
- Allow no non-routine visits except by prior appointment.
- Incorporate the streamlined safety orientation procedure previously explained.
- Create a furnished waiting room in the reception area.
- Create a large conference room (in addition to a regular meeting room).
- Create a video presentation, set up for repetitive, automatic, operation.
- Ensure that adequate toilet and changehouse (dry) facilities are near at hand.
- Designate a parking area for visitors.
- Purchase inexpensive souvenirs, such as site-specific brochures, decals, or small ore samples.

- Maintain an empty office fully equipped for an individual visitor (or two).
- Create a lunchroom (equipped with vending machines) that can double as a visitor's office.
- Keep on hand spare hard hats, respirators, safety boots, safety glasses, safety belts, lanyards, gloves, ear plugs (or muffs), towels, and throw-away paper overalls (dispensed only as necessary).
- Provide an abridged project manual (that includes the design data sheet) to save numerous questions.

One of the enigmas of PM is that a mining company is often reluctant to approve the modest expenditure required to properly accommodate visitors during the course of the work. Later on, these same people eagerly authorize a generous budget to suddenly provide these facilities (and a lot more) when it comes time to prepare for visitors attending the official opening ceremony that lasts for only one day or less.

Appendix I – Properties of Miscellaneous Materials

I.1 Fuels

The combustion energy of a liquid engine fuel (i.e. gasoline, diesel or propane) is directly proportional to its density. A reciprocating engine will consume approximately 0.20 kg (0.44 Lbs.) of fuel per HP-hour when operating under load. When idling, fuel consumption is about 20% of this amount. A gas turbine engine will consume approximately 40% more (heating value of) fuel per HP-hour than a reciprocating engine.

Table I-1 Properties of Common Fuels

Fuel	Heating Value	Specific Gravity	Rec. Engine Fuel Consumption (typical)
Propane	92,000 Btu/US gal	0.51 (liquid) (water = 1.0)	11,000 Btu/HP·hour
Natural Gas	980 - 1160 Btu/ft ³	0.61 (air = 1.0)	11,000 Btu/HP·hour
Gasoline	125,000 Btu/ US gal	0.70 - 0.78 (water = 1.0)	11,200 Btu/HP·hour
Jet Fuel, JP4 (turbine)	142,000 Btu/ US gal	0.75 - 0.80 (water = 1.0)	N/A
No.1 Diesel (arctic grade)	135,000 Btu/ US gal	0.816 (water = 1.0)	8,300 Btu/HP·hour
No. 2 Diesel (furnace oil)	142,000 Btu/ US gal	0.876 (water = 1.0)	8,900 Btu/HP·hour

Notes

- 1 US gallon = 3.786 litres = 0.1337 cubic foot = 0.8327 imperial gallon
- 1 imperial gal = 1.201 US gal = 4.547 litres
- 1Btu = 1.055 kJ

I.2 Modulus of Elasticity, E

Table I-2 Modulus of Elasticity, E

Material	E (psi)	E (MPa)
Steel	29.6 x 10 ⁶	200,000
Ductile Iron	25 x 10 ⁶	170,000
Cast Iron	19 x 10 ⁶	130,000
Bronze	16 x 10 ⁶	110,000
Lock coil wire rope	14.3 x 10 ⁶	100,000
Stranded wire rope	8.5 x 10 ⁶	60,000
25 MPa (3,500 psi) concrete	3.3 x 10 ⁶	23,000

I.3 Mine Timbers and Posts

Sections 150 by 150 (6-inches by 6-inches) and larger, for underground service (wet conditions).

Table I-3 Properties of Mine Timbers and Posts

SPECIES	SOURCE	GRADE	S.G. @ 12% MC	S.G. @ Green	Modulus of Elasticity, E		ALLOWABLE STRESSES					
							Bending		Compression Grain ²		Compression ⊥ Grain	
					MPa	ksi	MPa	psi	MPa	psi	MPa	psi
Apitong-Keruing ¹	Malaysia	None	varies	varies	12,342	1,790	14.10	2,043	10.10	1,470	2.11	306
Balsam Fir	North East	Select*	0.38	0.74	7,584	1,100	8.07	1,170	5.58	810	1.38	200
	N. America	Structural	0.38	0.74	6,895	1,000	6.52	945	4.65	675	1.38	200
		No.1	0.38	0.74	6,895	1,000	5.21	756	3.72	540	1.38	200
Douglas Fir (B.C. Fir)	West Coast	Clear*	0.50	0.64	10,756	1,560	11.80	1,710	10.20	1,485	1.92	278
	N. America	Select*	0.50	0.64	9,653	1,400	11.80	1,710	10.20	1,485	1.92	278
		No.1	0.50	0.64	8,274	1,200	11.50	1,667	8.69	1,260	1.79	260
Eastern Spruce	North East	Select*	0.42	0.60	8,274	1,200	8.07	1,170	5.58	810	1.38	200
	N. America	Structural	0.42	0.60	7,584	1,100	6.52	945	4.65	675	1.38	200
		No.1	0.42	0.60	7,584	1,100	5.21	756	3.72	540	1.38	200
Karri	SW Australia	None	0.90	1.20	14,272	2,070	16.20	2,354	12.10	1,750	2.52	366
Tamarack (Eastern Larch)	North East	Select*	0.54	0.76	8,274	1,200	9.31	1,350	7.14	1,035	1.52	220
	N. America	Structural	0.54	0.76	7,584	1,100	7.45	1,080	5.90	855	1.52	220
		No.1	0.54	0.76	7,584	1,100	5.96	864	4.72	684	1.52	220

¹ "Mahogany"

² Allowable compressive stresses must be reduced for posts or columns with a slenderness ratio (L/d) greater than ten. (i.e. by 15% @ L/d = 20, by 36% @ L/d = 25). Where L is length of post, d is the smaller width.

LEGEND

Clear* – Knot-free on face and edges

Select* – Select Structural Grade

No. 1 - Construction Grade

I.4 Properties and Measurement of Gold

Tables I-4 and I-5 show gold properties and Measurements. Tables I-5 and I-6 show measurement and grade conversions.

Table I-4 Gold Properties

Gold Properties	
Symbol	Au
Atomic Number	79
Atomic weight	196.967
Specific Gravity	19.32
Melting Point	1063°C = 1945°F
Modulus of Elasticity	11.2×10^6
Poisson's Ratio	0.42
Cyanide Solution	$Au + 2CN = Au(CN)_2$
Aqua Regia Solution	$(Air) + HNO_3 + 4HCl + Au = HAuCl_4 + H_2O + HNO_2$

Table I-5 Gold Measurement

Measurement
<i>Purity</i>
24 carats = pure gold
18 carats = 75% gold
<i>Weights</i>
1 troy oz. = 31.10348 grams
1 troy oz. = 20 pennyweights
1 troy oz. = 480 grains
1 troy oz. = 1.0971 avoirdupois oz.

Table I-6 Measurement Conversion

Grains	Penny Weights	Troy Ounces
1	0.04167	0.00283
24	1	0.05
480	20	1
5760	240	12 = 1 troy lb.
7000	292	14.583 = 1 avoirdupois lb.

Table I-7 Grade Conversions

g/tonne	oz./ton	oz./ton	g/tonne	oz./ton	oz./ton
1	0.03	0.029167	19	0.55	0.554167
2	0.06	0.058333	20	0.58	0.583333
3	0.09	0.087500	21	0.61	0.612500
4	0.12	0.116667	22	0.64	0.641667
5	0.15	0.145833	23	0.67	0.670833
6	0.18	0.175000	24	0.70	0.700000
7	0.20	0.204167	25	0.73	0.729167
8	0.23	0.233333	26	0.76	0.758333
9	0.26	0.262500	27	0.79	0.787500
10	0.29	0.291667	28	0.82	0.816667
11	0.32	0.320833	29	0.85	0.845833
12	0.35	0.350000	30	0.88	0.875000
13	0.38	0.379167	31	0.90	0.904167
14	0.41	0.408333	32	0.93	0.933333
15	0.44	0.437500	33	0.96	0.962500
16	0.47	0.466667	34	0.99	0.991667
17	0.50	0.495833	35	1.02	1.020833
18	0.53	0.525000	36	1.05	1.050000

Appendix II – Statistical Tools

II.1 Standard Charts

Flow Chart

A flow chart (example on the right) is a pictorial representation showing all of the steps of a process. Flow charts use easily recognizable symbols to represent the type of processing performed.

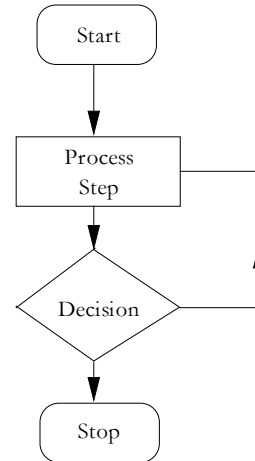

Pareto Chart

A Pareto chart is a special form of vertical bar graph that helps one to determine which problems need to be solved, and in which order.

Fishbone Chart (Cause and Effect)

The fishbone diagram was developed to represent the relationship between an “effect” and all possible “causes” influencing the effect. The following example shows the possible causes of dilution in a mine.

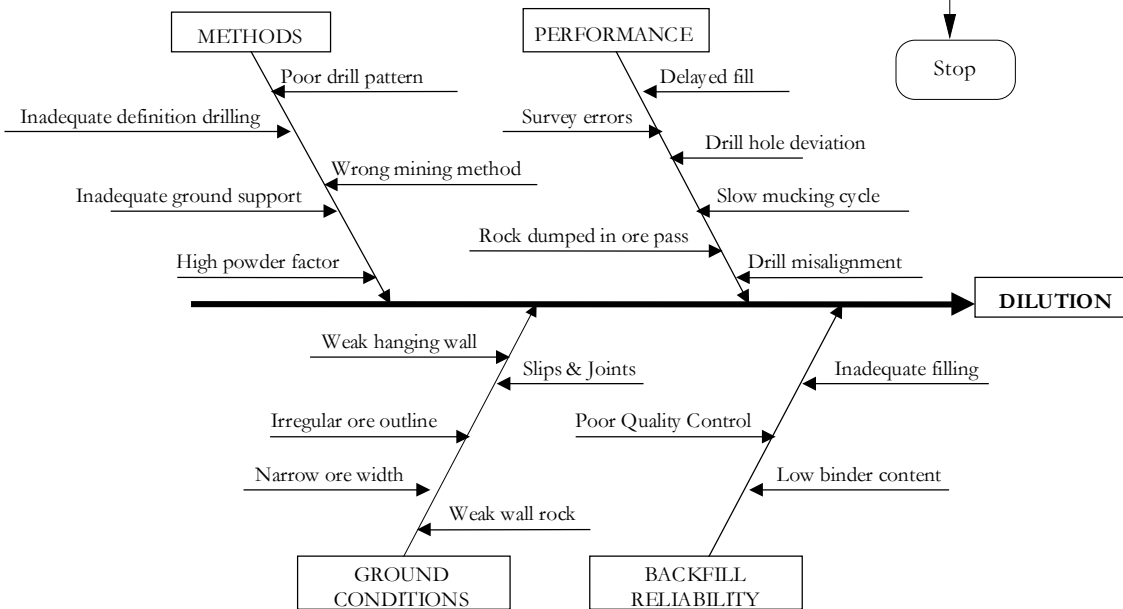

Run Chart

Run charts (example shown below) are employed to visually represent data. Run charts are used to monitor a process to see whether or not the long-range average is changing.

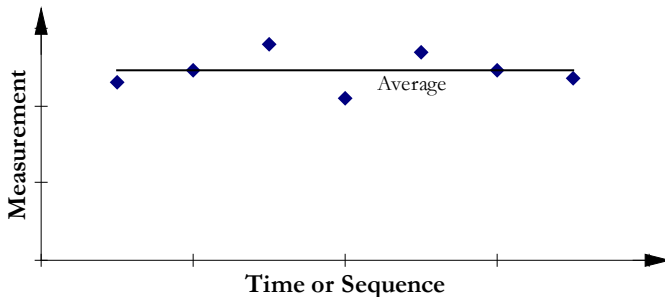

Histogram

A histogram takes measurement data and displays its distribution as a bar style graph. The data's variability and skewness can be easily identified by this presentation. Probabilities, variance, and standard deviation can be easily estimated using a histogram.

Scatter Diagram

A scatter diagram can be used to study the possible relationship between one variable and another. This can be useful in testing for cause and effect relationships.

Control Chart

The control chart is the most important of the statistical tools. A control chart is simply a run chart with statistically determined upper and lower limits (drawn on either side of the process average).

Appendix III Directory of Web Sites

Company or Organization	Address
AATA International (environmental consultant)	www.aata.com
Aeroquip Industrial Division (hydraulic hose)	www.aeroquip.com
Alimak AB (raise climbers)	www.alimak.se
American Mine Services Inc.(mining contractor)	www.americanmineservices.com
ASARCO (major)	www.asarco.com
Ashtec Magellan (GPS instruments)	www.ashtec.com
ATCO (mine camps)	www.atco.ca
Australasian Mining Association	www.ausimm.com.au
Autodesk Inc (AutoCAD drafting)	www.autodesk.com
Behre Dolbear (engineers)	www.dolbear.com
Blattner & Sons (mine contractor)	www.dhblattner.com
Barrett, Haentjens & Co.	www.hazletonpumps.com
Boart Longyear Ltd	www.boartlongyear.com
Bodine Electric Company (garmotors and controls)	www.bodine-electric.com
Boyles, JKS International (drilling)	www.jksboyles.com
CAMESE	www.camese.org
Caterpillar Inc.	www.cat.com
Cattron Inc (LHD remote controls)	www.cattron.com
Chemex Labs (assayers)	www.chemex.com
Christensen Mining (DD bits)	www.christensenproducts.com
Canadian Institute of Mining, Metallurgy and Petroleum	www.cim.org
Compass Minerals Group (NASC, GSL, Sifto)	www.compassminerals.com
Concrete Reinforcing Steel Institute, CRSI	www.crsi.org
Crown Publications Inc. (maps)	www.crownpub.bc.ca
Crushing and Mining Equipment	www.crushingandmining.com.au
Cummins Engine Co Inc	www.cummins.com/na/pages/en/products/mining/index.cfm
Datamine (software)	www.datamine.co.uk
Denver Mineral Engineers	www.denvermineral.com
Derrick Corporation (screens)	www.derrickcorp.com
Detroit Diesel Corporation	www.detroitdiesel.com
Doofor Rock Drills	www.doofor.com
Duoling-watson (crushers)	www.dl-w.com/ENGLISHVIEW/index.html
Dynatec (mine contractor)	www.dynatec.ca
Eagle Crusher Company Inc.	www.eaglecrusher.com
EBA Engineering (civil)	www.eba.ca
EFCO (concrete formwork)	www.efco-usa.com
E &MJ (mining magazine)	www.e-mj.com
Engineered Coatings Ltd. (ground support)	www.engineeredcoatings.com
Engineering News Record (journal)	www.enr.com
Envirotech Pumpsystems (pumps)	www.envirotech.nl
Esco Corporation	www.escocorp.com
Falk Corporation	www.falkcorp.com
Gemcom Services Inc.	www.gemcom.bc.ca
Geomechanics Research Centre (Laurentian U.)	www.mirarco.org
Gorman Rupp	www.gormanrupp.com
Goodyear Tire and Rubber Co.	www.goodyear.com
Hatch Associates (engineers)	www.hatch.ca
Hayward Baker (Soil Stabilization Contractor)	www.haywardbaker.com
Hazemag, Inc. (roll crushers)	www.hazemag.com
Hecla Mining Company (major)	www.hecla-mining.com
Hitachi Construction Machinery	www.hcmac.com
IMM (British Institution of Mining and Metallurgy)	www.imm.org.uk
INCO (major)	www.inco.com
Industrial Minerals (journal)	www.indmin.com

Company or Organization	Address
Info-Mine	www.info-mine.com
INFOSAT (satellite telecommunications)	www.infosat.com
Ingersoll-Rand Company	www.ingersoll-rand.com
Instantel (blast monitoring)	www.instantel.com
Institute of Explosives Engineers	www.iexpe.org
Jacques Whitford (environmental engineers)	www.jacqueswhitford.com
John Deere	www.deere.com
Johnson Screens/Wheelabrator	www.johnsonscreens.com
Kent Demolition Tools	www.kentdemolition.com
Knelson Concentrators	www.knelson.com
Komatsu Mining	www.komatsu-mining.com
Lakefield Research (assays & testing)	www.lakefield.com
Lincoln Electric (welding equipment)	www.lincolnelectric.com
Lippmann Milwaukee Inc. (jaw crushers)	www.lippmann-milwaukee.com/jawcrusher.html
Major Drilling Group International (diamond driller)	www.majordrilling.com
Master Builders (concrete & backfill additives)	www.masterbuilders.com
MK Centennial (mine contractor)	www.mkcentennial.com
MSA (cap lamps & mine safety gear)	www.msanet.com
Maptek (<i>Vulcan</i> mine software)	www.maptek.com
McDowell Equipment (used LHDs)	www.bmcdowell.com
Metso Minerals (Nordberg) (process machinery)	www.metsominerals.com
Micon International (engineers)	www.micon-international.com
Mine Engineer.Com (general information)	www.mine-engineer.com
Mine Ventilation Services (engineers)	www.mvsengineering.com
Mining Journal (UK)	www.mining-journal.com
Ministry of Northern Development & Mines (Ontario)	www.gov.on.ca/MNDM
Minyu Machinery Corporation Ltd.	www.minyu.com/jaw.htm
Mount Sopris Instruments (geophysics)	www.mountsopris.com
Nokian (LHD tires)	www.nokiantyres.fi
Northwest Mining Association	www.nwma.org
Norcast Inc.	www.norcast.com
Northern Miner Press	www.northernminer.com
Paterson Grant & Watson (geophysicists)	www.pgw.on.ca
Peacock (pumps, etc.)	www.peacock.ca
Pearl Weave (safety nets)	www.pearlweave.com
Pincock Allen & Holt Inc. (engineers)	www.hartcrowser.com/pah/index.html
PR Engineering (crushers)	www.preengineering.com
Placer Dome (major)	www.placerdome.com
Primavera (software)	www.primavera.com
Prospectors and Developers Association	www.pdac.ca
RS Means (Cost & Price data)	www.rsmeans.com
Redpath, J.S. Ltd. (mine contractor)	www.jsredpath.com
Rexnord Corporation	www.rexnord.com
Ritchie Bros. (auctioneers)	www.rbaction.com
Runge Mining (consultants)	www.runge.com
Sander Geophysics (airborne surveys)	www.sgl.com
Salt Institute	www.saltinstitute.org
Sandvik Tamrock Canada (rock bits & drill steel)	www.tamrockcanada.com
Stantec (engineers)	www.stantec.com
Schauenburg Flexadux Corporation (vent)	www.schauenburg-us.com
Scotia Mocatta (metal traders and bankers)	www.scotiacapital.com
SeaNet (shipping industry)	www.seanet.co.uk
Scintrex (geophysical instruments)	www.scintrexltd.com
Siemag GHH (mine hoists)	www.siemag.de
Smith International (drilling)	www.smith-intl.com
Society for Mining, Metallurgy, and Exploration Inc.	www.smenet.org
Springfield Resources (maintenance management)	www.maintrainer.com
SRK (engineers)	www.srk.com

Company or Organization	Address
Teck Cominco Ltd. (major)	www.teckcorp.ca
Terex Corporation (equipment)	www.terex.com
ThyssenKrupp Rockbreakers	www.thyssenkrupp.com
Tracks and Wheels Equip Inc.	www.tracksandwheels.com
Trelleborg	www.trellgroup.se
TSX Group (Canadian Stock Exchange)	www.tse.com
Tyco Engineered Products and Services	www.tycoflow.com
U S Geological Survey	www.usgs.gov
University of B C, Dept. Mines & Mineral Processing	www.mining.ubc.ca/rock
VDMA (German mine equipment)	www2.vdma.de
Warman (pumps & valves)	www.warmanintl.com
Varis Mine Technology Ltd. (leaky feeder)	www.varismine.com
Volvo Construction Equipment	www.construction.volvo.se
VWR International (weigh cells)	www.vwrcanlab.com
Warren Rupp	www.warrenrupp.com
Washington Group International (Morrison Knudsen)	www.wgint.com
Western Mine Engineering (cost estimating)	www.westernmine.com
Whittle Strategic Mine Planning (mine software)	www.whittle.com.au
Wilden Pump & Engineering Co. (pumps)	www.wildenpump.com
Wire Rope Corporation of America Inc.	www.wrca.com
World Mine Cost Data Exchange	www.minecost.com
World Mining Equipment (journal)	www.wme.com
Yukon Chamber of Mines	www.gov.yk.ca
Zeni Drilling Co. (shaft drilling contractor)	www.zeni.com

Appendix IV – Conversion Factors and Constants

Mass & Density

1	kg	=	2.204600	Lb.
1	Lb.	=	0.453600	kg
1	kg/m ³	=	0.062428	Lb./ft ³
1	Lb./ft ³	=	16.018000	kg/m ³
1	g	=	0.035274	oz. (avoirdupois)
1	g	=	0.032151	oz. (troy)

Length

1	cm	=	0.3937	in.
1	in.	=	2.5400	cm
1	m	=	3.2808	ft
1	ft	=	0.3048	m

Area

1	ha	=	2.471050	acre
1	acre	=	0.404686	ha

Velocity

1	km/h	=	0.62137	mile/h
1	mile/h	=	1.60930	km/h

Volume

1	cm ³	=	0.061024	in. ³
1	in. ³	=	16.387000	cm ³
1	m ³	=	35.314700	ft ³
1	ft ³	=	0.028317	m ³
1	L	=	0.035300	ft ³
1	USgal	=	0.003785	m ³
1	USgal	=	0.133680	ft ³
1	USgal	=	0.832680	IMPgal

Force

1	N	=	0.22481	lbf
1	lbf	=	4.44820	N
1	lbf	=	32.17400	lb·ft/s ²

Pressure

1	Pa	=	0.000145	lbf/in. ²
1	lbf/in. ²	=	6,894.757000	Pa
1	bar	=	100,000	Pa
1	lbf/in. ²	=	144	lbf/ft ²
1	atm	=	1.013250	bar
1	atm	=	14.696000	lbf/in. ²

Energy

1	J	=	0.737560	ft·lbf
1	ft·lbf	=	1.355820	J
1	kJ	=	0.947800	Btu
1	Btu	=	1.055100	kJ
1	kJ/kg	=	0.429920	Btu/lb
1	Btu/lb	=	2.326000	kJ/kg
1	J	=	0.238846	cal
1	kcal	=	4.186800	kJ

Power

1	W	=	3.4130	Btu/h
1	Btu/h	=	2.9300	W
1	kW	=	1.3410	hp
1	hp	=	2545.0000	Btu/h
1	hp	=	550.0000	ft·lbf/s
1	hp	=	0.7457	kW

Specific Heat

1	kJ/kg·K	=	0.238846	Btu/lb·°R
1	Btu/lb·°R	=	0.293	kJ/kg·K

Universal Gas Constant

$$R = \frac{8.314 \text{ kJ/kmol}\cdot\text{K}}{1545.000 \text{ ft}\cdot\text{lbf/lbmol}\cdot\text{°R}}$$

$$1.986 \text{ Btu/lbmol}\cdot\text{°R}$$

Standard Acceleration due to Gravity

$$g = \frac{9.8067 \text{ m/s}^2}{32.1740 \text{ ft/s}^2}$$

Standard Atmospheric Pressure

$$1 \text{ atm} = \frac{1.0133 \text{ bar}}{14.6960 \text{ lbf/in.}^2}$$

Temperature Relations

$$T(\text{°R}) = 1.8 T(\text{K})$$

$$T(\text{°C}) = T(\text{K}) - 273.15$$

$$T(\text{°F}) = T(\text{°R}) - 459.67$$

VOLUME

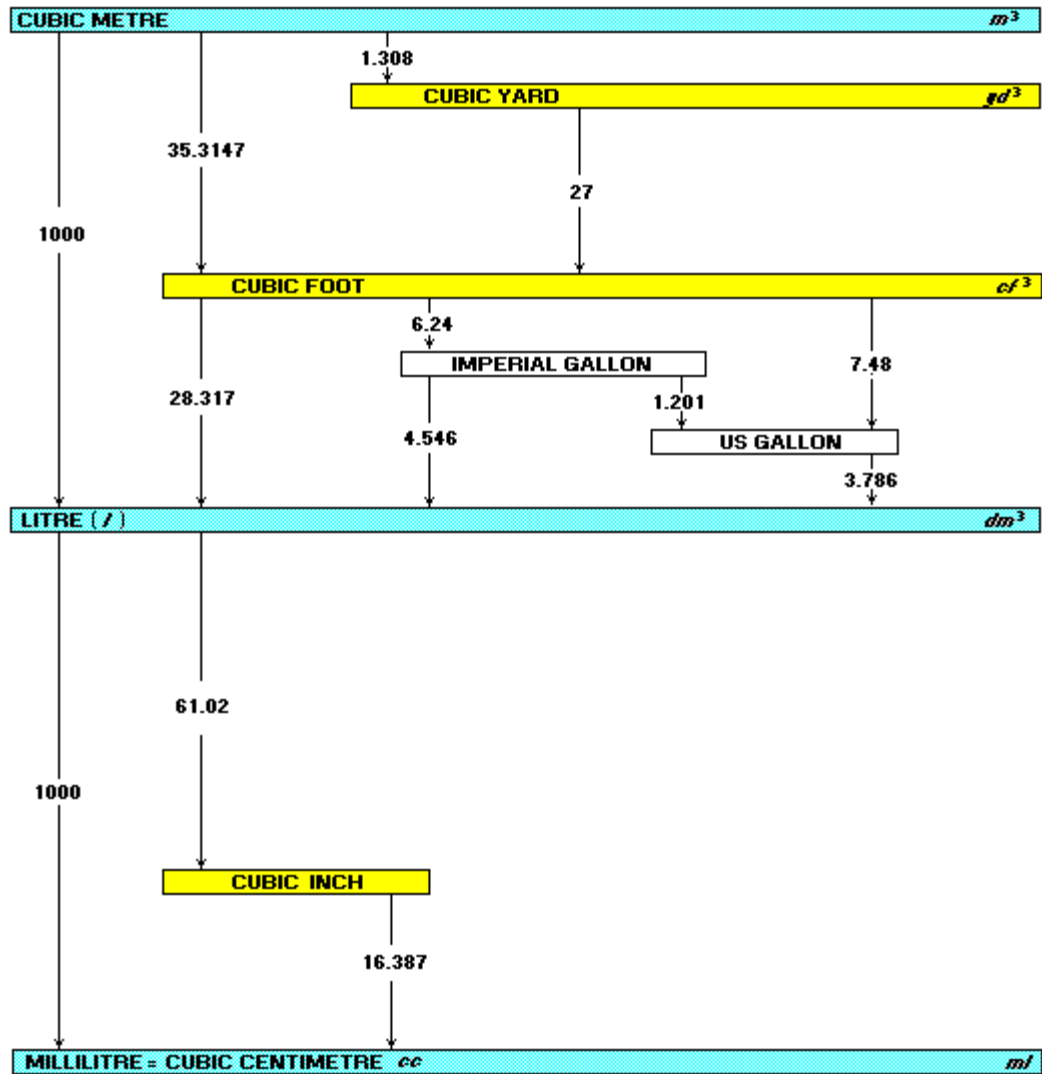

WEIGHT & FORCE

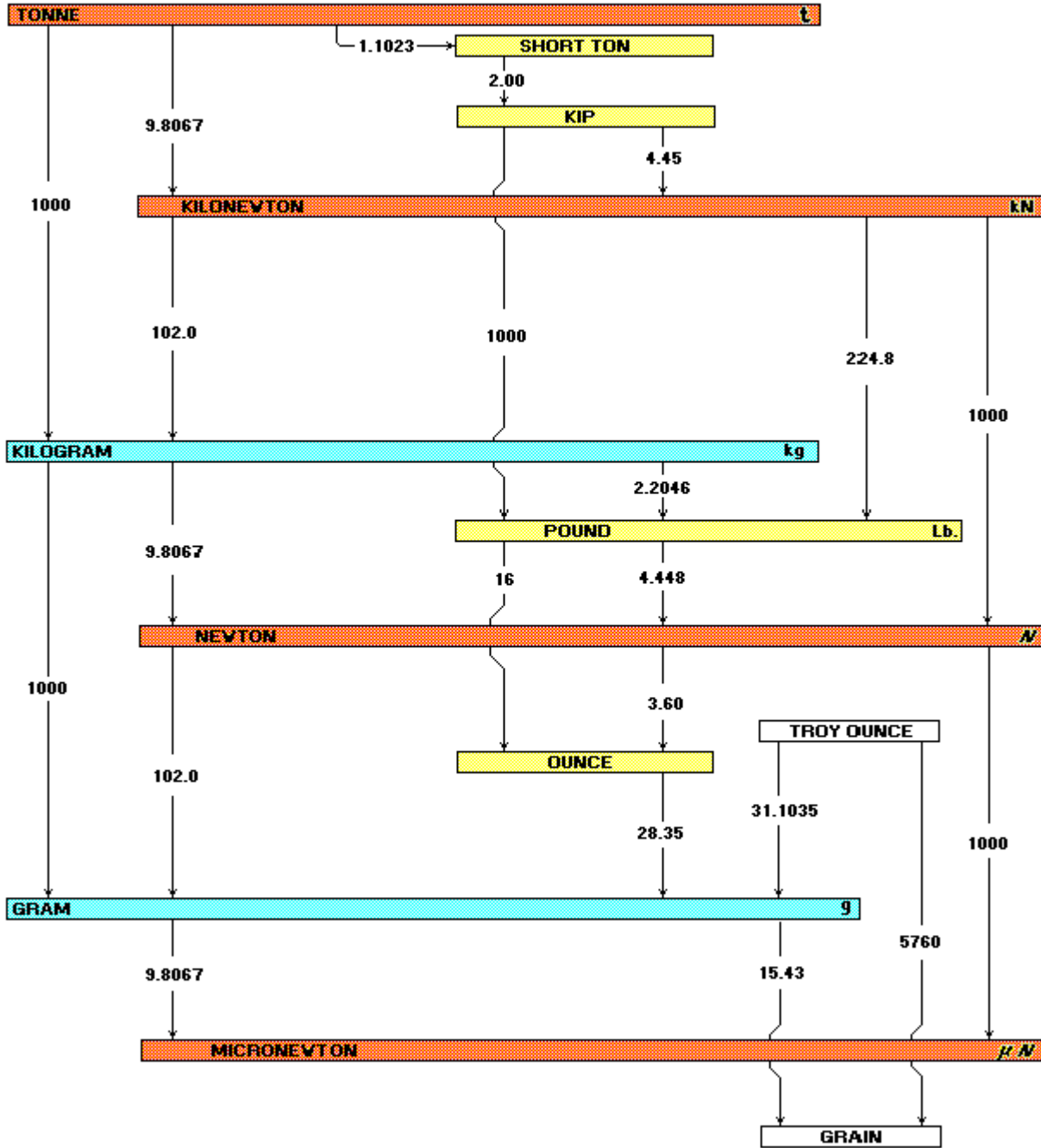

ENERGY

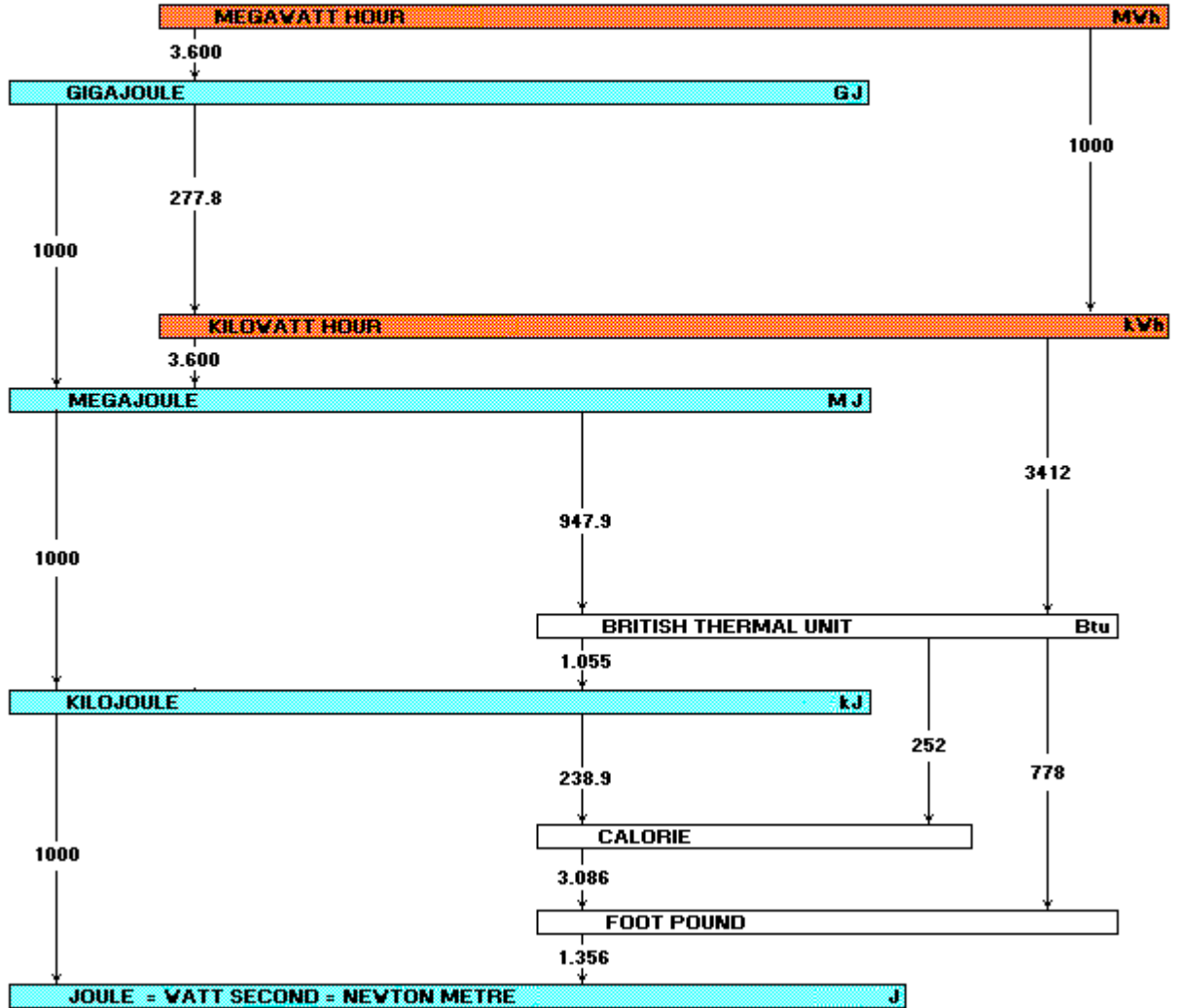

POWER

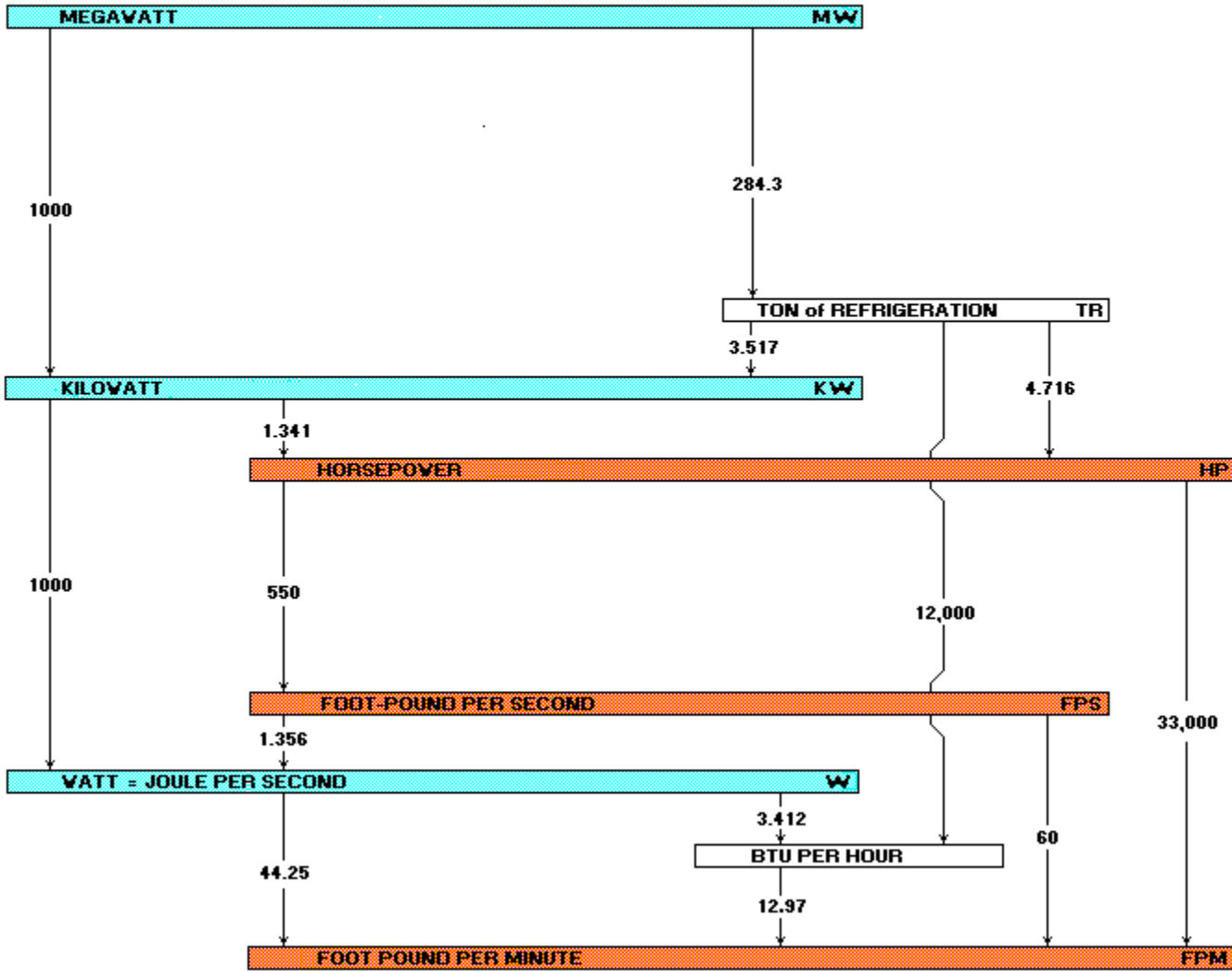

Appendix V – Basic Technical Library

Following is a list of suggested reference texts for a hard rock mining technical library. The texts that are considered classics in the industry (“bibles”) are listed in bold font.

Subject	Author	Title
Introduction	NMPL	Mining Explained (Northern Miner booklet)
Introduction	Placer Dome Inc.	The Mine Development Process (booklet)
Introduction	Hartman	Introductory Mining Engineering
General	Hoover	Principles of Mining
General	Peele	Mining Engineers' Handbook
General	AIME	SME Mining Engineering Handbook
General	EM/J	Operating Handbook of U/G Mining
General	Stantec	Hard Rock Miner's Handbook
Minerals	Dana	Dana's Manual of Mineralogy
Rocks	Pirsson & Knopf	Rocks and Rock Minerals
Geophysics	Telford	Applied Geophysics
Geophysics	Dobrin	Geophysical Prospecting
Geology	McKinstry	Mining Geology
Geotechnical	Krynine & Judd	Principals of Eng. Geol. & Geotechnics
Diamond Drilling	Cummings	Diamond Drill Handbook
Ore Reserves	Parks	Valuation of Mineral Property
Ore Reserves	Lane	The Economic Definitions of Ore
Environment	Corbitt	Std Handbook of Environmental Engineering
Hydrology	Johnson (UOP)	Ground Water and Wells
Open Pit equipment	CAT	Caterpillar Performance Handbook
Open Pit Design	Crawford (AIME)	Open Pit Planning & Design
Pit Slopes	Hoek & Bray	Rock Slope Engineering
Pit Reclamation	Kennedy (AIME)	Surface Mining
Rock Mechanics	Coates	Rock Mechanics Principles
Rock Mechanics	Hoek & Brown	U/G Excavations in Rock
Rockbursts	Spalding	Deep Mining
Adits &Tunnels	Richardson, Mayo	Practical Tunnel Driving, rev 1978
Mine Shafts	IME	London Symposium
u/g Caving Methods	Stewart (AIME)	Design & Op's Caving & Sublevel Stoping
u/g Mining Methods	Hastrulid (AIME)	U/G Mining Methods Handbook
Drilling	Tamrock	Handbook of Underground Drilling
Explosives	ICI, Dupont	Blasters' Handbook
Explosives	Hemphill	Blasting Operations
Mine Safety	INCO	Ontario Div.- All Mines Std. Practice 1977
Rockbolts	Stillborg	Rock Bolting
Shotcrete	ACI	Shotcrete for Ground Support
Backfill	CIM	Mining with Backfill
Backfill	Scoble & Yu	Innovations in Mining Backfill Technology
Crushers	McQuiston (AIME)	Primary Crushing Plant Design
Ore Handling	Edwards	Mine Access Design
Arctic	Johnston	Permafrost Engineering Design & Const.
Sub-Arctic	MacFarlane	Muskeg Engineering Handbook
Soil Mechanics	Terzaghi & Peck	Soil Mechanics in Engineering Practice
Soil Mechanics	Craig	Soil Mechanics
Site Drainage	AISI (culverts, etc.)	Handbook of Drainage & Road Construction
Access Roads	CGRA	Design Stds. for Canadian Roads & Streets
Foundations	CGS	Canadian Foundation Engineering Manual
Foundations	Wintercorn, Fang	Foundation Engineering Handbook
Foundations	Teng	Foundation Design
Architecture	Ramsey/Sleeper	Architectural Graphic Standards
Concrete	CPCA	Concrete Design Handbook

Subject	Author	Title
Concrete	ACI	ACI Manuals of Concrete Practice
Falsework	ACI	Formwork for Concrete
Structural Steel	CISC	Handbook of Steel Construction
Welding	Blodgett	Design of Welded Structures
Headframes	Staley	Mine Plant
Hoists	Broughton	Electric Winders
Gears	East	Hamilton's Gear Book
Conveyors	CEMA	Belt Conveyors for Bulk Materials
Pumps	Ingersoll Rand	Cameron Hydraulic Data
Pumps	Goulds	Goulds Pump Manual
Pumps	Karassik, et al	Pump Handbook
Ventilation	Hartman	Mine Ventilation & Air Conditioning
Ventilation	Floyd Bossard	Manual of Mine Ventilation Design Practices
Ventilation Fans	Daly	Woods Practical Guide to Fan Engineering
Compressed Air	Ingersoll Rand	Compressed Air & Gas Data
Mine Plant	Marks	Std. Handbook for Mechanical Engineers
Mine Plant	Bise (AIME)	Mining Engineering Analysis
Mine Plant	Tillson (AIME)	Mine Plant (Rocky Mountain Series)
Mine Plant	Glover (RMEL)	Pocket Reference (tables & formulae)
Mine Equipment	Andersson, et al	Atlas Copco Manual
Equipment Design	Oberg, et al	Machinery's Handbook
Fire Prev./Insce.	Factory Mutual	Fire Prevention Handbook (NFPA)
Electrical Standards	CSA	Use of Electricity in Mines
Electrical Circuits	Smeaton	Switchgear & Control Handbook
Electric Motors	Smeaton	Motor Application & Maintenance Handbook
Electrical Eng.	Fink & Beaty	Standard Handbook for Electrical Engineers
Comminution	Bond	Crushing & Grinding Calculations
Mill Buildings	AISE	Design & Construction of Mill Buildings
Mill Buildings	Drummond, McCall	Stock List and Reference Book
Mill Design	Denver	Mill Design Handbook
Mill Design	Mular, etc. (AIME)	Mineral Processing Plant Design
Flow Sheets	Denver	Denver Equipment Index
Flow Sheets	CIM	Milling Practice in Canada
Milling	Taggart	Handbook of Mineral Dressing
Milling	Perry	Chemical Engineers Handbook
Mill Reagents	Cyanamid	Mining Chemicals Handbook
Assaying	Bugbee (CSM)	A Textbook of Fire Assaying
Assaying	Young	Chemical Analysis in Extractive Metallurgy
Assaying	McGraw Hill	Handbook of Mathematics & Physics
Tailings	Klohn, Leonoff	Design & Construction of Tailings Dams
Refining	(see assaying)	
Cost Estimating	RS Means	Building Construction Cost Data (USA)
Cost Estimating	Dun & Bradstreet	Cost Guide for Const Equip (Blue Book)
Specifications	NMS	National Master Specs (Canada), Vol 1-14
Purchasing	Fraser	Canadian Trade Directory
Purchasing	Sweets	Canadian Construction Catalogue File
Purchasing	C M Journal	Reference Manual & Buyer's Guide
Purchasing	Thomas	Register of US Manufacturers
Purchasing	McGoldrick	Canadian Customs & Excise
Purchasing	McMaster, Carr	Supply Catalogue (USA)

INDEX

A

AC, 94, 114, 117, 215, 216, 218, 222, 223, 225, 275
 access roads, 42, 48, 51
 Accounting practice, 66
 accruals, 72
 acid rock, 50
 adit, 42, 45, 49, 104, 165, 187, 191, 236
 air blasts, 27, 28, 234
 air leaks, 179, 181
 air temperature, 16, 173, 180
 aircraft payload capacities, 263
 ANFO, 209, 210, 212
 argillites, 3
 assays, 3, 4, 7
 atmospheric pressure, 178, 181, 185, 189
 auto-compression, 157, 172, 178
 azimuth, 18, 102, 152

B

backfill, 13, 14, 16, 37, 38, 42, 50, 152, 163, 201, 202,
 203, 204, 205, 207, 209, 210, 244, 255, 259
 backlog, 269
 ball mill, 236, 247, 251, 252
 ball park estimates, 77
 base metals, 246
 belt width, 151, 153
 bending stresses, 20
 Beneficiation, 246, 254
 big-hole burn cut, 214
 big-hole drilling, 92, 106, 109
 bins, 123, 133, 144, 163, 175, 189, 229, 231, 235, 236,
 247
 bi-polar microscope, 4
 black schist, 3
 blasthole, 18, 35, 36, 37, 40, 41, 44, 63, 100, 177, 209,
 210, 211, 212, 213, 214, 229, 231, 237
 blasthole stoping, 35
 blasting, 15, 16, 20, 38, 94, 160, 162, 163, 201, 209, 210,
 211, 212, 237, 244
 bleeding, 271
 block caving, 14, 16, 36
 Bond's formula, 249, 253
 borehole, 4, 20, 179, 187, 191, 203, 209, 210
 brine, 105, 107, 108, 110, 111, 113, 213, 256
 bucket, 92, 93, 94, 148, 160, 189, 191, 272, 281
 bulk sample, 2, 7, 8
 burst prone ground, 15, 22, 101, 232, 233

C

calcareous rocks, 3
 Canadian Shield, 2, 3, 17, 18, 48, 83, 188
 capex, 67, 74, 79
 capital costs, 7, 47, 54, 58, 68, 71, 77
 cash flow, 55, 57, 60, 67, 68, 69, 70, 72
 centrifugal pump, 85, 109, 113, 188, 189, 192, 193, 194,
 195

centrifuges, 256
 certificates, 280
 chalcopyrite, 2
 CHF, 201, 204, 206
 chilling, 157
 chlorination, 52
 chlorine, 52, 53
 chute, 148, 229, 230, 231, 235, 244
 CIL, 63, 250, 255
 CIP, 63, 250, 255
 circular bald shaft, 10
 circular concrete-lined shafts, 82
 circular shaft, 13, 20, 21, 83, 85, 86, 87, 89, 93
 circulation drilling, 2
 civil engineering, 204
 clastic, 26
 clear water centrifugal pump, 193
 coal, 2, 35, 86, 213, 246
 cohesive soils, 88, 105, 107, 108
 collar, 36, 45, 80, 83, 88, 92, 93, 94, 104, 105, 106, 107,
 108, 109, 110, 111, 112, 127, 132, 137, 143, 144, 146,
 165, 191, 210, 213
 comminution, 163, 234, 246
 commissioning, 288, 289
 commodity market, 66
 compressed air, 93, 95, 157, 163, 169, 170, 175, 178,
 179, 180, 182, 183, 185, 189, 203, 255
 compressive stresses, 20, 22
 compressor capacity, 178
 computer, 4, 8, 67, 69, 70, 118, 149, 150, 151, 152, 153,
 157, 262, 275, 282
 conceptual, 42, 45, 54, 59, 73, 74, 77
 concrete headframe, 143, 145
 concrete lining, 10, 21, 34, 82, 83, 86, 87, 88, 104, 107,
 111, 230, 232
 concrete rings, 9, 10
 concrete shafts, 82, 86
 concrete ties, 262
 condemnation, 6
 cone crusher, 152, 236, 238, 239, 242, 243, 254
 constants, 112, 164
 constructability, 82, 287
 construction management, 79
 contaminants, 53, 152, 171
 contamination, 7, 53, 187, 271
 contract administration, 286
 conversion factors, 113, 163
 conveyance, 64, 82, 84, 85, 93, 114, 116, 117, 118, 125,
 126, 127, 128, 129, 130, 133, 135, 136, 137, 141, 166,
 167, 237
 conveyor, 9, 10, 40, 41, 43, 45, 48, 78, 99, 100, 101, 104,
 123, 133, 137, 144, 149, 150, 151, 152, 153, 154, 155,
 156, 159, 204, 231, 234, 236, 237, 238, 245
 cooling, 27, 114, 157, 158, 161, 163, 174, 175, 176, 178,
 179, 180, 207, 208, 250
 copper, 11, 40, 41, 53, 56, 78, 120, 121, 149, 153, 183,
 217, 222, 246, 249, 250, 254, 263, 276
 core, 4, 7, 8, 13, 14, 15, 20, 22, 24, 108, 135, 278
 Coriolis effect, 128, 234

cost accounting, 77, 284, 286
 cost control, 57, 77, 285, 286
 cost of production, 67, 71
 cranes, 114
 crater blasting, 212
 creep, 21, 26, 64, 94, 118, 119, 120, 124, 265
 CRF, 36, 177, 201, 202, 204, 206, 229, 234, 235
 critical speed, 252
 cross training, 62, 287
 crusher capacity, 238, 240
 crushers, 149, 236, 237, 238, 239, 240, 241, 242, 243, 252
 culvert, 51, 104, 151, 259, , 262, 263
 curvature, 99, 159, 258, 259, 260, 262
 cut-off grade, 7, 50
 cuttings, 4, 7, 28, 179, 214
 cyanide solution, 246, 250, 255
 cycle time, 95, 114, 118, 119, 120, 129
 cyclones, 256

D

Daily Work Schedule, 266, 267
 dam, 199
 DC, 114, 117, 130, 216, 223, 224, 225, 263, 275
 decline, 10, 43, 45, 74, 99, 100, 102, 104, 105, 159
 deep drilling, 4
 demand, 60, 61, 64, 65, 161, 215, 219, 220, 221, 223
 density, 6, 8, 112, 141, 152, 158, 162, 171, 173, 201, 202, 203, 204, 205, 209, 211, 212, 216, 240, 247, 248, 255
 depreciation, 68, 69, 72
 design criteria, 61, 152, 199
 de-stressing, 22
 detailed feasibility study, 54, 57
 development headings, 16, 99, 102, 169, 170, 175, 213
 dewatering, 52, 85, 105, 106, 108, 187, 190, 192, 198, 205, 219, 220
 diamond drill, 2, 3, 4, 7, 13, 15, 20, 24, 182, 220, 221
 diesel, 100, 101, 149, 157, 158, 160, 161, 162, 171, 172, 173, 175, 178, 179, 183, 188, 212, 258, 259, 266, 270, 271, 275
 direct costs, 73, 74, 75, 76
 dirty water pumps, 193
 discing, 15
 discount factor, 67, 69, 70
 discs, 15, 20, 272, 274
 ditch, 48, 51, 102, 106, 162, 175, 187, 189, 190, 191, 192, 193, 194, 262
 document control, 286
 double entry, 9, 10
 double toggle crusher, 241
 DPM, 157, 172
 drag coefficients, 167, 198
 drainage, 10, 51, 187, 193, 194, 205, 257, 260, 262
 drainage tunnels, 193
 drift and fill, 35, 38
 drill and blast, 13, 14, 92, 99, 211, 214, 229
 drill core, 8
 drill hole diameters, 4
 drill holes, 4, 7, 8, 105, 187, 190
 drill pattern, 36, 213
 drill string, 4, 8, 211, 213

drilled shaft, 10, 18, 109
 drive capacity, 240
 drum hoist, 63, 64, 65, 92, 96, 114, 115, 116, 117, 118, 119, 120, 121, 123, 125, 131, 135, 141, 143, 145, 146
 due diligence, 57, 66, 67, 77
 dust control, 47, 48
 dust suppression, 190, 213, 232, 261
 DWS, 266, 267, 279
 dykes, 2, 3, 16, 20, 26, 35
 dynamites, 212

E

earnings, 72
 earthquake, 20, 27, 145
 economic projection, 57, 58
 egress, 9, 10
 elastic, 13, 16, 17, 18, 19, 20, 26, 27, 86, 88
 elastic theory, 17
 electric motor, 161, 180, 217, 223
 electricity, 160, 173, 215
 emissions, 28, 47, 48, 53, 172
 empirical method, 232
 empirical rules, 15
 emulsions, 212
 engineering properties, 8
 environmental engineering, 47
 environmental impact statement, 47, 49
 EPCM, 73, 74, 77, 79
 equipment availability, 268
 equipment life cycle, 269
 equipment roster, 267
 equipment utilization, 268
 erosion, 18, 48, 165
 estimate, 6, 8, 49, 54, 55, 56, 57, 67, 68, 71, 73, 74, 75, 76, 77, 78, 145, 146, 147, 161, 191, 219, 234, 249, 254, 259, 265, 267
 estimation, 2, 162
 expenditure, 6, 9, 57, 67, 72, 74, 79
 exploration, 2, 3, 4, 6, 7, 9, 10, 20, 49, 52, 54, 68, 72, 95, 170, 191
 exploration drilling, 2, 4
 exploration geology, 2
 explosives, 26, 42, 48, 53, 105, 144, 190, 209, 210, 211, 212, 213, 229, 231
 extraction rate, 59, 60

F

FAG, 63, 153, 251, 252
 fans, 78, 157, 159, 160, 161, 162, 163, 164, 165, 170, 220, 221
 fault zones, 20
 feasibility study, 3, 7, 54, 55, 57, 58, 59, 60, 67, 73, 75, 77
 feeder, 63, 149, 150, 152, 156, 231, 244, 283
 financial appraisal, 54, 56
 financial department, 67
 financial evaluation, 66, 67, 68, 69
 fines, 106, 149, 187, 189, 190, 193, 204, 229, 230, 231, 232, 234, 238, 239, 243, 244
 fire fighting, 48
 firm estimates, 77
 fixed guides, 82, 120, 136, 141

- fixed metal price, 71
fleet, 55, 63, 74, 75, 94, 118, 127, 161, 190, 264, 265, 266, 267, 269, 270, 271, 272, 274, 278
flotation, 178, 246, 248, 250, 251, 254, 255
flow capacity, 51
footwall, 3, 4, 35, 36, 38, 44, 231
force majeure, 61
freeze wall, 105, 107, 108, 110, 111, 112, 113
freezing, 82, 83, 92, 104, 105, 106, 107, 108, 109, 110, 111, 112, 113, 157, 164, 180, 213
friction bolt, 14, 22
friction hoist, 64, 65, 114, 125, 126, 127, 128, 129, 131, 135, 137, 141, 143, 144, 145
frother, 255
fuel injectors, 271
full load current, 223, 225
fuse ratings, 226
- G**
- galena, 2
gangue, 50, 251, 254
gears, 114, 116, 242, 282
gemstones, 2
geologic time, 11
geologists, 2, 4
geo-physicists, 2
geo-scientists, 2
geostatics, 3
glaciers, 18
glory hole, 230, 234, 243
gold, 3, 6, 56, 60, 246, 249, 250, 251, 254, 255
gold deposits, 3
grade, 2, 6, 7, 8, 35, 36, 37, 38, 42, 43, 44, 50, 56, 61, 101, 102, 103, 104, 161, 189, 203, 210, 257, 258, 261, 262
gravitational stress, 17
gravity separation, 256
greasing equipment, 271
grinding mill, 247, 251, 254
ground control, 20, 86
ground mount friction hoist, 133
ground support, 8, 13, 15, 16, 20, 21, 27, 37, 99, 102, 105, 204, 232, 235
ground water, 4, 7, 20, 37, 87, 88, 104, 105, 106, 107, 108, 109, 173, 187, 188, 190, 191, 193, 202, 203, 235
ground-freezing, 104, 107, 108
grout, 4, 94, 107, 108, 189
grouting, 8, 20, 73, 83, 86, 87, 108, 187
gyratory crushers, 237, 238, 242
- H**
- hand tools, 278
hanging wall, 23
haul roads, 42, 257, 260, 261
haul trucks, 43, 81, 102, 230, 257, 260, 264, 270
headframe, 10, 48, 59, 63, 80, 92, 94, 104, 126, 127, 128, 133, 134, 137, 143, 144, 145, 146, 147, 165
heat balance, 163, 174, 207
hoist drum, 115, 117
hoist wheel rotation, 115, 126
- hoisting, 9, 10, 43, 45, 46, 63, 64, 82, 84, 93, 95, 114, 115, 117, 118, 119, 120, 121, 122, 123, 125, 126, 127, 128, 129, 131, 132, 135, 137, 140, 143, 145, 151, 160, 161, 164, 168, 237, 239, 245, 283
hoisting capacity, 9, 10, 121, 131
horizontal stress, 17, 18, 19, 83
hot dip galvanizing, 86
hydraulic, 23, 47, 95, 178, 189, 190, 193, 201, 202, 203, 204, 205, 206, 221, 230, 237, 239, 245, 255, 265, 269, 271, 272, 274, 275, 276, 279, 281
hydraulic fill, 201, 204
hydrocarbons, 53, 157, 172
hydrology, 37, 191
hydrothermal genesis, 3
hypochlorinator, 53
- I**
- igneous rock, 3
inclined shaft, 9, 10, 84
indirect costs, 38, 54, 73, 74, 75, 76
induced stress, 17, 18, 19, 20
inferred reserves, 6
infrastructure, 6, 42, 45, 48, 57, 60, 257
intrusion, 3, 26
intrusive, 3
inventory control, 272
IRR, 67, 68, 70
ISO 9000, 270
- J**
- jaw crusher, 63, 149, 152, 153, 237, 238, 239, 240, 241, 242, 243
job descriptions, 268
joint venture, 6, 66, 67
jumbo, 15, 18, 81, 94, 100, 104, 178, 214, 221, 273, 274
jumbo drill, 15, 81
- K**
- Koepe hoist, 64, 65, 125, 127, 134
- L**
- laboratory, 6, 7, 202, 215, 253, 254, 272
laser beams, 102
laser survey controls, 102
lateral development, 9, 99, 101
lateral deviation, 234
leaching, 246, 250, 254, 255
lead, 49, 53, 55, 56, 60, 74, 76, 108, 128, 177, 229, 239, 246, 250, 254, 269
LHD, 9, 10, 36, 41, 44, 74, 80, 81, 93, 99, 100, 101, 102, 148, 157, 161, 172, 178, 207, 229, 237, 243, 244, 264, 269, 270, 273, 275, 279, 281
liquid nitrogen, 105, 107, 108
lithological stress, 17
locomotive, 100, 101, 258, 259, 262
logs, 4, 8, 269, 280
longhole open stoping, 35
lubricants, 53, 264, 274, 282, 283

M

magnetite, 2
 Maintenance Department, 148, 264, 265, 266, 269, 270, 273, 278
 major axis, 17
 manpower utilization, 268, 269
 manway, 9, 95, 162, 166
 materials handling, 42, 46, 229, 244
 meetings, 287, 288
 mercury, 49, 246, 254
 metal prices, 7, 56, 66, 71
 metallic ores, 2, 35, 246, 255
 metallurgy, 8
 mill, 2, 8, 10, 35, 38, 44, 47, 48, 50, 53, 56, 60, 63, 78, 144, 153, 178, 189, 202, 204, 205, 215, 222, 233, 234, 236, 246, 247, 248, 249, 250, 251, 252, 253, 254, 255, 256
 mine closure, 16, 68, 145
 Mine Closure Study, 49
 mine efficiency, 269
 mine entries, 9, 16, 50
 mine layout, 42, 44, 50, 257
 mine maintenance, 264, 268, 269, 270
 mineral economics, 60, 66
 mineral hardness, 11
 mineral processing, 246, 247, 251
 mineral reserves, 2
 mineralization, 3, 4, 7, 8, 38, 57
 minerals, 2, 13, 37, 56, 67, 246, 250, 253, 254, 255
 mining engineer, 2, 67
 mining methods, 7, 8, 16, 35, 36, 37, 38, 39, 44, 63, 158, 205, 212, 229, 231, 237, 244
 mobile equipment, 45, 74, 99, 101, 151, 161, 178, 180, 183, 264, 265, 267, 268, 270, 272, 276
 monolithic, 9, 10, 101
 multiplexor, 28

N

natural gas, 160, 173
 natural ventilation, 165
 nickel, 56, 60, 246
 nitrates, 53
 noise attenuation, 47
 NPV, 60, 61, 67, 68, 69, 70

O

OEM, 265, 266, 270, 272, 282
 oil changes, 53, 270
 on-board diagnostic, 269, 279
 open pit mine, 2, 42, 215
 open pits, 13, 27, 42, 209, 210, 237, 242
 operating cost, 37, 38, 56, 61, 67, 68, 71, 72, 77, 99, 149, 157, 202, 215, 239, 245, 247, 250, 265
 Order-of-Magnitude Feasibility Studies, 54
 ore handling, 38, 42, 101, 122, 133, 151, 163, 237
 ore passes, 40, 41, 204, 229, 231, 232, 233, 234, 237, 243
 ore reserves, 2, 3, 5, 6, 7, 8, 43, 57, 59, 70, 83
 ore transport, 45, 46
 ore volume, 6

ore zone, 4, 37, 45, 164
 orientation, 4, 16, 17, 18, 23, 85, 103, 203, 273
 outcrop, 4, 10, 43, 83, 104
 overbreak, 91, 93, 94, 98, 106, 109, 111, 210, 232
 overburden stress, 17
 overwind, 94, 116, 117, 137, 147

P

paste fill, 36, 44, 47, 202, 203, 204, 205, 206, 207, 208, 255
 paving, 260
 payback, 60, 70, 71
 pegmatite, 2
 penetration rate, 4, 213
 permeability, 83, 106
 Peru, 2, 227
 pillar design, 14
 pillars, 14, 16, 20, 22, 36, 38, 201, 204, 229
 pitch distance, 115
 planning and control system, 266
 Planning Control Department, 266, 267
 plugger, 18, 182, 191
 plumb line winches, 114
 PM, 34, 266, 269, 270, 271, 272, 281
 pollution, 47
 polymetallic, 56
 portal, 10, 45, 92, 104, 105, 107, 165, 213
 Post Pillar, 38
 power consumption, 64, 81, 125, 158, 189, 215, 222, 240, 247, 249, 252, 254
 power grid, 64, 65, 227, 228
 power requirements, 154, 222
 precious metals, 246, 254
 Preliminary Feasibility Study, 54, 57
 primary crushers, 236, 240
 process water, 47, 50, 53, 157, 189, 247, 250
 procurement, 74, 79
 production availability, 121, 131
 production capacity, 56, 59, 67, 68, 135, 155, 203
 production costs, 72
 production shaft, 10, 43, 46, 82, 84, 85, 104, 159, 164, 165, 166, 168, 243
 professional engineers, 2
 profits, 69, 71, 72, 264
 project management, 74, 284, 285
 project manager, 95, 96, 284, 286, 288
 propane, 160, 173
 property value, 6
 pyrite, 2, 246, 250

Q

quality assurance, 284, 285, 286
 quantity take-off, 73, 75

R

radiation, 49, 105, 112, 157
 rail haulage, 101, 243, 262
 railway, 262

- ramp, 9, 10, 38, 42, 43, 45, 46, 49, 54, 84, 99, 100, 101, 102, 104, 105, 106, 109, 122, 131, 162, 165, 187, 190, 191, 233, 236, 264, 265, 273
- ramp access, 10, 46, 84, 273
- Randfontein mine, 7
- rate of advance, 10, 81, 92, 96, 101
- rate of return, 55, 60, 61, 66, 67, 70, 71
- rate of safe return, 69
- reclamation, 47, 49, 72
- recycling, 47, 48, 53, 187, 251
- refinery, 8, 56, 246, 271
- refining, 58, 246
- refrigerant, 95, 108, 176
- refrigeration, 105, 110, 111, 112, 113, 160, 161, 164, 174, 175, 176
- regression analysis, 60
- reserves, 2, 3, 8, 37, 39, 56, 59, 60, 67
- residual stress, 17
- resin, 14, 15, 21, 22, 105, 231
- restoration, 6
- return on investment, 56, 59, 66, 70
- rib pillar, 15, 16
- ricochet, 234
- ring stress, 18
- risk, 2, 43, 44, 56, 60, 61, 69, 70, 71, 75, 212, 231, 272
- risk analysis, 60, 61
- risk rate, 69, 70
- risk reduction, 2
- risk-based system, 272
- road design, 260
- rock bolt, 8, 10, 13, 14, 15, 20, 21, 22, 27, 36, 93, 95, 101, 149, 231, 236
- rock foliation, 15, 83
- rock hardness, 12
- rock mechanics, 8, 13, 16, 17, 19, 23, 28, 44, 85, 229, 273
- rock qualities, 4
- rockbreaker, 182, 221, 236, 237, 239, 244, 245
- rockbursts, 15, 16, 17, 21, 22, 26, 27, 28, 34
- Room and Pillar, 35, 36, 38
- rope diameter, 65, 115, 116, 117, 126, 127, 128, 135, 136, 140
- rope guides, 10, 82, 84, 120, 128, 136, 141, 159
- rope pull, 94, 115, 135, 215
- rope stretch, 126, 135, 142
- rope tensioners, 114
- ropes, 36, 64, 82, 85, 93, 94, 115, 116, 117, 122, 125, 126, 127, 128, 129, 130, 132, 134, 135, 136, 137, 138, 141, 168, 204, 283
- routine maintenance, 64, 264, 265, 266, 267, 268, 270, 271, 272, 274, 279
- RQD, 8, 15, 24, 25, 26
- rubber belts, 156
- rules of thumb, 46, 77, 90, 158, 165, 178, 180, 209, 231, 243, 260, 262, 264, 284
- run-of-mine ore, 237
- S**
- safety, 37, 43, 62, 64, 90, 96, 101, 102, 108, 111, 119, 127, 138, 139, 141, 150, 163, 209, 224, 232, 233, 242, 257, 265, 269, 273, 285, 286, 287, 290, 291
- safety officer, 286, 287
- safety training, 269
- SAG, 63, 153, 154, 251, 252
- salt, 2, 27, 35, 110, 174, 246
- salvage value, 55, 64, 68, 75
- sample work standard, 281
- samples, 4, 7, 8, 14, 49, 272, 274
- sampling, 2, 8, 172
- scheduling, 73, 75, 79
- schistosity, 15, 83
- seismic, 18, 19, 20, 26, 27, 28, 34, 143, 145, 233
- sensitivity analysis, 71
- service lines, 9
- shaft lining, 34, 83, 86
- shaft sinking, 9, 20, 22, 80, 81, 82, 85, 86, 87, 91, 92, 93, 94, 95, 118, 119, 120, 134, 136, 140, 141, 142, 145, 162, 170, 212, 213, 214
- shaft stations, 80, 84, 85
- shear, 14, 20, 21, 26, 83, 156, 241
- sheaves, 94, 116, 118, 122, 127, 133, 135, 138, 140, 145, 146
- shop facility, 265, 273
- shotcrete, 21, 27, 86, 165, 178, 230, 232
- side study, 55, 63, 114, 125
- sills, 3, 15, 16, 20, 22, 101
- silver, 3, 56, 66, 246, 250, 254, 255
- single toggle crusher, 241
- skip factor, 140
- slabby ground, 15
- slimes, 187, 189, 190, 192, 204, 248, 250, 281
- slip faults, 3
- slope stability, 13, 48
- sloughing, 14, 20, 36, 87, 107, 109, 201, 230, 231, 235
- sludge, 4, 7
- slurries, 212
- slurry, 6, 105, 107, 177, 190, 193, 196, 202, 204, 205, 209, 255
- slushers, 114, 178
- smallest mining units, 3
- smelter, 8, 53, 55, 56, 205, 246, 248, 250, 251, 255
- smelting, 246
- soda ash, 35, 250, 254
- soil mechanics, 85, 88, 110
- South Africa, 22, 41, 86, 95, 120, 136, 140, 161, 174, 176, 178, 179, 188, 227, 232, 270
- specific gravity, 2, 17, 152, 198, 209, 256
- sphalerite, 2
- split-set, 14, 21, 22, 36
- stage winches, 94, 114
- statistics, 3, 7, 8, 61, 71, 267, 268, 269
- stock items, 276
- stope, 8, 14, 15, 16, 22, 23, 27, 28, 34, 35, 36, 37, 38, 40, 41, 43, 44, 61, 78, 160, 162, 174, 175, 201, 202, 203, 204, 205, 212, 255
- stress, 8, 13, 15, 16, 17, 18, 19, 20, 22, 25, 26, 27, 28, 34, 38, 83, 86, 87, 88, 101, 116, 127, 174, 188, 197, 201, 209, 229, 230, 232, 233, 243
- strike, 2, 3, 15, 22, 27, 61, 83, 259
- strike and dip, 3
- structural integrity, 8, 201
- Styrofoam, 36, 204
- sublevel caving, 36, 38
- subsidence, 14, 20, 37, 201

sulfide, 3, 35, 36, 50, 141, 213, 231, 246, 255
 sulfur blast, 213
 sumps, 187, 192, 204
 surface drilling, 3, 7, 8

T

tailings, 6, 38, 42, 44, 47, 50, 202, 204, 255
 taxes, 58, 59, 69, 72
 tectonic stress, 17
 tensile strength, 14, 21
 test pits, 2
 timber, 9, 27, 34, 80, 83, 85, 86, 92, 93, 95, 104, 135, 137, 143
 TLV, 171
 tomography, 4
 tower mount friction hoist, 134
 trackless, 10, 37, 45, 74, 99, 100, 101, 102, 157, 158, 162, 172, 175, 183, 189, 264, 273
 Trackless Entry, 10
 trackless headings, 101
 training, 58, 151, 268, 269, 278
 transmission line, 219, 224
 transportation, 68, 72, 95, 257
 truck haulage, 10, 43, 63, 102, 149, 236, 262
 tuggers, 114
 turbulence, 52, 152, 165, 166

U

underground development, 3, 73, 244
 underground entry, 2, 7, 49, 54, 187
 underground exploration, 2, 7, 8, 9
 underwind, 116, 132
 uplift, 18, 105

V

value engineering, 77, 285, 287
 variance analysis, 71

Variogram, 7
 VCR, 35, 37, 212, 269
 vehicle check, 279
 vent duct, 9, 94, 102, 162
 ventilation, 9, 10, 16, 42, 43, 44, 82, 83, 84, 85, 87, 100, 102, 103, 104, 114, 138, 157, 158, 159, 160, 161, 162, 163, 164, 165, 166, 168, 169, 170, 171, 172, 173, 174, 175, 176, 190, 201, 217, 270
 ventilation ducts, 169
 ventilation shaft, 84, 87, 159
 vertical faults, 15
 vertical shafts, 9, 10, 82
 vertical stress, 17, 18
 virgin stress, 17
 visco-elastic, 88
 visitors, 285, 290, 291
 volcanic, 2, 3, 48, 211

W

wall thickness, 111, 197, 198
 waste oil, 53
 water balance, 190, 248
 water demand, 52
 water flow, 106, 189, 191, 192
 water pressure, 93, 189, 237
 wood guides, 84, 85, 114
 wood ties, 258, 259, 262
 work index, 8, 215, 234, 253, 269
 work order, 267
 Work Practice, 264, 270
 work standards, 267
 working capital, 68, 72, 77

Z

zinc, 53, 56, 60, 66, 86, 94, 102, 246, 250, 255
 zonal mineralogy, 2